



Compact NSX Compact INS/INV Masterpact NW DC - DC PV

Catalogue 2018

Power circuit breakers and
switch-disconnectors
direct current from 16 to 4000 A



• WEB2 cat.2018

schneider-electric.com

Life Is On

Schneider
Electric



Green Premium™

Endorsing eco-friendly products in the industry



Green Premium™ Product

Green Premium is the only label that allows you to effectively develop and promote an environmental policy whilst preserving your business efficiency. This ecolabel guarantees compliance with up-to-date environmental regulations, but it does more than this.

Over 75% of Schneider Electric manufactured products have been awarded the Green Premium ecolabel



Discover what we mean by green ...

Check your products!

Schneider Electric's Green Premium ecolabel is committed to offering transparency, by disclosing extensive and reliable information related to the environmental impact of its products:

RoHS

Schneider Electric products are subject to RoHS requirements at a worldwide level, even for the many products that are not required to comply with the terms of the regulation. Compliance certificates are available for products that fulfil the criteria of this European initiative, which aims to eliminate hazardous substances.

REACH

Schneider Electric applies the strict REACH regulation on its products at a worldwide level, and discloses extensive information concerning the presence of SVHC (Substances of Very High Concern) in all of its products.

PEP: Product Environmental Profile

Schneider Electric publishes complete set of environmental data, including carbon footprint and energy consumption data for each of the lifecycle phases on all of its products, in compliance with the ISO 14025 PEP ecopassport program. PEP is especially useful for monitoring, controlling, saving energy, and/or reducing carbon emissions.

EoLI: End of Life Instructions

Available at the click of a button, these instructions provide:

- Recyclability rates for Schneider Electric products.
- Guidance to mitigate personnel hazards during the dismantling of products and before recycling operations.
- Parts identification for recycling or for selective treatment, to mitigate environmental hazards/ incompatibility with standard recycling processes.

Compact NSX, Compact INS/INV and Masterpact NW direct current

A complete DC offer from 16 to 4000 A

Compact NSX, Compact INS/INV and Masterpact NW direct current (DC) circuit breakers are used to protect and control low-voltage distribution systems.

They are installed in main low-voltage switchboards (MLVS) and in distribution switchboards (as incomers and outgoers). They can use all the accessories and auxiliaries for the AC ranges and are thus suitable for most DC systems and applications.



A complete DC offer

Compact NSX DC from 16 to 1200 A

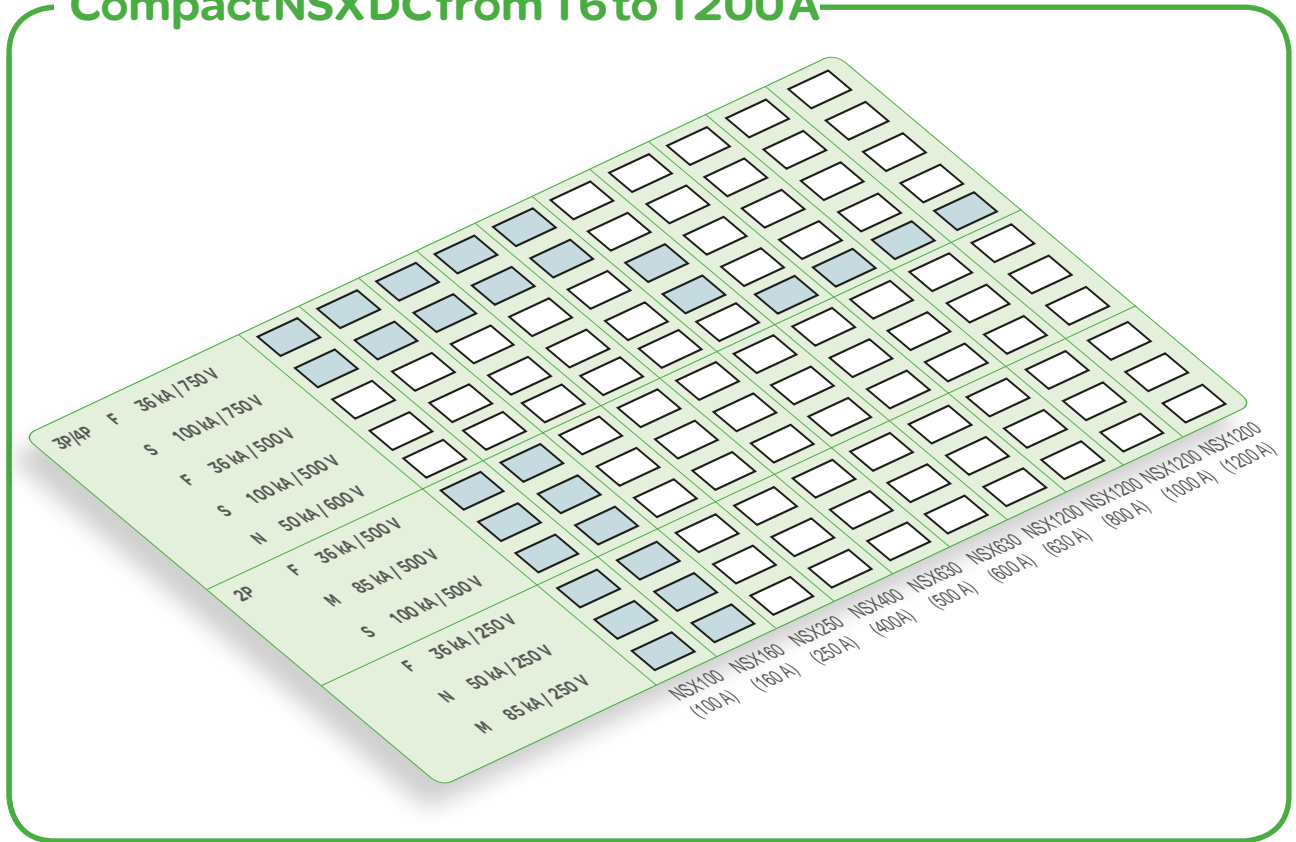

The Compact NSX range is designed for DC voltages from 24 to 750 V and offers:

- a wide selection of models suited to many applications:
 - 1, 2, 3 and 4 poles up to 160 A
 - 3 and 4 poles from 250 to 630 A
 - 2 poles from 630 to 1200 A
- high breaking capacities, with four performance levels F, N, M and S:
 - F
 - 36 kA in a 1 pole version, for systems ≤ 250 V
 - 36 kA in a 2 poles version, for systems ≤ 500 V
 - 36 kA in a 3 or 4 poles version, for systems ≤ 750 V
 - N
 - 50 kA in a 1 pole version, for systems ≤ 250 V
 - 50 kA in a 2 poles version, for systems ≤ 600 V
 - M
 - 85 kA in a 1 pole version, for systems ≤ 250 V
 - 85 kA in a 2 poles version, for systems ≤ 500 V

- S
 - 100 kA in a 2 poles version, for systems ≤ 500 V
 - 100 kA in a 3 or 4 poles version, for systems ≤ 750 V
- fewer frame sizes: just two poles pitches (35 and 45 mm) for easy integration in installation systems (enclosures, machines, etc.)
- accessories for insulation and series or parallel connection of poles, suited to the particularities of DC applications
- fixed and withdrawable versions (3 and 4 poles, DC type).

Breaking capacity I_{cu} for 250 V per pole and L/R = 15 ms⁽¹⁾

(1P: 250 V, 2P: 500 V, 3P: 750 V)

(1) L/R = time constant of the distribution system (see page A-11).



NSX160 DC - 1P.



NSX160 DC - 2P.



NSX250 DC - 3P.



NSX630 DC - 3P.



NSX1200 DC - 2P.

from 16 to 4000 A

Masterpact NW DC from 1000 to 4000 A

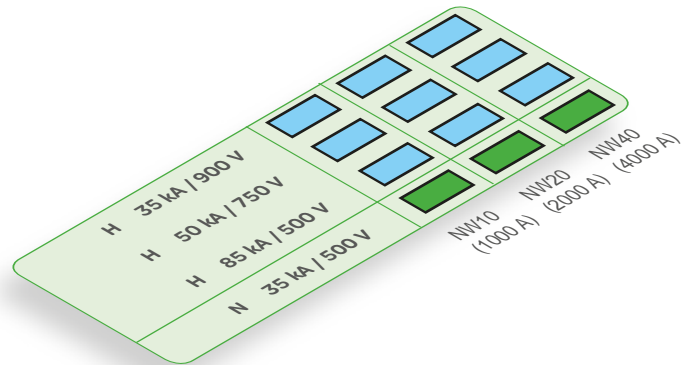

The Masterpact NW range is designed for DC voltages from 24 to 900 V and offers:

- 2 versions : C/D (3 poles)
E (4 poles)
 - three current ratings: 1000, 2000 and 4000 A
 - two high breaking-capacity levels N and H.
- Breaking capacity I_{cu} for L/R = 15 ms ⁽¹⁾ for 500, 750 or 900 V system voltages:
- N
 - 35 kA for systems \leq 500 V
 - H
 - 85 kA for systems \leq 500 V
 - 50 kA for systems \leq 750 V
 - 35 kA for systems \leq 900 V
 - two models:
 - circuit breaker for the protection of power circuits and loads
 - switch-disconnector for circuit control and disconnection
 - fixed and drawout versions for the entire range.

⁽¹⁾ L/R = time constant of the distribution system (see page A-11).



NW10 DC - C/D Version.

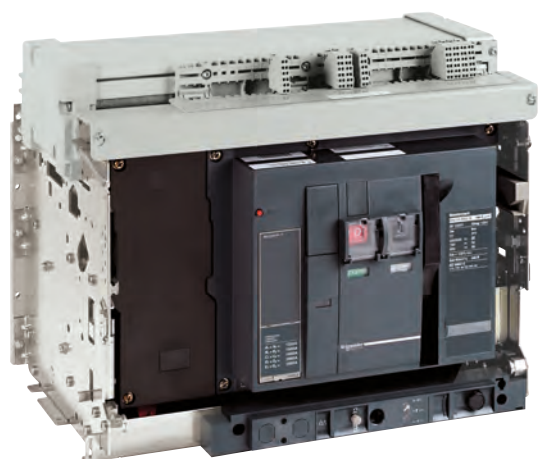

NW10 DC - E Version.



Compact NSX DC PV, Compact INS PV and Masterpact NW DC PV

A complete DC offer for solar application from 80 to 4000 A



Compact NSX DC PV

circuit breakers and switch-disconnectors



Ensuring the reliability and the efficiency of your photovoltaic installation

Schneider Electric photovoltaic packages give you dependable, clean, and affordable solar power. High quality, highly efficient, and available everywhere, our systems are safe, simple-to-install, giving you a competitive edge. The Compact NSX DC PV range of molded case circuit breakers and switch-disconnectors with operational voltage up to 1000 V DC includes the switchgears and the protection components you need to guarantee the safety and operation efficiency of your photovoltaic installation in commercial buildings and power plants.



With heatsinks supplied as standard, the circuit breaker or switch-disconnector rating is optimized, avoiding the need to oversize protection components and saving space in the enclosure. As part of the Compact NSX range, all existing auxiliaries and accessories are compatible. The terminal shields and phase barriers are available for insulation. The shunt trip auxiliary is available for remote disconnection.



Compact NSX DC PV
with short heatsinks



Compact NSX DC PV
with long heatsinks

Compact INS PV switch-disconnectors



No matter the size or scale of the project, Schneider Electric, has a photovoltaic solution to fit your needs. Fast ROI, high efficiency – it's all a part of our offer as the world leader in energy management.

The INS PV-1 is a direct current switch disconnecter dedicated to array isolation and control with V_{oc} until 600 V DC.

Photovoltaic applications



Masterpact NW HADCD-PV switch-disconnectors



Schneider Electric's Masterpact NW HADCD-PV switch-disconnectors are used for circuit control and disconnection.

Safer photovoltaic energy generation



Architecture overview

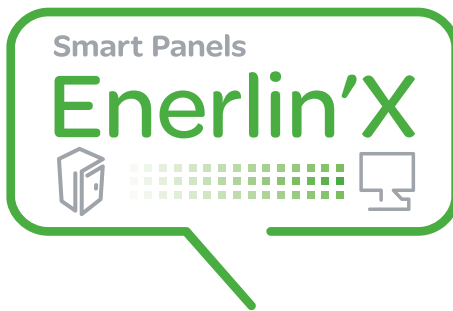

Ethernet-ready Smart Panels

Ethernet-ready Smart Panels enable electrical distribution control and expertise. 'Protect' - 'Measure' - 'Connect' are the 3 pillars of their technology.

PB115759.jpg



4- Act

3- Connect

Give a voice to the panel

Safe Ethernet network data transmission is now part of the intrinsic design of protection and metering devices

2- Measure

Keeping a close eye on energy flows

The switchboard plays a key role in capturing building-related data, by gathering the critical protection and metering components.

1- Protect

Electrical protection is at the core of Smart Panel

Reliable and high-performance technology is present in every breaker and every residual current device.

Architecture overview

Future savings, peace-of-mind

Access to Smart Panel status, values, is essential for taking advantages of monitoring and management services, locally or remotely.

Act in small/medium buildings

with FDM 128, Com'X 510, Power View, EcoStruxure™ Facility Expert

PB11801-60.eps



Electrical device monitoring and control with FDM 128, locally



Optimizing energy-efficiency

- Visualize, record energy consumption and WAGES.
- Comply with regulation .

DD385918.ai

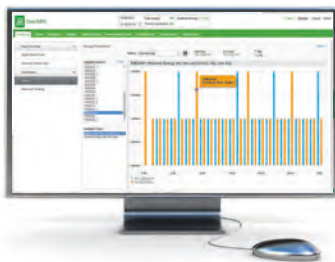

Com'X 510 web pages direct display, or Cloud based pages from other devices with Power View.



Improving continuity of service

- Get instant notifications
- Manage with assets-maintenance platform
- Get and analyze data for quick crisis-recovery

DD385919.ai



Distance management with EcoStruxure™ Facility Expert on Smartphone, tablet, PC



Increasing maintenance efficiency

- Operate preventive maintenance tools
- Follow maintenance & planning
- Provide business owner instant access to maintenance reports

Architecture overview

Day-to-day energy management

>> Power availability & quality, energy performance

For simply dealing with building user's needs and energy constraints.

EcoStruxure™ Building Management provides electrical management, monitoring and energy accounting.

Energy decisions are often crucial in large critical buildings, they must be informed.

EcoStruxure™ Power Monitoring Expert (software for PC) collects Smart Panels values to provide expert analysis.

Act in large non-critical buildings

with EcoStruxure™ Energy Expert



Managing equipment & key assets

- Check operating status, faults on custom on-line diagrams.



Monitoring electrical network

- Observe voltage disturbances, harmonics on graphics.
- Read power factor.



Accounting energy

- Record power meter data on dashboards.
- Allocate energy consumption with costs.
- Follow conservation goals.

Act in large critical buildings

with EcoStruxure™ Power Monitoring Expert [1]



Analysing Power Events

- Speed up downtime crisis recovery
- Determine incident root cause, events sequence.
- Troubleshoot power quality issues.



Monitoring Power quality

- Be alerted of equipment affected by power quality issue.
- Compare power quality against industry standards.
- Collect facts for future discussion with Utility.



Analysing Energy Performance

- Evaluate building energy saving performance;
- Identify underperforming loads;
- Analyze Energy Conservation Measures (ECMs) according ISO50001 program.



[1] EcoStruxure™ Power Monitoring Expert, <http://pmedemo.biz/web/>
ID: demo & Password: demo

General contents

Compact NSX DC - DC PV
Compact INS/INV DC - DC PV
Masterpact NW DC - DC PV

Presentation

Functions and characteristics

Installation recommendations

Dimensions and connection

Electrical diagrams

Additional characteristics

Catalogue numbers and order form

A

B

C

D

E

F

The benefits of a comprehensive and optimised range design...

Compact NSX and Masterpact NW DC - DC PV circuit breakers constitute a flexible and cost-effective means to meet the various needs of DC systems.



NSX250 DC rating plate.

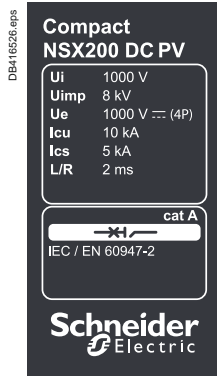

NSX200 DC PV rating plate.

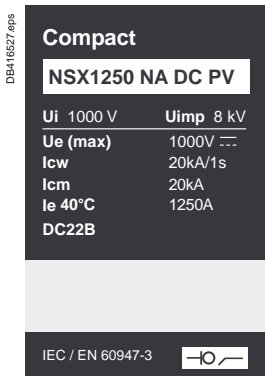

NSX1250 NA DC PV rating plate.

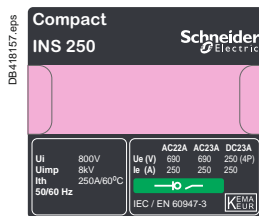

INS 250 rating plate.

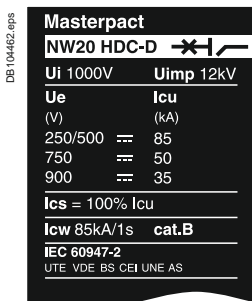

NW20 HDC-D rating plate.

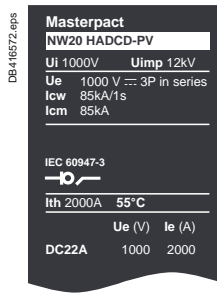

NW20 HADCD-PV rating plate.

A wide, complete and high-performance range

Schneider Electric DC - DC PV circuit breakers and switches provide a comprehensive solution for the many applications met in DC systems. The Compact NSX and Masterpact NW DC ranges offer, a wide selection of current ratings (16 to 4000 A) and breaking capacities (up to 100 kA) for the common voltages up to 900 V DC. The Compact NSX and Masterpact NW DC - DC PV ranges are designed for use under 1000 V for photovoltaic application. The Compact INS/INV offers a wide selection of current ratings (40 to 2500 A) for the common voltage up to 250 V DC.

Flexible and optimised design

The Compact NSX, Compact INS/INV and Masterpact NW DC ranges use all the standard accessories and auxiliaries of the AC ranges. The modular design and many possibilities offered by these systems provide a high degree of flexibility in customizing products, while benefiting from dependable and optimised industrial design.

Safe and simple operation

Even though they use the accessories of the corresponding AC ranges, the Compact NSX, Compact INS/INV and Masterpact NW DC ranges have been specially designed for DC systems. Specific accessories have been developed to meet the needs of series or parallel connection of poles by users in a simple and dependable manner (see page opposite). Compact NSX, Compact INS/INV and Masterpact NW DC devices can be installed in class II switchboards with a degree of protection up to IP54.

Compliance with standards

Compact NSX, Compact INS/INV and Masterpact DC circuit breaker ranges comply with:

- the main international standards and in particular IEC 60947-1/2/3
- European (EN 60947-1 and EN 60947-2) and the corresponding national standards: France NF, Germany VDE, UK BS, Australia AS, Italy CEI
- the specifications of the marine classification companies (Veritas, Lloyd's Register of Shipping, Det Norske Veritas, etc.)
- French standard NF C 79-130 and the recommendations issued by the CNOMO organisation for the protection of machine tools. For United States UL, Canadian CSA, Mexican NOM and Japanese JIS standards, please consult us.

Compact NSX, Compact INS/INV and Masterpact NW DC - DC PV switches and auxiliaries comply with the following:

- the main international standards and in particular IEC 60947-2 (circuit breaker), IEC 60947-3 (switch-disconnectors)
- European (EN 60947-1, EN 60947-2 and EN 60947-3) and the corresponding national standards: France NF, Germany VDE, United Kingdom BS, Australia AS, Italy CEI.

Open communication

Compact NSX and Masterpact NW DC devices can be equipped with communication options for integration in a supervision system via Modbus.

Pollution degree

Compact NSX and Masterpact NW DC circuit breakers are certified for operation under pollution conditions in industrial environments, as per standard IEC 60947, corresponding to:

- pollution degree 3 (Compact NSX, Compact INS/INV)
- pollution degree 4 (Masterpact NW).

Tropicalisation

Compact NSX, Compact INS/INV and Masterpact NW DC circuit breakers have successfully passed the tests prescribed by the following standards for extreme atmospheric conditions:

- IEC 60068-2-1 - dry cold (-40 °C)
- IEC 60068-2-1 - dry heat (+85 °C)
- IEC 60068-2-30 - damp heat (95 % relative humidity at +55 °C)
- IEC 68-2-52 (level 2) - salt mist.

Environmental protection

Schneider Electric circuit breaker ranges benefit from Eco-design:

- use of materials not representing a danger to the environment
- non-polluting production units complying with ISO 14001 standards
- filtered breaking for high current ratings to avoid pollution in the switchboard
- low dissipated energy per pole, making energy losses insignificant
- marking of products in view of sorting recyclable materials at the end of the service life.

... specifically for DC - DC PV applications

Designed for direct current

Performance levels and quality signed Schneider Electric

The creation of a dependable and high-performance DC range requires a large amount of specific design and development work in addition to that invested in the original AC range.

Schneider Electric called on its proven industrial experience in the AC field and its recognised know-how in current interruption to develop a high-performance DC range.

Schneider Electric decided to use the cases and accessories of its Compact NSX and Masterpact NW ranges with:

- a high-performance design for the breaking chambers or the poles intended specifically for DC applications (e.g. 100 kA at 250 V per pole for Compact NSX and 85 kA at 900 V for two poles for Masterpact NW)
- fast trip units developed for DC applications
- optimised pole-connection and isolation possibilities that are both simple and dependable.

Optimised solutions for the many types of DC systems

The many types of DC systems make it necessary, for cost and technical-optimisation reasons, to connect the poles of two, three or four-pole circuit breakers in series or in parallel.

- The Compact NSX and Masterpact NW ranges enable series connection of poles, thereby optimising breaking capacity for high voltages.

Series connection reduces the voltage across the terminals of each pole (the total voltage is divided by two, three or four depending on the circuit breaker) and the operation of all poles provides the breaking capacity of the overall device.

This makes it possible to break short-circuit currents at high voltages while optimising solutions (e.g. a Compact NSX 100 kA 250 V per pole can be used on a 750 V system with three poles connected in series, thus reducing the cost compared to a 750 V solution).

- The Compact NSX range enables parallel connection of the poles, thereby optimising the use of the rated currents.

Optimised and dependable series or parallel connection of poles

Series connection - controlled temperature rise and guaranteed performance

Schneider Electric DC circuit breakers comply with product standards IEC 60947-1 and 2.

To that end, series connection of poles meets:

- temperature-rise conditions. Connections specifically designed to dissipate heat mean the thermal model is equivalent to that for AC applications. The devices dissipate the temperature rise produced by relatively short series connections
- optimum safety conditions. Connections are designed for extreme operating conditions (insulation and safety clearances, ultimate breaking capacity, high pollution levels, etc.).

Parallel connection - optimisation

Certain DC systems require high power levels (hundreds to thousands of amperes) at reduced voltages, most often ≤ 250 V.

The configurations of DC systems and the exceptional performance levels of Compact NSX circuit breakers mean the poles can be parallel connected.

This technique virtually doubles, triples or quadruples the current rating depending on the type of circuit breaker and thus reduces the cost of solutions.

Compact NSX DC and Masterpact NW DC circuit breakers offer optimised pole-connection possibilities.

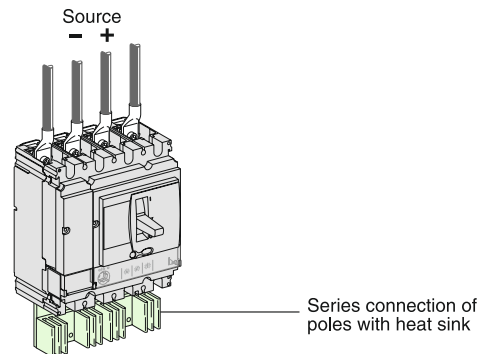

Compact NSX DC - safety and flexibility.

DB430775.eps

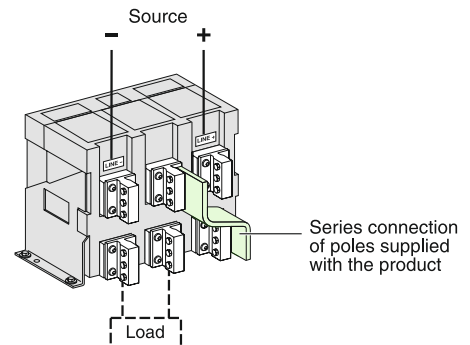

Masterpact NW DC - supplied ready for installation (here with vertical rear connections).

DB430776.eps

Presentation

Great flexibility in adapting to DC applications

Overview of series connection of poles for Compact NSX DC

With Compact NSX DC circuit breakers, it is easy to create a large number of series pole arrangements using prefabricated connections mounted on site during equipment installation.

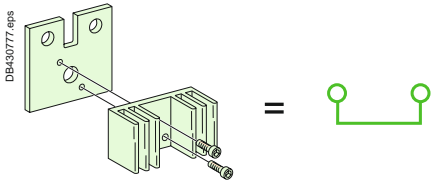

One type of connection per framesize, two catalogue numbers for all series connections.

Compact NSX DC

Examples of series connection

Two-pole devices

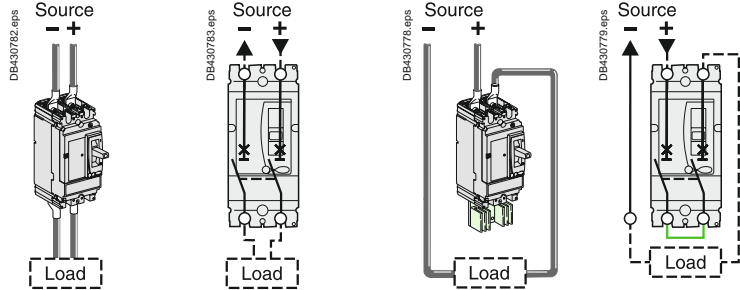

Three-pole devices

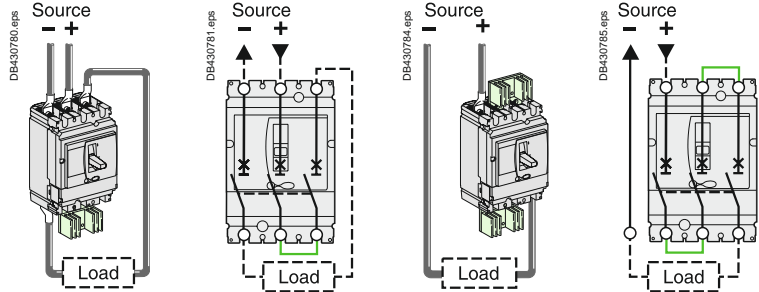

Four-pole devices

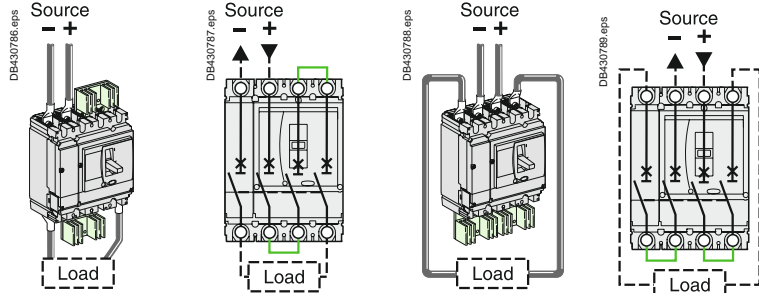

- All connections are possible for the fixed and withdrawable versions.
- Indifferent connection of polarities, from left to right or right to left.
- Indifferent connection of upstream and downstream cables to top or bottom terminals.
- Series connection of poles is possible by upstream/downstream connections. Creation of the connections is the responsibility of the panel builder or the installer.

Great flexibility for connections

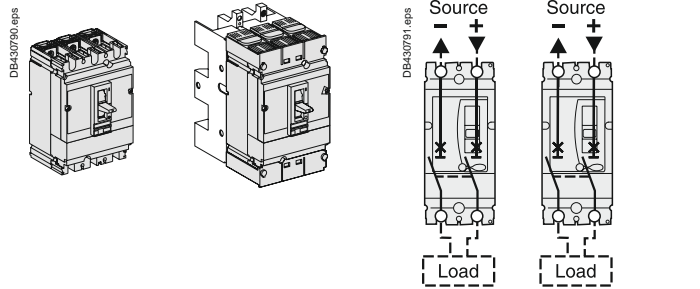

All connections are possible for the fixed and withdrawable versions.

Indifferent connection of polarities.

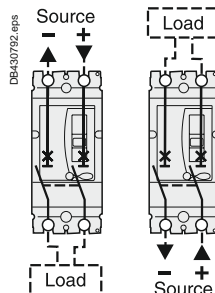

Upstream/downstream connections to top or bottom connectors.

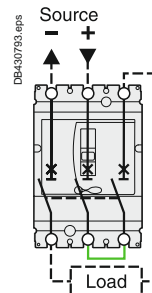

Series connection of poles is possible by upstream/downstream connections (user made).

Great flexibility in adapting to DC applications

Overview of series connection of poles for Compact INS/INV

With Compact INS/INV switch-disconnectors, it is easy to create a large number of series pole arrangements using prefabricated connections mounted on site during equipment installation.

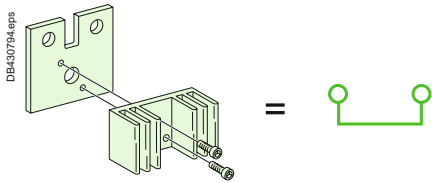

One type of connection per frame size, two catalogue numbers for all series connections.

Series connection of poles for direct current applications

Examples of series connection

Three-pole devices

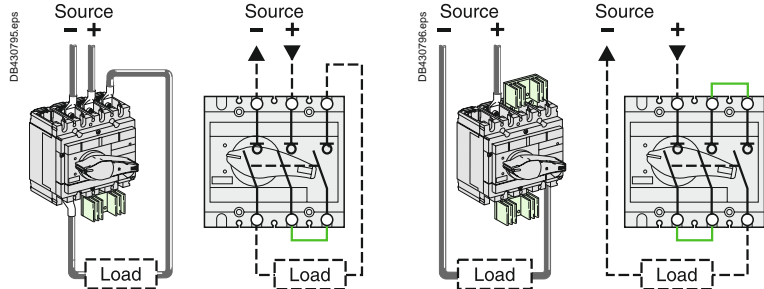

Four-pole devices

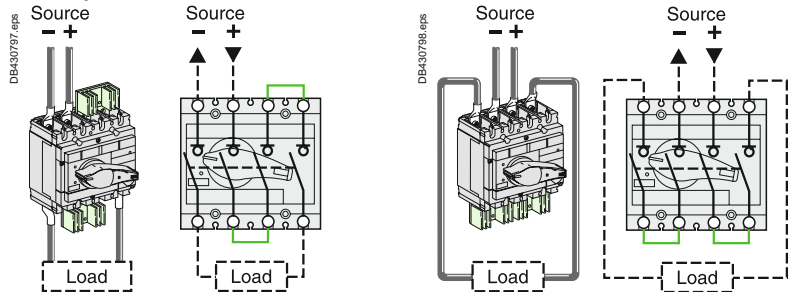

- Indifferent connection of polarities, from left to right or right to left.
- Indifferent connection of upstream and downstream cables to top or bottom terminals.
- Series connection of poles is possible by upstream/downstream connections. Creation of the connections is the responsibility of the panel builder or the installer.

Great flexibility for connections

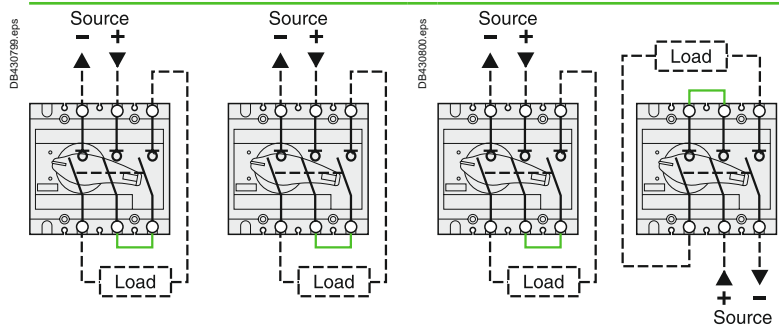

Indifferent connection of polarities.

Upstream/downstream connections to top or bottom connectors.

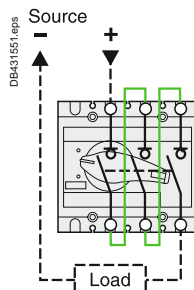

Series connection of poles is possible by upstream/downstream connections (user made).

Great flexibility in adapting to DC applications

Overview of series connection of poles for Masterpact NW DC

Masterpact NW DC circuit breakers, with high ratings and installed as incoming devices, offer three coupling versions C, D and E ready for connection. The polarities "Line -", "Line +" indicated on the rear connections of the Masterpact NW DC circuit breakers have to be respected in order to ensure the magnetic threshold tolerances.

Masterpact NW DC

Three versions supplied ready for connection

Version C

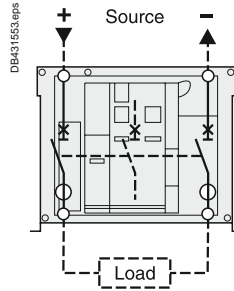

Front view: three-pole case - two poles in series.

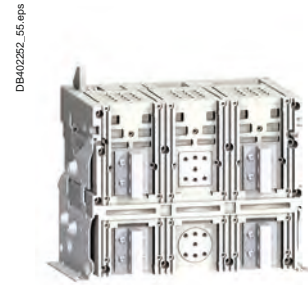

Rear view.

The safe prefabricated series connections are factory made due to the power ratings. They also dissipate heat.

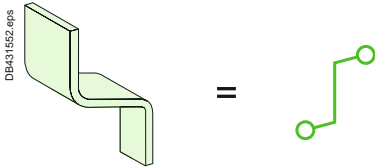

Version D

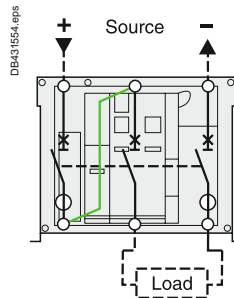

Front view: three-pole case - three poles in series.

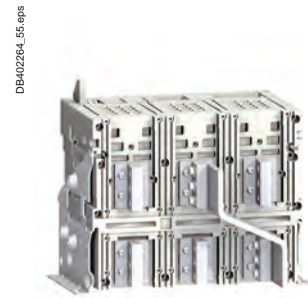

Rear view with connections.

Version E

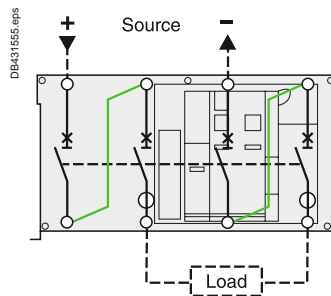

Front view: four-pole case - four poles in series.



Rear view with connections.

Great flexibility in adapting to DC applications

Parallel connection of poles

The exceptional performance levels of Compact NSX DC and DC PV circuit breakers mean the poles can be parallel connected. This technique virtually doubles, triples or quadruples the current rating depending on the type of circuit breaker and thus reduces the cost of solutions.

Examples of parallel connection

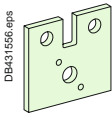

Parallel pole connection accessories are identical to those for series connections. They are equipped with heat sinks. Customer connections are made directly to the connection plates after removing the heat sinks.

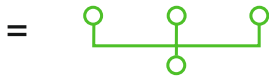
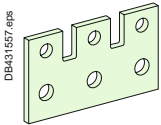

Specific connections are required for parallel connection of three poles.

Two-pole devices

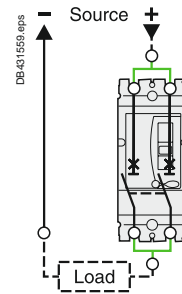
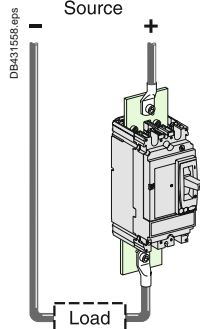

Three-pole devices

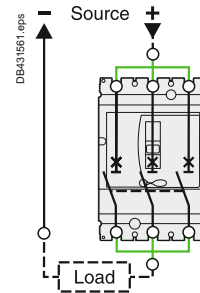
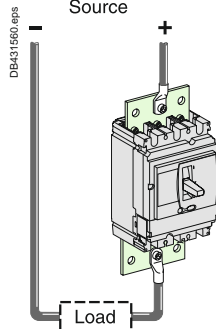

Four-pole devices (2 x 2 poles in parallel)

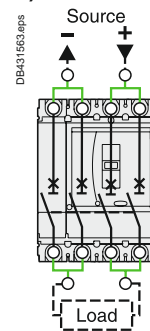
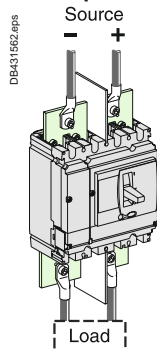

It is possible to mix series and parallel connections

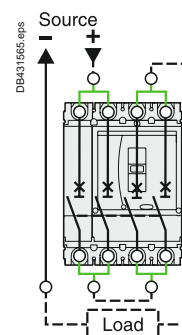
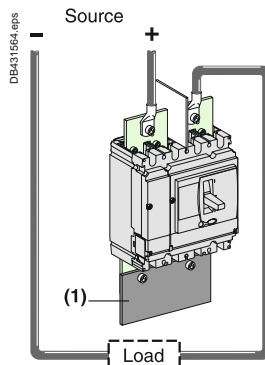

Note: creation of the additional connection [1] is the responsibility of the panel builder or the installer.

Presentation

Great flexibility in adapting to DC PV applications Overview of series connectors for NSX DC PV

Compact NSX TM DC PV

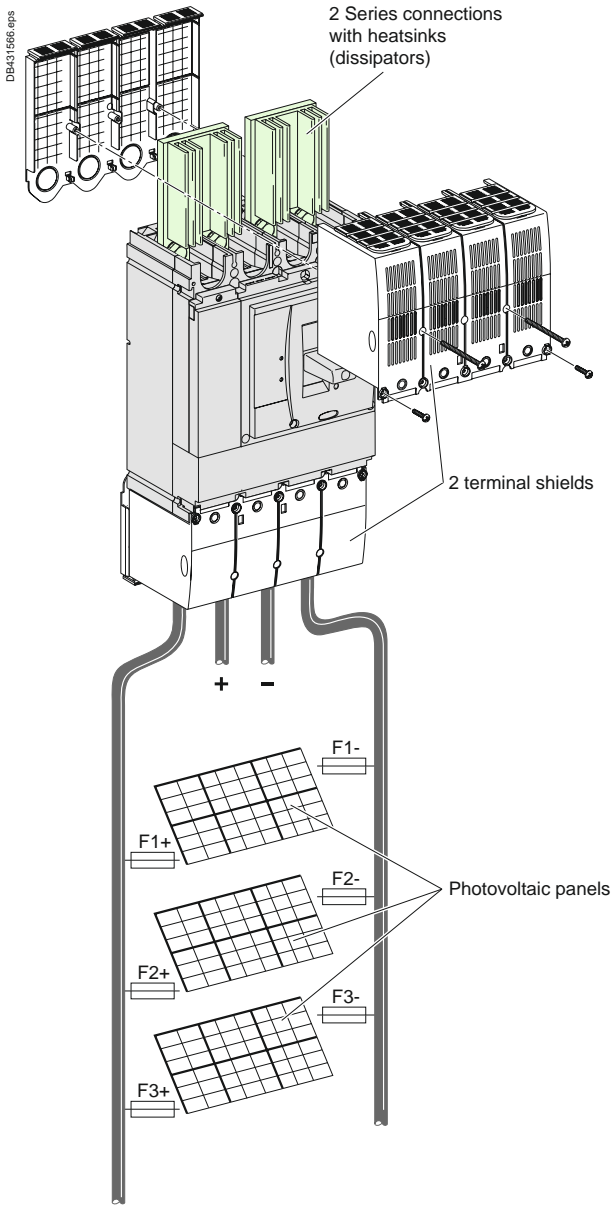

Compact NSX NA DC PV

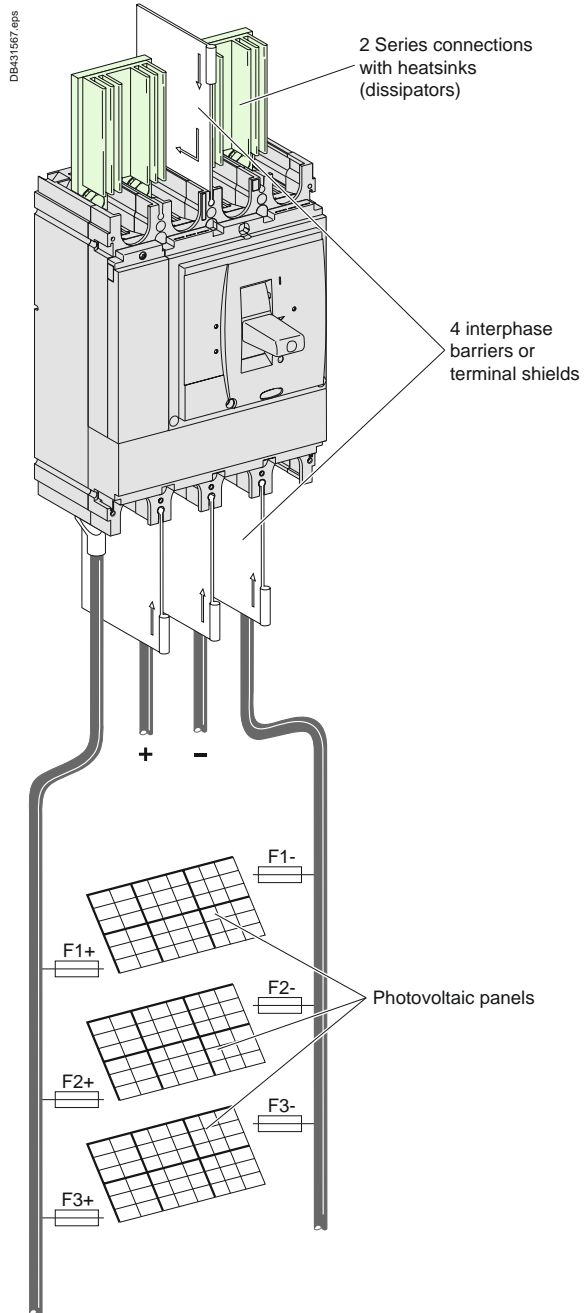

Connection accessories

The exceptional performance levels of Compact INS/INV switch-disconnectors mean the poles can be parallel connected. This technique virtually doubles, triples or quadruples the current rating depending on the type of circuit breaker and thus reduces the cost of solutions.

Parallel connection of poles for direct current applications

Examples of parallel connection

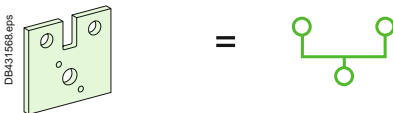

Parallel pole connection accessories are identical to those for series connections. They are equipped with heat sinks.

Customer connections are made directly to the connection plates after removing the heat sinks.



Specific connections are required for parallel connection of three poles.

Three-pole devices

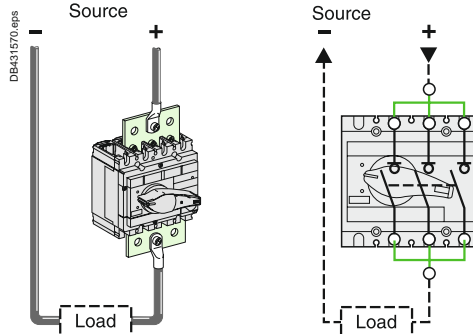

Four-pole devices (2 x 2 poles in parallel)

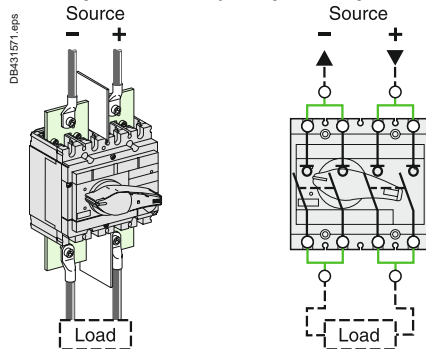

It is possible to mix series and parallel connections

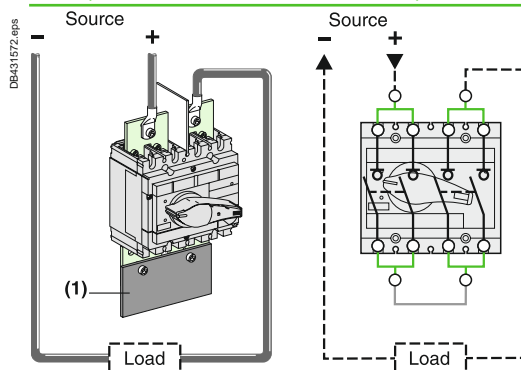

Note: creation of the additional connection [1] is the responsibility of the panel builder or the installer.

Great flexibility for connections

- Indifferent connection of polarities, from left to right or right to left.
- Indifferent connection of upstream and downstream cables to top or bottom terminals.



Functions and characteristics

Selection guide for DC circuit breakers	
Types of DC distribution systems.....	A-4
Solutions depending on the distribution system and the voltage... ..	A-5
Examples of circuit breaker selection	A-8
Connection accessories	A-9
Selection guide for DC circuit breakers	
Examples of circuit breaker selection	A-10
Calculation of DC distribution-system characteristics	
Short-circuit currents L/R time constant.....	A-11
General characteristics of Compact NSX DC and DC PV	
Operating conditions	A-12
Compact NSX DC and DC PV.....	A-13
Circuit breaker characteristics	
Compact NSX100 DC to NSX250 DC	A-14
Compact NSX400 DC to NSX1200 DC	A-16
Trip-unit characteristics	
Types of trip units - Trip units for Compact NSX DC	A-18
Characteristics and performance of Compact NSX switch-disconnectors from 100 to 250 NA	A-20
Switch-disconnectors characteristics	
Compact NSX400/630 NA DC	A-22
Accessories and auxiliaries	
Overview of Compact NSX100 to 630 DC fixed version	A-24
Overview of Compact NSX1200 DC fixed version	A-26
Overview of Compact NSX100 to 630 DC plug-in and withdrawable versions	A-28
Electrical and mechanical accessories	
Compact NSX100 to 1200 DC.....	A-30
Connection of fixed devices.....	A-32
Connection of electrical auxiliaries.....	A-34
Selection of auxiliaries for Compact NSX100/160/250 DC.....	A-36
Selection of auxiliaries for Compact NSX400/630/1200 DC.....	A-38
Indication contacts for Compact NSX DC.....	A-39
Rotary handles for Compact NSX DC.....	A-40
Motor mechanism for Compact NSX DC	A-42
Remote tripping for Compact NSX DC	A-43
Locks for Compact NSX DC	A-44
Sealing accessories for Compact NSX DC.....	A-45
Escutcheons and protection collars for Compact NSX DC	A-46

Functions and characteristics

Source-changeover systems

Presentation	A-48
Manual source-changeover systems	A-49

Circuit breaker characteristics

Compact NSX80 TM DC PV to NSX500 TM DC PV	A-50
---	------

Switch-disconnectors characteristics

Compact NSX100 NA DC PV to NSX500 NA DC PV	A-52
Compact NSX630b NA DC PV to NSX1600 NA DC PV	A-54

Accessories and auxiliaries

Overview of Compact NSX80 TM to NSX500 TM DC PV circuit breakers	A-56
Overview of Compact NSX100 NA to NSX500 NA DC PV switch-disconnectors	A-57
Overview of Compact NSX630b NA to NSX1600 NA DC PV switch-disconnectors	A-58

Compact INS DC PV

A-59

Switch-disconnector selection

Compact INS40 to 160 DC	A-60
Compact INS250-100 to 630 DC	A-64
Compact INS630b to 2500 DC	A-68
Compact INV100 to 630 DC	A-72
Compact INV630b to 2500 DC	A-76

Communication

Enerlin'X communication system - Products overview	A-80
IFE Ethernet interface	A-82
IFM Modbus communication interface	A-84
COM option in Compact and Masterpact	A-85
I/O application module	A-86
Communications modules, IFM and IFE for Compact NSX	A-88
Communication components and connections	A-89
Connection of the IFE to a fixed or drawout Masterpact NW	A-90
Connection of the IFM to a fixed or drawout Masterpact NW	A-91
Electrical Asset Manager Configuration Engineering tool	A-92

A

Functions and characteristics

General characteristics of Masterpact NW DC - DC PV	
Operating conditions	A-94
Masterpact NW10 to NW40 DC	A-96
Trip-unit characteristics..... A-98	
Trip units for Masterpact NW DC	A-98
Switch-disconnectors for PV application	
Masterpact NW HADCD-PV	A-100
Connections and safety clearances	A-101
Panorama of electrical and mechanical accessories	
Masterpact NW10 to NW40 DC	A-102
Connection	
Overview of solutions	A-104
Electrical and mechanical accessories	
Masterpact NW10 to NW40 DC	A-106



Selection guide for DC circuit breakers

Types of DC distribution systems

There are three types of DC distribution systems (see the table).
The operational voltage in conjunction with one of the three systems determines the number of poles taking part in current interruption.

Selection of a circuit breaker depends essentially on the distribution-system parameters presented below which are used to determine the corresponding characteristics:

- type of system - determines the type of product and the number of poles connected in series for each polarity
- rated voltage - determines the number of series poles taking part in current interruption
- nominal current - determines the rated current of the Circuit breaker
- maximum short-circuit current at the point of installation - determines the breaking capacity.

Types of systems			
Earthed systems	Isolated systems		
The source has one earthed polarity ⁽¹⁾	The source has an earthed mid-point		
Diagrams and different faults			
Fault analysis (neglecting resistance of earth electrodes)			
Fault A	<ul style="list-style-type: none"> ■ maximum I_{sc} at U ■ only protected polarity concerned ■ all poles of protected polarity must have breaking capacity ≥ I_{sc} max. at U 	<ul style="list-style-type: none"> ■ maximum I_{sc} at U/2 ■ only positive polarity concerned ■ all poles of positive polarity must have breaking capacity ≥ I_{sc} max. at U/2 	<ul style="list-style-type: none"> ■ no consequences ■ the fault must be indicated by an IMD (insulation-monitoring device) and cleared (standard IEC/EN 60364)
Fault B	<ul style="list-style-type: none"> ■ maximum I_{sc} at U ■ if only one polarity (the positive here) is protected, all poles of protected polarity must have breaking capacity ≥ I_{sc} max. at U ■ if both polarities are protected, to enable disconnection, all poles of the two polarities must have breaking capacity ≥ I_{sc} max. at U 	<ul style="list-style-type: none"> ■ maximum I_{sc} at U ■ both polarities are concerned ■ all poles of the two polarities must have breaking capacity ≥ I_{sc} max. at U 	<ul style="list-style-type: none"> ■ maximum I_{sc} at U ■ both polarities are concerned ■ all poles of the two polarities must have breaking capacity ≥ I_{sc} max. at U
Fault C	No consequences	<ul style="list-style-type: none"> ■ same as fault A ■ all poles of the negative polarity must have breaking capacity ≥ I_{sc} max. at U/2 	<ul style="list-style-type: none"> ■ same as fault A with the same obligations
Double fault A and D or C and E	Double fault not possible, system trips on first fault	Double fault not possible, system trips on first fault	<ul style="list-style-type: none"> ■ maximum I_{sc} at U ■ only positive polarity (cases A and D) or negative (C and E) concerned ■ all poles of each polarity must have breaking capacity ≥ I_{sc} max. at U
Most unfavourable cases			
Fault A and fault B (if only one polarity is protected)	Fault B	Double fault A and D or C and E	
Conclusion: selection of number of poles and breaking capacity			
Layout of protection poles			
<ul style="list-style-type: none"> ■ on only one polarity^[1] 	<ul style="list-style-type: none"> ■ identical for each polarity 	<ul style="list-style-type: none"> ■ identical for each polarity 	
Number of series poles			
Per polarity	<ul style="list-style-type: none"> ■ all on same polarity 	<ul style="list-style-type: none"> ■ equal 	<ul style="list-style-type: none"> ■ equal
Total	<ul style="list-style-type: none"> ■ 1, 2 or 3 without disconnection ■ 2, 3 or 4 with disconnection 	<ul style="list-style-type: none"> ■ 2 or 4^[2] 	<ul style="list-style-type: none"> ■ 2 or 4^[2]
Breaking capacity			
<ul style="list-style-type: none"> ■ all poles of the protected polarity ≥ I_{sc} max. at U 	<ul style="list-style-type: none"> ■ all poles of both polarities ≥ I_{sc} max. at U ■ all poles of each polarity ≥ I_{sc} max. at U/2 	<ul style="list-style-type: none"> ■ all poles of each polarity ≥ I_{sc} max. at U 	
Disconnection of both polarities^[3]			
Possible by adding a pole to the non-protected polarity	<ul style="list-style-type: none"> ■ ensured 	<ul style="list-style-type: none"> ■ ensured 	
Implementation			
See the selection table opposite			

[1] Positive or negative, depending on the polarity connected to the exposed conductive parts.

[2] A 3P circuit breaker can be used if a 2P version does not exist. In this case, the central pole is not connected.

[3] Disconnection made possible by multi-pole breaking.

Selection guide for DC circuit breakers

Solutions depending on the distribution system and the voltage

Series connection of poles

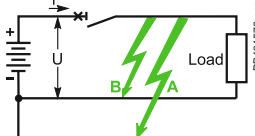
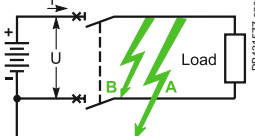
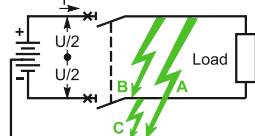
Type of distribution system			
Type	Earthed		Isolated
Source	One polarity (negative here) connected to earth (or exposed conductive parts)		Isolated polarities
Protected polarities	1 (disconnection of 1P)	2 (disconnection of 2P)	2
Diagrams (and types of faults)			

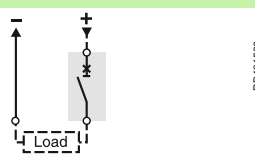
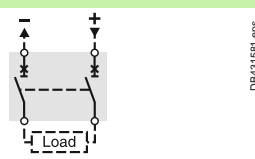
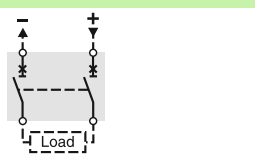
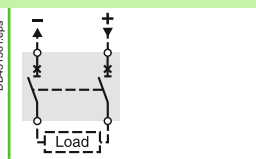
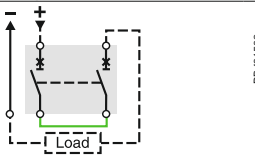
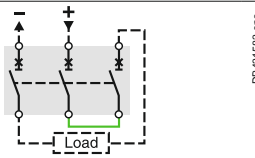
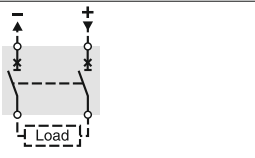
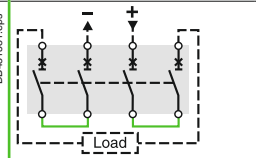
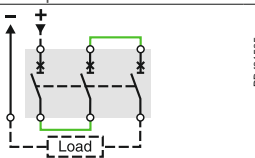
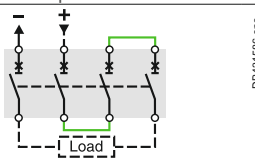
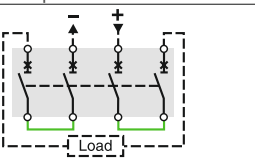
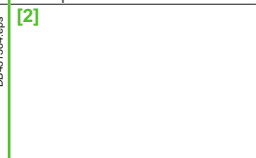
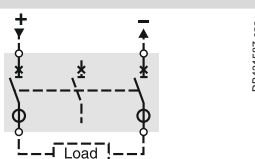
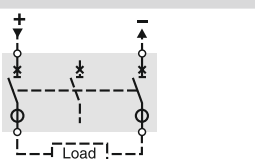
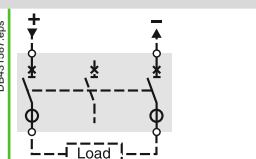
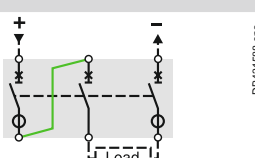
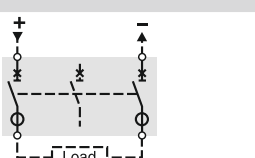
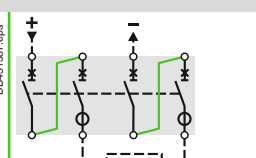
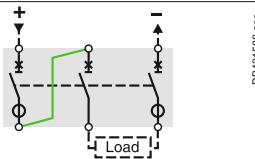
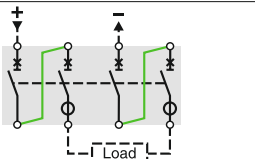
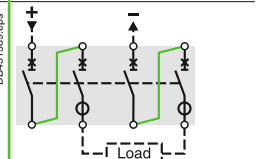
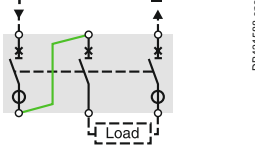
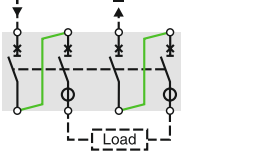
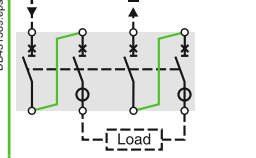

Selection of circuit breaker and pole connection

Compact NSX DC				
24 V ≤ Un ≤ 250 V	 Single-pole.	 Two-pole ^[1] .	 Two-pole ^[1] .	 Two-pole ^[1] .
NSX100-600 250 V < Un ≤ 500 V	 Two-pole ^[1] .	 Three-pole.	 Two-pole ^[1] .	 Four-pole.
NSX100-500 500 V < Un ≤ 750 V	 Three-pole.	 Four-pole.	 Four-pole.	 Four-pole ^[2] .
Masterpact NW DC				
Type N				
24 V ≤ Un ≤ 500 V		 Version C.	 Version C.	 Version C.
Type H				
24 V ≤ Un ≤ 500 V		 Version D.	 Version C.	 Version E.
500 V < Un ≤ 750 V		 Version D.	 Version E.	 Version E.
750 V < Un ≤ 900 V		 Version D.	 Version E.	 Version E.

[1] A 3P circuit breaker can be used if a 2P version does not exist. In this case, the central pole is not connected.

[2] Compact NSX DC circuit breakers (and switch disconnectors) are designed to break the rated current or fault current at the rated operational voltage (Ue) with all poles. To break the current at voltage > 500 V, three poles in series are required. In double earth fault situations (A + D or C + E), the circuit breaker (and Switch disconnectors) must break the current at full voltage with only half of the poles. Compact NSX DC circuit breakers (and Switch disconnectors) are not designed for this purpose and could sustain irremediable damage if used to break the current in a double earth fault situation for voltage > 500 V.

Selection guide for DC circuit breakers

Solutions depending on the distribution system and the voltage

Parallel connection of poles

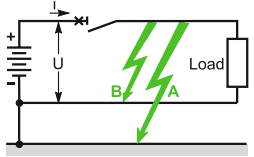
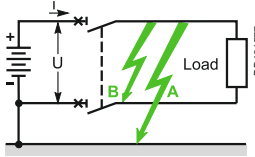
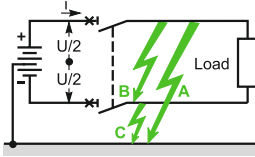
Type of distribution system			
Type	Earthed		Isolated
Source	One polarity (negative here) connected to earth (or exposed conductive parts)		Mid-point connected to earth
Protected polarities	1 (disconnection of 1P)	2 (disconnection of 2P)	2
Diagrams (and types of faults)			

Selection of circuit breaker and pole connection

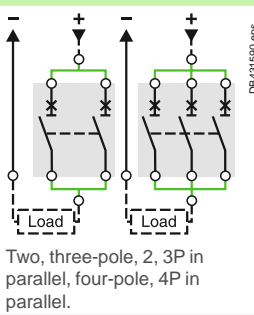
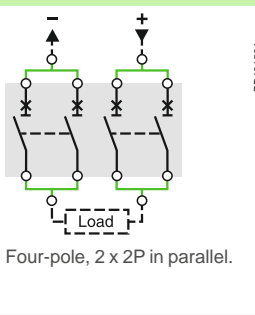
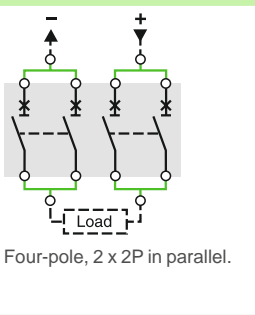
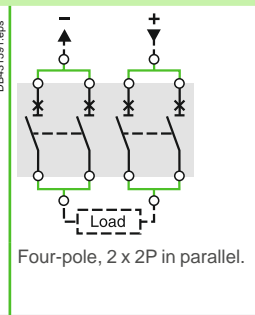
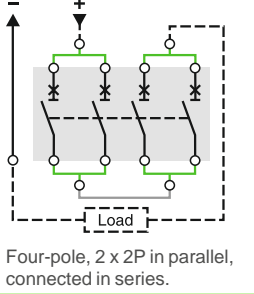
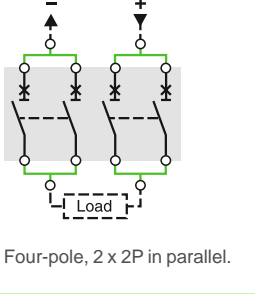
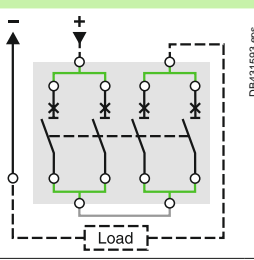
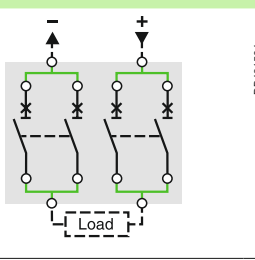
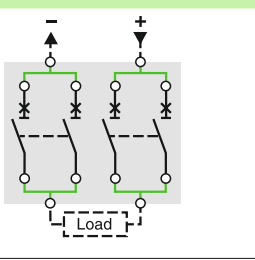
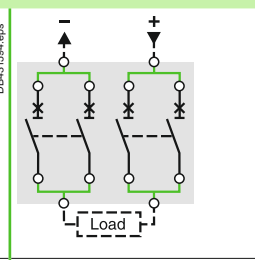
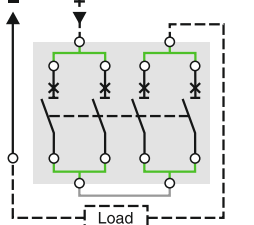
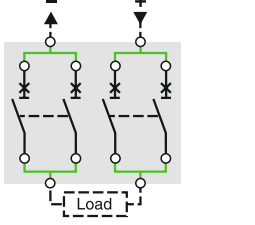
Compact NSX DC				
$U_n \leq 250$ V				
250 V < $U_n \leq 500$ V				(1)
$U_n \leq 300$ V				
300 V < $U_n \leq 600$ V				(3)

(1) Compact NSX DC circuit breakers (and switch disconnectors) are designed to break the rated current or fault current at the rated operational voltage (U_e) with all poles. To break the current at voltage > 250 V, two poles in series are required. In double earth fault situations (A + D or C + E), the circuit breaker (and switch disconnectors) must break the current at full voltage with only half of the poles. Compact NSX DC circuit breakers (and switch disconnectors) are not designed for this purpose and could sustain irremediable damage if used to break the current in a double earth fault situation for voltage > 250 V.

(2) Do not remove parallel connectors.

(3) Compact NSX DC circuit breakers (and switch disconnectors) are designed to break the rated current or fault current at the rated operational voltage (U_e) with all poles. To break the current at voltage > 300 V, two poles in series are required. In double earth fault situations (A + D or C + E), the circuit breaker (and switch disconnectors) must break the current at full voltage with only half of the poles. Compact NSX DC circuit breakers (and switch disconnectors) are not designed for this purpose and could sustain irremediable damage if used to break the current in a double earth fault situation for voltage > 300 V.

Selection guide for DC circuit breakers

Solutions depending on the distribution system and the voltage

Comparison of series and parallel connection in terms of performance

Series connection of poles on a DC circuit breaker is the means to:

- divide the system voltage by the number of poles
- use the rated current for each pole
- use the breaking capacity of the circuit breaker for all the poles.

For example, a Compact NSX630, 3P DC type, with the three poles connected in series, provides:

- a maximum voltage of 750 V (250 V per pole)
- a rated current of 630 A
- a breaking capacity of 100 kA / 750 V.

Consequently, a 630 A / 250 V device can be used in a 750 V system.

Parallel connection of poles, on the contrary, imposes the system voltage on each pole, but is the means to:

- divide the current flowing through each pole by the number of poles
- increase the rated current.

For example, the same Compact NSX630 DC 3P circuit breaker with three poles in parallel provides:

- a maximum voltage of 250 V (250 V per pole)
- a rated current of 1500 A (see table page B-9).

Consequently, a 630 A device used in a 250 V system can handle 1500 A.

Series connection of poles divides the voltage per pole and optimises breaking capacity for high-voltage systems.

Parallel connection of poles divides the current per pole and optimises the rated current for systems that do not exceed the withstand voltage of each pole.

The maximum useable rating and the value of the magnetic setting are indicated (see pages B-7, B-8 and B-9).

A

Selection guide for DC circuit breakers

Examples of circuit breaker selection

A

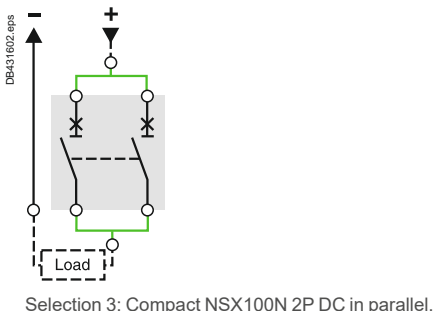
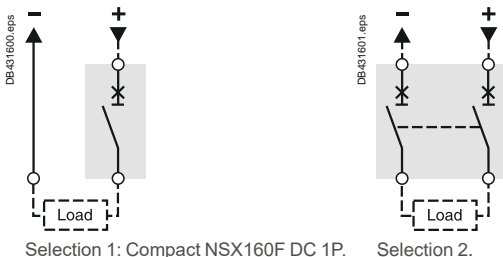
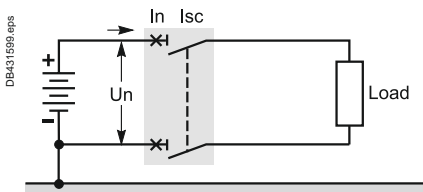
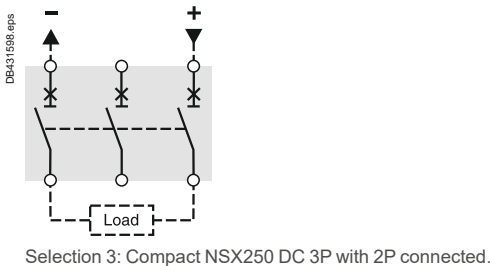
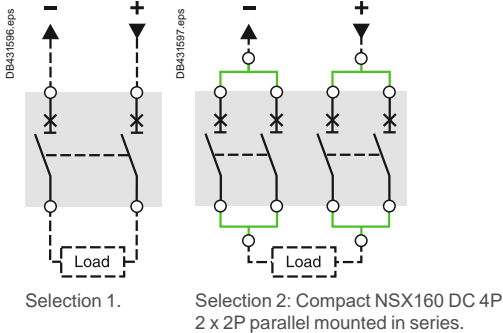
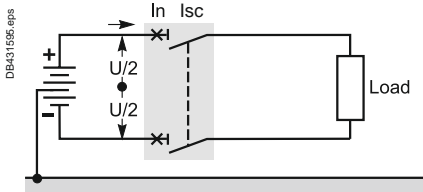

Selection of a Compact NSX DC

Example 1

- Type of system - mid-point connected to earth
- System voltage - $U_n = 500 \text{ V DC}$ with time constant $L/R = 5 \text{ ms}$
- Rated current required at point of installation $I_n = 250 \text{ A}$
- Short-circuit current at the point of installation $I_{sc} = 20 \text{ kA}$

Selection constraints - (see page A-4)

The system with the mid-point connected to earth requires (see conclusion page A-4):

- identical protection-pole layout for each polarity
- an equal number of poles for each polarity, i.e. a total of two or four
- all poles of the two polarities must have breaking capacity $\geq I_{sc} \text{ max. at } U_n$, i.e. $20 \text{ kA}/500 \text{ V}$ in this case
- all poles of the each polarity must have breaking capacity $\geq I_{sc} \text{ max. at } U_n/2$, i.e. $20 \text{ kA}/250 \text{ V}$ in this case.

Selection possibilities - (see pages A-5 and A-6)

The tables indicate for $250 \text{ V} < U_n \leq 500 \text{ V}$ and for this system:

- poles connected in series: two-pole 2P in series → **selection 1**
- poles connected in parallel: four-pole 2 x 2P parallel connected in series → **selection 2**.

Circuit breaker selection - (see pages A-14 and B-8)

- **selection 1**: the 250 A rated current does not exist in 2P. It is possible to use a 250 A 3P DC type circuit breaker with the central pole not connected → **selection 3**
- **selection 2**: the 160 A rated current (DC version) is suitable with a 2 x 2P assembly connected in parallel because (see table page B-8):
 - the rated current of the 2 x 2P assembly connected in parallel is $I_n = 288 \text{ A} > 250 \text{ A}$
 - and for $L/R = 5 \text{ ms}$:
 - breaking capacity of all poles = $36 \text{ kA}/500 \text{ V} > 20 \text{ kA}/500 \text{ V}$
 - breaking capacity of poles of each polarity = $36 \text{ kA}/250 \text{ V} > 20 \text{ kA}/250 \text{ V}$.

The options are:

- **selection 1**: Compact NSX250S DC, 3P, 2 poles connected
 - **selection 3**: Compact NSX160 DC, 4P, 2 x 2P parallel connected in series.
- Both solutions exist in fixed and withdrawable configurations.

Trip-unit selection

- Compact NSX250 DC 3P: the selection table (see page A-18) indicates 3 TM250DC trip units, which are interchangeable
- Compact NSX160 DC, 4P (2 x 2P) 160 A: the selection table (see page B-8) indicates, for the 2 x 2P parallel configuration mounted in series and for 250 A, a TM125DC trip unit with the magnetic-protection threshold set to 2500 A.

Example 2

- Type of system - one polarity earthed
- System voltage - $U_n = 250 \text{ V DC}$ with time constant $L/R = 5 \text{ ms}$
- Rated current required at point of installation $I_n = 160 \text{ A}$
- Short-circuit current at the point of installation $I_{sc} = 20 \text{ kA}$.

Selection constraints - (see page A-4)

The system with one polarity connected to earth requires (see conclusion page A-4):

- protection poles on the protected polarity
- all poles contribute to breaking for the polarity:
 - 1, 2 or 3P without disconnection of the two polarities
 - 2, 3 or 4P with disconnection of the two polarities
- all poles of the protected polarity must have breaking capacity $\geq I_{sc} \text{ max. at } U_n$, i.e. $20 \text{ kA}/250 \text{ V}$ in this case.

Selection possibilities - (see pages A-5 and A-6)

The tables indicate for $U_n \leq 250 \text{ V}$ and for this system:

- poles connected in series: single-pole → **selection 1** (or two-pole with disconnection → **selection 2**)
- poles connected in parallel: two-pole → **selection 3**
- other selections (parallel connection) are possible, but are of no particular interest.

Circuit breaker selection - (see pages A-14 and B-7)

- **selection 1**: Compact NSX160F DC, 1P, 36 kA, available in fixed version (or **selection 2**: Compact NSX160F DC, 2P, 36 kA, if disconnection of the two polarities is desired)
- **selection 3**: Compact NSX100N DC, 2P in parallel, 36 kA, providing a rated current of 200 A (see table page B-7), available in fixed version.

Trip-unit selection

- Compact NSX160N DC, 1P: the selection table (see page A-18) indicates a built-in TM160DC trip unit with the magnetic-protection threshold set to 1250 A
- Compact NSX100N DC, 2P in parallel: the selection table (see page B-7) indicates, for the 2P parallel configuration and for 160 A, a TM80D trip unit with the magnetic-protection threshold set to 1600 A.

Solutions depending on the distribution system and the voltage

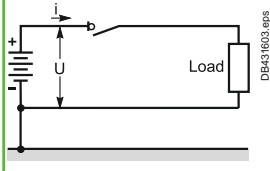
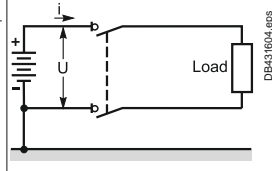
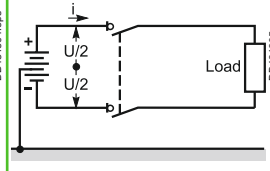
Type of distribution system			
Type	Earthed		Isolated
Source	One polarity (negative here) connected to earth (or exposed conductive parts)		Mid-point connected to earth
Protected polarities	1 (disconnection of 1P)	2 (disconnection of 2P)	2
Diagrams, connection method			

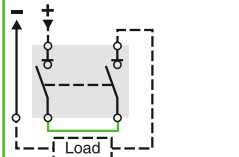
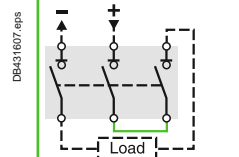
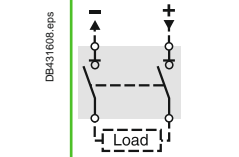
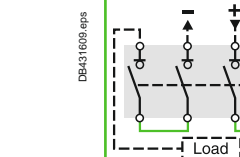
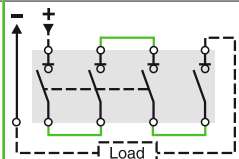
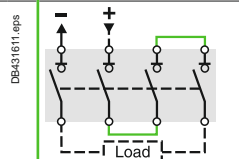
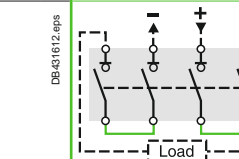

Series connection of poles

Selection of switch-disconnectors and pole connection				
Compact INS/INV				
24 V ≤ Un ≤ 125 V	 Two-pole⁽¹⁾.	 Three-pole.	 Two-pole⁽¹⁾.	 Four-pole.
125 V < Un ≤ 250 V	 Four-pole.	 Four-pole.	 Four-pole.	Not applicable

(1) A 3P switch-disconnectors can be used if a 2P version does not exist. In this case, the central pole is not connected.

Parallel connection of poles

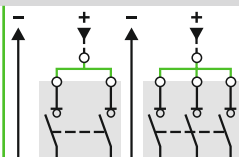
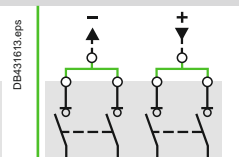
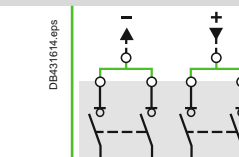
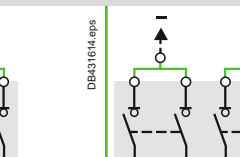
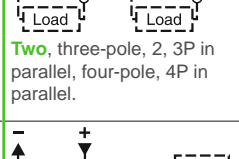
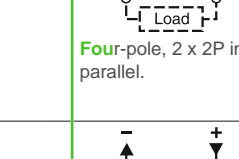
Selection of switch-disconnectors and pole connection				
Compact INS/INV				
Un ≤ 63 V	 Two, three-pole, 2, 3P in parallel, four-pole, 4P in parallel.	 Four-pole, 2 x 2P in parallel.	 Four-pole, 2 x 2P in parallel.	 Four-pole, 2 x 2P in parallel.
63 V < Un ≤ 125 V	 Four-pole, 2 x 2P in parallel, connected in series.	Not applicable	 Four-pole, 2 x 2P in parallel.	Not applicable

Selection guide for DC circuit breakers

Examples of circuit breaker selection

A

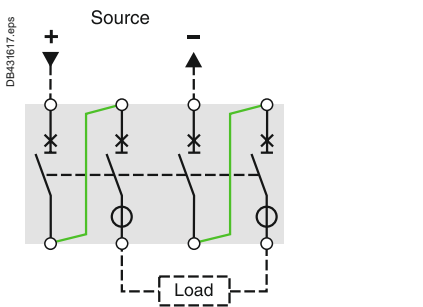
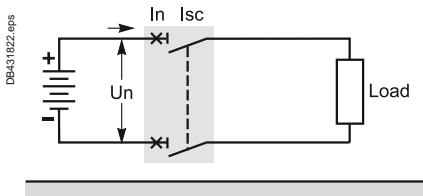

Masterpact NW20H DC version E.

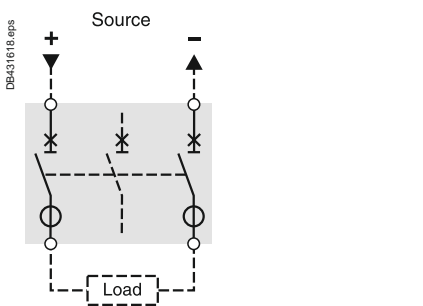
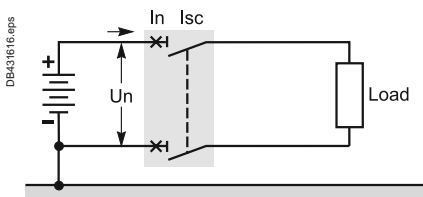

Masterpact NW10N DC version C.

Selection of a Masterpact NW DC

Example 1

- Type of system - isolated polarities
- System voltage - $U_n = 750 \text{ V DC}$ with time constant $L/R = 30 \text{ ms}$
- Rated current required at point of installation $I_n = 2000 \text{ A}$
- Short-circuit current at the point of installation $I_{sc} = 40 \text{ kA}$

Selection constraints - (see page A-4)

The system with isolated polarities requires (see conclusion page A-4):

- identical protection for each polarity
- an equal number of poles for each polarity, i.e. a total of two or four
- all poles of each polarity must have breaking capacity $\geq I_{sc \text{ max. at } U_n}$, i.e. $40 \text{ kA}/750 \text{ V}$ in this case.

Selection possibilities - (see page A-5)

The table for series poles indicates for a voltage $24 \text{ V} < U_n \leq 750 \text{ V}$ and the type of system, use of a four-pole, version E circuit breaker.

Circuit breaker selection - (see page A-96)

The Masterpact NW DC characteristics table indicates more specifically with a 2000 A a NW20 DC type H circuit breaker with a breaking capacity of $50 \text{ kA}/750 \text{ V}$ ($L/R = 30 \text{ ms}$).

The correct selection is a Masterpact NW20 DC type H version E, 2000 A , 50 kA , available in fixed and drawout versions.

Example 2

- Type of system - one polarity earthed
- System voltage - $U_n = 500 \text{ V DC}$ with time constant $L/R = 15 \text{ ms}$
- Rated current required at point of installation $I_n = 1000 \text{ A}$
- Short-circuit current at the point of installation $I_{sc} = 30 \text{ kA}$

Selection constraints - (see page A-4)

The system with one polarity connected to earth requires (see conclusion page A-4):

- protection poles on the protected polarity
- all poles contribute to breaking for the polarity:
 - 1, 2 or 3P without disconnection of the two polarities
 - 2, 3 or 4P with disconnection of the two polarities
- all poles of the protected polarity must have breaking capacity $\geq I_{sc \text{ max. at } U_n}$, i.e. $30 \text{ kA}/500 \text{ V}$ in this case.

Selection possibilities - (see page A-5)

The table for series poles indicates for a voltage $24 \text{ V} < U_n \leq 500 \text{ V}$ and the type of system, use of a three-pole, version C circuit breaker.

Circuit breaker selection - (see page A-96)

The Masterpact NW DC characteristics table indicates more specifically with a 1000 A a NW10 DC type N circuit breaker with a breaking capacity of $35 \text{ kA}/500 \text{ V}$ ($L/R = 15 \text{ ms}$). The correct selection is a Masterpact NW10 DC type N version C, 1000 A , 35 kA , available in fixed and drawout versions.

Calculation of DC distribution-system characteristics

Short-circuit currents L/R time constant

Short-circuit currents

Calculation of the short-circuit current across the terminals of a battery

During a short-circuit, the battery discharges a current equal to :

$$I_{sc} = \frac{V_b}{R_i}$$

- V_b = maximum discharge voltage (battery 100 % charged)
- R_i = internal resistance equivalent to all cells (a function of the capacity in ampere-hours).

Example

- Consider a set of four 500 Ah batteries connected in parallel.
- Discharge voltage of one battery: 240 V (110 cells 2.2 V each).
- Discharge current of one battery: 300 A with a run-time of 30 minutes.
- Discharge current of all four batteries: 1200 A with a run-time of 30 minutes.
- Internal resistance 0.5 mΩ per cell, i.e. for one battery: $R_i = 110 \times 0.5 \times 10^{-3} = 55 \times 10^{-3} \Omega$.
- Short-circuit current of one battery: $I_{sc} = 240 \text{ V} / 55 \times 10^{-3} \Omega = 4.37 \text{ kA}$.
- Neglecting the resistance of the connections, for all four batteries discharging the short-circuit current in parallel, the total short-circuit current is four times that of one battery, i.e. $I_{sc} = 4 \times 4.37 \text{ kA} = 17.5 \text{ kA}$.

Note: if the internal resistance is not known, it is possible to use the following rough approximation: $I_{sc} = kc$ where c is the capacity of the battery in ampere-hours and k is a coefficient close to 10 and always less than 20.

Other typical examples

- PABXs: I_{sc} from 5 to 25 kA at 240 V DC with $L/R = 5 \text{ ms}$.
- Submarine: I_{sc} from 40 to 60 kA at 400 V DC with $L/R = 5 \text{ ms}$.

L/R time constant

When a short-circuit occurs across the terminals of a DC circuit, the current rises from the load current ($\leq I_n$) to the short-circuit current I_{sc} over a period of time that depends on the value of the resistance R and inductance L of the short-circuited loop.

The equation determining the current in the loop is:

$$U = R_i + L \Delta i / \Delta t$$

The curve of I versus time is defined (neglecting I_n) by the equation:

$$I = I_{sc} (1 - \exp(-t/\tau))$$

where $\tau = L/R$ is the time constant for the rise to I_{sc} .

Practically speaking, after a time $t = 3\tau$, the short-circuit is considered to be established, because the value of $\exp(-3) = 0.05$ is negligible compared to 1 (see the curve opposite).

The lower the time constant (e.g. battery circuit), the shorter the time required for the current to rise to I_{sc} .

To express breaking capacity, the interrupted short-circuit current with the following time constants is used:

- $L/R = 5 \text{ ms}$, fast short-circuit
- $L/R = 15 \text{ ms}$, standardised value used in standard IEC 60947-2
- $L/R = 30 \text{ ms}$, slow short-circuit.

In general, the value of the system time constant is calculated under worst-case conditions, across the terminals of the generator.

Breaking-capacity values for:

- Compact NSX DC (table page A-14) are the same for 5 ms and 15 ms
- Masterpact NW DC (table page A-96) are indicated for 3 values, 5 ms, 15 ms and 30 ms.

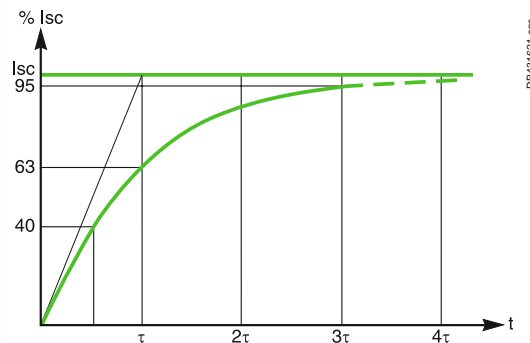
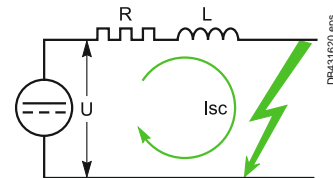
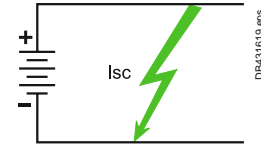

General characteristics of Compact NSX DC and DC PV

Operating conditions

A

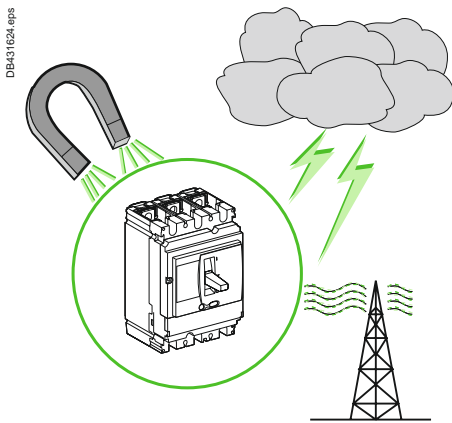
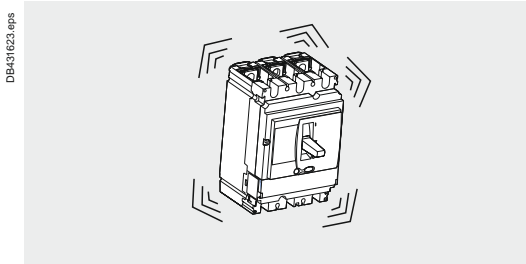
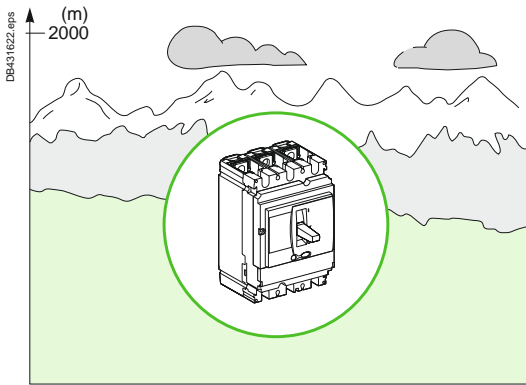

Altitude

Compact NSX circuit breakers are designed to operate at their rated values at altitudes under 2000 metres.

Above 2000 metres, the changes in the characteristics of the ambient air (electrical resistance, cooling capacity) result in a reduction of the characteristics below.

Altitude (m)	2000	3000	4000	5000
Compact NSX DC				
Impulse withstand voltage U_{imp} (kV)	8	7.1	6.4	5.6
Rated insulation voltage (U_i)	750	710	635	560
Maximum rated operational DC voltage	1 x U_e	0.88 x U_e	0.8 x U_e	0.7 x U_e
Rated current (A)	1 x I_n	0.96 x I_n	0.93 x I_n	0.9 x I_n
Compact NSX DC PV				
Impulse withstand voltage U_{imp} (kV)	8	7.1	6.4	5.6
Rated insulation voltage (U_i)	1000	900	800	700
Maximum rated operational DC voltage	1000	900	800	700
Rated current (A)	1 x I_n	0.96 x I_n	0.93 x I_n	0.9 x I_n

Vibrations

Compact NSX circuit breakers are guaranteed against electromagnetic or mechanical vibrations.

Tests are carried out in compliance with standard IEC 68-2-6 for the levels required by merchant-marine inspection organisations (Veritas, Lloyd's, etc.):

- 2 to 13.2 Hz: amplitude ± 1 mm
- 13.2 to 100 Hz: constant acceleration 0.7 g.

Excessive vibration may cause tripping, breaks in connections or damage to mechanical parts.

Electromagnetic compatibility

Compact NSX circuit breakers are protected against:

- overvoltages caused by devices that generate electromagnetic disturbances
- overvoltages caused by atmospheric disturbances or by a distribution-system outage (e.g. failure of a lighting system) and devices emitting radio waves (radios, walkie-talkies, radar, etc.)
- electrostatic discharges produced by users. The circuit breakers have successfully passed the electromagnetic-compatibility tests (EMC) defined by international standard IEC 60947-2, appendix F.

The above tests guarantee that:

- no nuisance tripping occurs
- tripping times are respected.

Compact NSX circuit breakers comply with the following electromagnetic-compatibility standards:

- IEC/EN 61000-4-2 - electrostatic immunity discharge test, part 2 (circuit breakers)
- IEC/EN 61000-4-3 - electromagnetic-field immunity test
- IEC/EN 61000-4-4 - electrical fast transient/burst immunity test
- IEC/EN 61000-4-5 - surge immunity test
- IEC/EN 61000-4-6 - immunity to conducted disturbances, induced by radiofrequency fields
- CISPR 11 - radio-frequency conducted and radiated emission tests required for CE marking:
- EN 61000-6-2 - immunity standard for industrial environments
- EN 50081-1-2 - emissions in commercial and industrial environments.

Ambient temperature

Operating-temperature range

- Compact NSX circuit breakers and switches may be used between -25 °C and $+70$ °C.
- For temperatures higher than 40 °C (65 °C for circuit breakers used to protect motor feeders), devices must be derated as indicated in the documentation.
- Circuit breakers and switches should be put into service under the normal, ambient operating temperatures indicated above. Exceptionally, they may be put into service when the ambient temperature is between -35 °C and -25 °C.

Derating

Above 40 °C, it is necessary to take into account the derating values.

Storage-temperature range

- Compact NSX circuit breakers and switches may be stored in their original packing between -50 °C and $+85$ °C.

General characteristics of Compact NSX DC and DC PV

Compact NSX DC and DC PV



Installation in class II switchboards

All Compact NSX DC circuit breakers are class II front-face devices. They may be installed through the door of class II switchboards (as per standard IEC 60664) without downgrading switchboard insulation. Installation requires no special operations even when the circuit breaker is equipped with a rotary handle or a motor mechanism.

Degree of protection

Compact NSX DC circuit breakers offer the following protection characteristics depending on the installation conditions:

- IP: degree of protection (standard IEC 60529)
- IK: protection against external mechanical impacts (standard EN 50102).

Compact NSX DC

Bare circuit breaker with terminal shields

DB431625.eps 	With toggle	IP3X	IK07
DB431626.eps 	With direct rotary handle, standard or VDE	IP3X	IK07

Circuit breaker installed in a switchboard

DB431627.eps 	With toggle	IP40	IK07
DB431628.eps 	With direct rotary handle, standard or VDE	IP40	IK07
DB431629.eps 	CCM	IP43	IK07
DB431630.eps 	CNOMO	IP54	IK07
DB431629.eps 	With extended rotary handle	IP55	IK08
DB431630.eps 	With motor mechanism	IP40	IK07

Positive contact indication

Compact NSX DC circuit breakers are suitable for isolation as defined by IEC 60947-1 and 60947-2:

- the isolation position corresponds to the O (OFF) position
- the operating handle and the indicators cannot indicate the OFF position unless the contacts are effectively open
- padlocks may not be installed unless the contacts are open.

The isolation function is certified by tests guaranteeing:

- the mechanical reliability of the position-indication system
- the absence of leakage currents
- overvoltage withstand capacity between upstream and downstream connections.

For Compact NSX DC, installation of a rotary handle or a motor mechanism does not alter the reliability of the position-indication system.



Circuit breaker characteristics

Compact NSX100 DC to NSX250 DC

A

PB106201.eps



PB106202.eps



PB107547_32.eps



Compact NSX DC circuit breaker

Basic frame	Number of poles		
Electrical characteristics as per IEC 60947-1/ 60947-2 and EN 60947-1 / 60947-2			
Rated current at 40 °C	In	(A)	
Rated insulation voltage	Ui	(V)	
Rated impulse withstand voltage	Uimp	(kV peak)	
Rated operational voltage	Ue	(V DC)	
Type of circuit breaker			
Ultimate breaking capacity (L/R = 5 ms and L/R = 15 ms)	Icu	(kA rms)	V DC 24-125 V (1P) ^[1] 250 V (1P) ^[1] 500 V (2P) ^[1] 750 V (3P) ^[1]
Service breaking capacity	Ics	% Icu	
Rated making capacity	Icm	% Icu	
Utilisation category			
Breaking time		(ms)	
Suitability for isolation			
Pollution degree (as per IEC 60664-1)			
Protection against overcurrents (see trip-unit table page A-19)			
Trip units			Built-in Interchangeable
Protection			Overloads Short-circuits
Durability			
(O/C cycles)			
	Mechanical		
	Electrical		250 V In 250 V In/2 500 V In 500 V In/2 750 V In 750 V In/2
Indication and control auxiliaries			
Auxiliary contacts			
Voltage release			MX shunt release MN undervoltage release
Installation and connections			
Fixed			Front connection Rear connection
Plug-in (base)			Front connection Rear connection
Withdrawable (chassis)			Front connection Rear connection
Control	Manual		with toggle with direct or extended rotary handle
	Electrical		with remote control
Dimensions and weight			
Dimensions	Fixed	(mm)	1P 2P 3P 4P
H x W x D (mm) connected in series			
Weight (kg)	Fixed	(kg)	1P 2P 3P 4P
connected in series			

[1] Number of poles in series taking part in current interruption.

Example. The NSX100N DC circuit breaker exists in the following versions:

- 1 pole with an Icu of 50 kA, for systems ≤ 250 V
- 2 poles with an Icu of 85 kA, for systems ≤ 500 V; 1 pole can be used in a 250 V system.

Circuit breaker characteristics

Compact NSX100 DC to NSX250 DC

NSX100 DC									NSX160 DC						NSX250 DC			
1			2			3/4			1		2		3/4		3/4			
100									160						250			
750									750						750			
8									8						8			
250			500			750			250		500		750		750			
F	N	M	F	M	S	F	S	F	N	M	F	M	S	F	S	F	S	
36	50	85	36	85	100	36	100	36	50	85	36	85	100	36	100	36	100	
36	50	85	36	85	100	36	100	36	50	85	36	85	100	36	100	36	100	
-	-	-	36	85	100	36	100	-	-	-	36	85	100	36	100	36	100	
-	-	-	-	-	-	36	100	-	-	-	-	-	-	36	100	36	100	
100 %									100 %						100 %			
100 %									100 %						100 %			
A									A						A			
< 10 ms									< 10 ms						< 10 ms			
3									3						3			
							-								-	-	-	
-	-	-	-	-	-			-	-	-	-	-	-					
10000									10000						10000			
5000									5000						5000			
10000									10000						10000			
5000									5000						5000			
10000									10000						10000			
5000									5000						5000			
10000									10000						10000			
-								-										
-								-										
-								-										
-	-	-	-	-	-			-	-	-	-	-	-					
-	-	-	-	-	-			-	-	-	-	-	-					
-	-	-	-	-	-			-	-	-	-	-	-					
-	-	-	-	-	-			-	-	-	-	-	-					
-	-	-	-	-	-			-	-	-	-	-	-					
161 x 35 x 86			-			-			161 x 35 x 86		-		-		-		-	
-			161 x 70 x 86			-			-		161 x 70 x 86		-		-		-	
-			-			161 x 105 x 86			-		-		161 x 105 x 86		-		-	
-			-			161 x 140 x 86			-		-		161 x 140 x 86		-		-	
0.7			-			-			0.7		-		-		-		-	
-			1.2			-			-		1.2		-		-		-	
-			-			1.6 to 1.9			-		-		1.6 to 1.9		-		-	
-			-			2.1 to 2.3			-		-		2.1 to 2.3		-		-	



Circuit breaker characteristics

Compact NSX400 DC to NSX1200 DC

PB114634-L30_reps



A

PB119834-L32_reps



Compact NSX DC circuit breaker

Basic frame	Number of poles		
-------------	-----------------	--	--

Electrical characteristics as per IEC 60947-1/ 60947-2 and EN 60947-1 / 60947-2

Rated current at 40 °C	In	(A)	
Rated insulation voltage	Ui	(V)	
Rated impulse withstand voltage	Uimp	(kV peak)	
Rated operational voltage	Ue	(V DC)	

Type of circuit breaker

Ultimate breaking capacity (L/R = 5 ms and L/R = 15 ms)	Icu	(kA rms)	V DC	24-125 V (1P) ^[1]
				250 V (1P) ^[1]
	Icu	(kA rms)	V DC	500 V (2P) ^[1]
				750 V (3P) ^[1]
				24-300 V (1P) ^[1]
				300-600 V (2P) ^[1]

Service breaking capacity	Ics	% Icu
Rated making capacity	Icm	% Icu
Utilisation category		
Breaking time		(ms)

Suitability for isolation	
Pollution degree (as per IEC 60664-1)	

Protection against overcurrents (see trip-unit table page A-19)

Trip units	Interchangeable
Protection	Overloads
	Short-circuits

Durability

(O/C cycles)	Mechanical	
	Electrical	250 V In
		250 V In/2
		500 V In
		500 V In/2
		750 V In
		750 V In/2
		600 V In
		600 V In/2

Indication and control auxiliaries

Auxiliary contacts	
Voltage release	MX shunt release
	MN undervoltage release

Installation and connections

Fixed		Front connection
		Rear connection
Plug-in (base)		Front connection
		Rear connection
Withdrawable (chassis)		Front connection
		Rear connection
Control	Manual	with toggle
		with direct or extended rotary handle
	Electrical	with remote control

Dimensions and weight

Dimensions H x W x D (mm) connected in series	Fixed	(mm)	1P
			2P
			3P
			4P
Weight (kg) connected in series	Fixed	(kg)	1P
			2P
			3P
			4P

[1] Number of poles in series taking part in current interruption.

Example. The NSX100N DC circuit breaker exists in the following versions:

- 1 pole with an Icu of 50 kA, for systems ≤ 250 V
- 2 poles with an Icu of 85 kA, for systems ≤ 500 V; 1 pole can be used in a 250 V system.

Circuit breaker characteristics

Compact NSX400 DC to NSX1200 DC

NSX400 DC						NSX630 DC				NSX1200 DC				
3/4						3/4				2				
250	320		400			500		600		630	800	1000	1200	
750	750		750			750		750		600	600	600	600	
8	8		8			8		8		8	8	8	8	
750	750		750			750		500		600	600	600	600	
F	S	F	S	F	S	F	S	F	S	N				
36	100	36	100	36	100	36	100	36	100	-	-	-	-	
36	100	36	100	36	100	36	100	36	100	-	-	-	-	
36	100	36	100	36	100	36	100	36	100	-	-	-	-	
36	100	36	100	36	100	36	100	-	-	-	-	-	-	
-	-	-	-	-	-	-	-	-	-	50	50	50	50	
-	-	-	-	-	-	-	-	-	-	50	50	50	50	
100 %						100 %				25 %				
100 %						100 %				100 %				
A														
10ms														
3														
-														
5000						5000				5000				-
1000						1000				1000				-
2000						2000				2000				-
1000						1000				1000				-
2000						2000				2000				-
1000						1000				-				-
2000						2000				-				-
-						-				-				1000
-						-				-				2000
										-	-	-	-	
										-	-	-	-	
										-	-	-	-	
										-	-	-	-	
-														
-														
255 x 140 x 110											350 x 185 x 110			
255 x 185 x 110														
-														
-														
8														
8.4														
-														
-														



Trip-unit characteristics

Types of trip units - Trip units for Compact NSX DC

A



Trip units for Compact NSX100 DC - NSX160 DC

Single-pole and two-pole (not interchangeable)

Type of trip unit		TM-D										
Rating	In (A) at 40 °C	16	20	25	30	40	50	63	80	100	125	160
Compact circuit breaker	NSX100N/H DC	⊙	⊙	⊙	⊙	⊙	⊙	⊙	⊙	⊙	-	-
	NSX160N/H DC	-	-	-	-	-	-	-	-	-	⊙	⊙

Overload protection (thermal)		Fixed										
Tripping threshold	Ir (A) at 40 °C	16	20	25	30	40	50	63	80	100	125	160

Protection against short-circuits (magnetic)		Fixed											
Pick-up	Im (A)	190	190	300	300	500	500	500	640	800	1000	1250	
Compact circuit breaker	NSX100/160N/H DC	Marked AC value ^[1]	190	190	300	300	500	500	500	640	800	1000	1250
		True DC value	260	260	400	400	700	700	700	800	1000	1200	1250

Trip units for Compact NSX100 DC - NSX160 DC - NSX250 DC

Three-pole 3P-3d and four-pole 4P-4d (interchangeable trip units)

Type of trip unit		TM-D							TM-DC				
Rating (A)	In (A) at 40 °C	16	25	32	40	50	63	80	100	125	160	200	250
Compact circuit breaker	NSX100 DC	⊙	⊙	⊙	⊙	⊙	⊙	⊙	⊙	-	-	-	-
	NSX160 DC	-	-	-	-	-	-	-	-	⊙	⊙	-	-
	NSX250 DC	-	-	-	-	-	-	-	-	-	-	⊙	⊙

Overload protection (thermal)		Adjustable											
Tripping threshold (A)	Ir (at 40 °C)	0.7 to 1 x In											

Protection against short-circuits (magnetic)		Fixed											Adjustable
Pick-up (A)	Im	190	300	400	500	500	500	-	-	-	-	-	-
Compact circuit breaker	NSX100/160/NSX250 DC	Marked AC value ^[1]	190	300	400	500	500	500	-	-	-	-	-
		True DC value	260	400	550	700	700	700	800	800	1250	1250	5 to 10 x In

Trip units for Compact NSX100 DC - NSX160 DC - NSX250 DC

Three-pole 3P-3d and four-pole 4P-4d (interchangeable trip units)

Type of trip unit		TM-G										
Rating (A)	In (A) at 40 °C	16	25	40	63	80	100	125	160	200	250	
Compact circuit breaker	NSX100 DC	⊙	⊙	⊙	⊙	⊙	⊙	-	-	-	-	
	NSX160 DC	-	-	-	-	-	-	⊙	⊙	-	-	
	NSX250 DC	-	-	-	-	-	-	-	-	⊙	⊙	

Overload protection (thermal)		Adjustable										
Tripping threshold (A)	Ir (at 40 °C)	0.7 to 1 x In										

Protection against short-circuits (magnetic)		Fixed										
Pick-up (A)	Im	63	80	80	125	200	320	-	-	-	-	-
Compact circuit breaker	Marked AC value ^[1]	NSX100 DC	63	80	80	125	200	320	-	-	-	-
		NSX160 DC	-	80	80	125	200	320	440	440	-	-
		NSX250 DC	-	-	-	-	200	320	440	-	440	520
	True DC value	NSX100 DC	80	100	100	150	250	400	530	530	530	625
	NSX160 DC	-	100	100	150	250	400	530	530	-	-	
	NSX250 DC	-	-	-	-	-	-	-	-	530	625	

[1] The pick-up values for single-pole and two-pole, TMD and TMG magnetic trip units up to 63 A are marked with AC values. A correction coefficient is required to obtain the DC pick-up values indicated on the next line. The magnetic-protection pick-up values for TM-DC trip units are indicated directly in DC values.

Trip units for Compact NSX400DC - NSX1200DC

Three-pole, four-pole (not interchangeable) / Two-pole (not interchangeable)

Type of trip unit		TM-DC									
Rating (A)	In(A) at 40 °C	250 ^[2]	320	400	500	600	630	800	1000	1200	
Compact circuit breaker	NSX400DC	⊙	⊙	⊙	-	-	-	-	-	-	
	NSX630DC	-	-	-	⊙	⊙	-	-	-	-	
	NSX1200DC	-	-	-	-	-	⊙	⊙	⊙	⊙	

Overload protection (thermal)		Adjustable 0.7 to 1 x in									
Tripping threshold (A)	Ir (at 40 °C)										

Protection against short-circuits (magnetic)		Adjustable 2.5 to 5 x in									
Pick-up (A)	Im										

[2] TM-DC 250 Adjustable range is 2.5 to 4 x In.

Types of trip units - Trip units for Compact NSX DC

Types of trip units

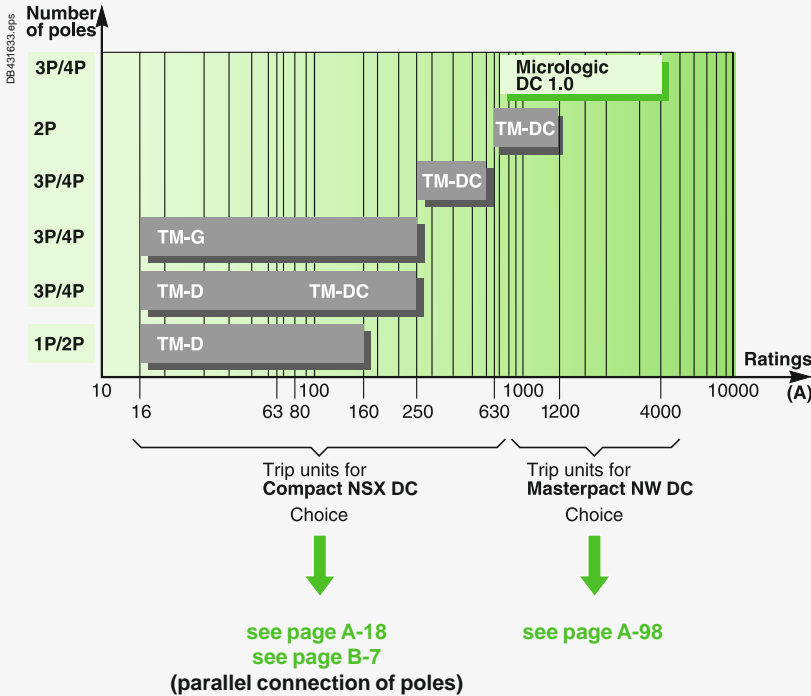

Trip units for Compact NSX DC

TM thermal-magnetic trip unit up to 1200 A

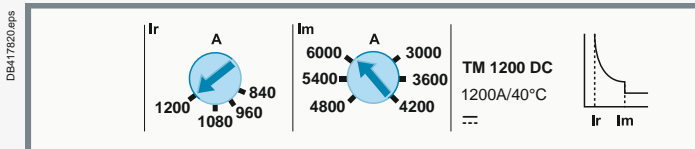

Up to 1200 A for Compact NSX DC, protection is provided by thermal-magnetic trip units.

- TM-D up to 160 A: fixed thermal threshold and magnetic pick-up.
- TM-D up to 63 A: adjustable thermal threshold and fixed magnetic pick-up.
- TM-DC from 80 to 250 A: fixed or adjustable (for 200 and 250 A) magnetic pick-up and adjustable thermal threshold.
- TM-DC from 250 A to 1200 A adjustable magnetic pick-up and adjustable thermal threshold.
- TM-G, up to 250 A: adjustable thermal threshold and fixed low magnetic pick-up to protect long cables.

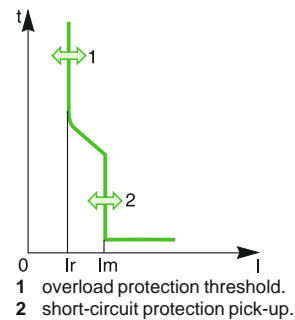

Switch-disconnectors

Characteristics and performance of Compact NSX switch-disconnectors from 100 to 250 NA

Installation standards require upstream protection. However Compact NSX100 to 630 NA switch-disconnectors are self-protected by their high-set magnetic release.

PE113960_L37_4988



Compact NSX100 to 250 NA.

A

Common characteristics

Rated voltages			
Insulation voltage (V)	Ui		750
Impulse withstand voltage (kV)	Uimp		8
Operational voltage (V)	Ue		750
Suitability for isolation		IEC/EN 60947-3	yes
Utilisation category		DC 22 A/DC 23 A	
Pollution degree		IEC 60664-1	3

Switch-disconnectors

Electrical characteristics as per IEC 60947-3 and EN 60947-3

Conventional thermal current (A)	Ith 60 °C		
Number of poles			
Operational current (A) depending on the utilisation category	Ie	DC	
			250 V (1 pole) 500 V (2 poles in series) 750 V (3 poles in series)
Short-circuit making capacity (kA peak)	Icm	min. (switch-disconnector alone) max. (protection by upstream NSX DC circuit breaker)	
Rated short-time withstand current (A rms)	Icw	for	1 s 3 s 20 s
Durability (C-O cycles)			
	mechanical		
	electrical	DC	250 V (1 pole) and In/2 500 V (2 poles in series)In

Positive contact indication

Pollution degree

Protection

Add-on earth-leakage protection By Vigirex relay

Additional indication and control auxiliaries

Indication contacts

Voltages releases MX shunt release
MN undervoltage release

Voltage-presence indicator

Current-transformer module

Ammeter module

Insulation monitoring module

Remote communication by bus

Device-status indication

Device remote operation

Operation counter

Installation / connections

Dimensions (mm)	fixed, front connections	2/3P
W x H x D		4P
Weight (kg)	fixed, front connections	3P 4P

Source-changeover systems

(see chapter on Source-changeover systems)

Manual source-changeover systems

Remote-operated or automatic source-changeover systems

[1] 2P in 3P case.

[2] Suitable for 480 V NEMA.

Note: for more information, please see catalogue Compact NSX LVPED208001EN.

Switch-disconnectors

Characteristics and performance of Compact NSX switch-disconnectors from 100 to 250 NA



Common characteristics			
Control			
Manual	With toggle		<input checked="" type="radio"/>
	With direct or extended rotary handle		<input checked="" type="radio"/>
	Electrical	With remote control	<input checked="" type="radio"/>
Versions			
Withdrawable	Fixed		<input checked="" type="radio"/>
	Plug-in base	Chassis	<input checked="" type="radio"/>

NSX100NA	NSX160NA	NSX250NA
100	160	250
2 ^[1] , 3, 4	2 ^[1] , 3, 4	2 ^[1] , 3, 4
DC22A / DC23A	DC22A / DC23A	DC22A / DC23A
100	160	250
100	160	250
100	160	250
2.6	3.6	4.9
100	100	100
1800	2500	3500
1800	2500	3500
690	960	1350
50000	40000	20000
10000	10000	10000
5000	5000	5000
<input checked="" type="radio"/>	<input checked="" type="radio"/>	<input checked="" type="radio"/>
3	3	3
<input checked="" type="radio"/>		
<input checked="" type="radio"/>		
<input checked="" type="radio"/>		
<input checked="" type="radio"/>		
<input checked="" type="radio"/>		
<input checked="" type="radio"/>		
<input checked="" type="radio"/>		
<input checked="" type="radio"/>		
<input checked="" type="radio"/>		
<input checked="" type="radio"/>		
<input checked="" type="radio"/>		
105 x 161 x 86		
140 x 161 x 86		
1.5 to 1.8		
2.0 to 2.2		
<input checked="" type="radio"/>		
<input checked="" type="radio"/>		

Switch-disconnectors characteristics

Compact NSX400/630 NA DC



Compact NSX630 NA DC.



Compact NSX630 NA DC.

Compact NSX DC switch-disconnector

Number of poles

Electrical characteristics as per IEC 60947-3

Rated current (A) (free air + no venting)	I_n	40 °C
Altitude	m	2000
Rated insulation voltage (V)	U_i	
Rated impulse withstand voltage (kV)	U_{imp}	
Rated operational voltage (V)	U_e	DC

Type of circuit breaker

Rated short circuit withstand current (kA rms)	I_{cw}/I_{cm}	$t = 1\text{ s}$
Rated conditionnal short-circuit current	I_q	kA
	with back-up fuse	A gG
Rated conditionnal short-circuit current	I_q with NSX DC circuit breaker	kA with MCCB

Utilization category
Suitability for isolation

Pollution degree

Durability

Endurance (C-O cycles)	mechanical	
	electrical (I_n)	750 V

Installation and connections

Control	manual	toggle
		direct or extended rotary handle
	motor mechanism	
Connections	fixed	front connection
		long rear connection
	plug-in (on base)	front connection
		rear connection
	withdrawable (on chassis)	front connection
		rear connection

Additional measurement, indication and control auxiliaries

Indication contacts	OF	auxiliary contact
	SD, SDE	trip, fault-trip
Voltage releases	MX, MN	shunt trip/undervoltage release

Installation

Accessories	crimp lugs / bare cable connector
	terminal extensions and spreaders
	escutcheons
	terminal shields and interphase barriers
	Din rail adapter

Dimensions and weight

Dimensions (mm) H x W x D (w/o series connection)	3P
	4P
Weight (kg) (w/o series connection)	3P
	4P

Accessories and auxiliaries

Overview of Compact NSX100 to 630 DC [*] fixed version

A

Insulation accessories

DBA31634.eps

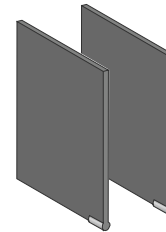
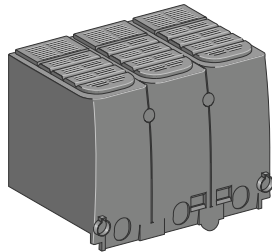

Interphase barriers

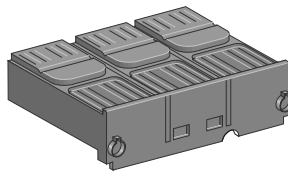

Sealable terminal shields

Electrical auxiliaries ► A-39



Indication contact

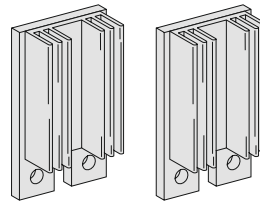

Heat sink



Voltage release

Protection and measurements

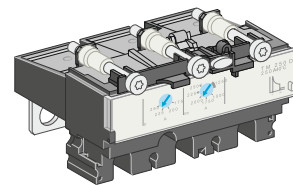

TM-D, TM-G trip unit

[*] Applicable for circuit breaker up to 600 A see page A-16.

Accessories and auxiliaries

Overview of Compact NSX100 to 630 DC [*] fixed version

Connection ► A-32

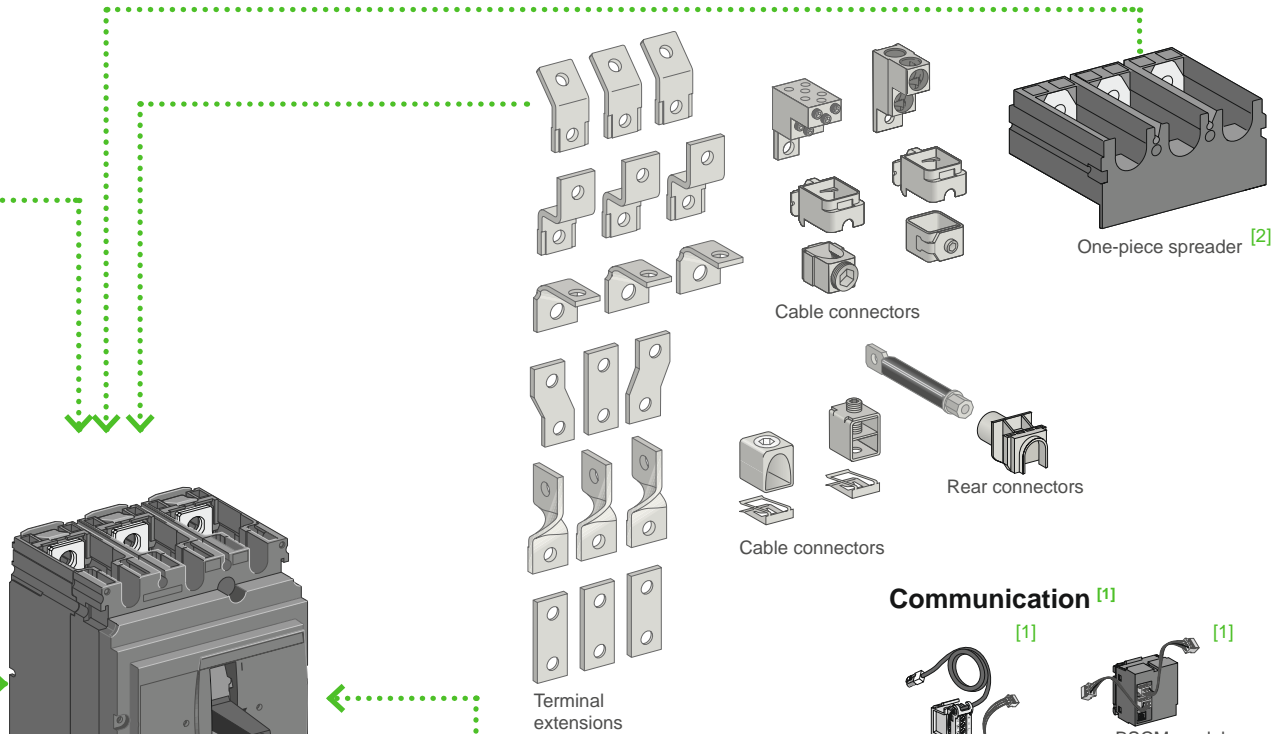

Communication [1]

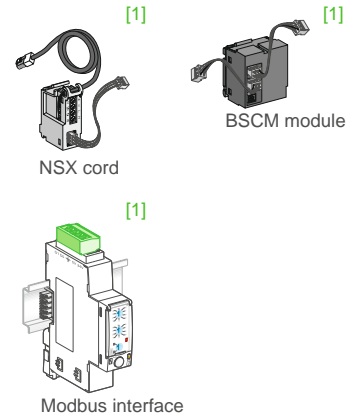

Control accessories ► A-40

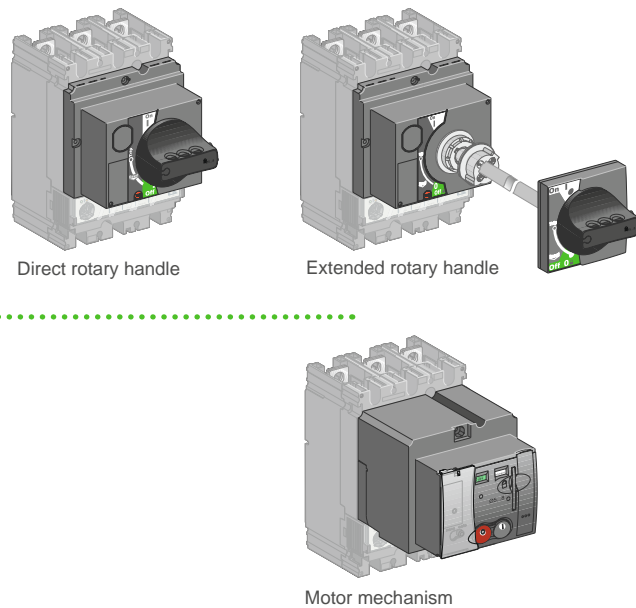

[1] See communication chapter.
 [2] Only for Compact NSX100-250.

Accessories and auxiliaries

Overview of Compact NSX1200 DC fixed version

Insulation accessories

DB43 1635.eps

A

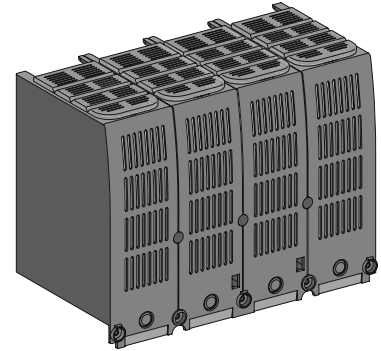

Sealable terminal shields



Indication contact



Voltage release

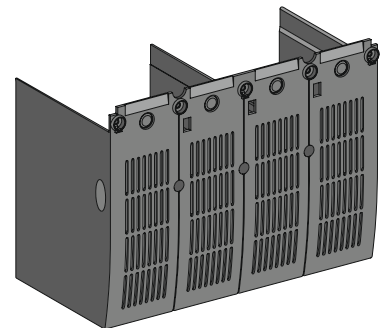
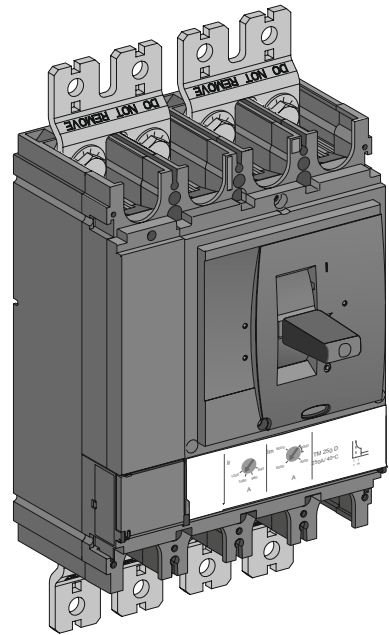

Sealable terminal shields

Accessories and auxiliaries

Overview of Compact NSX1200 DC fixed version

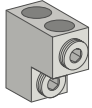

Cable connectors



NSX cord

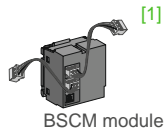

BSCM module

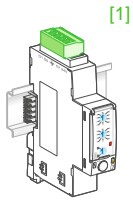

Modbus interface

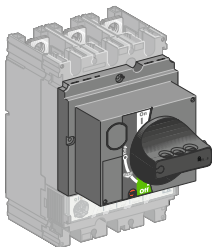

Direct rotary handle

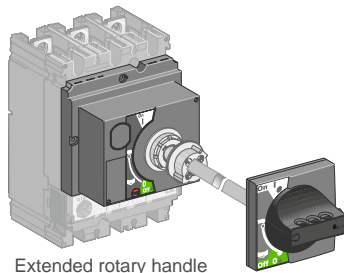

Extended rotary handle

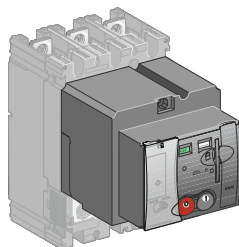

Motor mechanism

[1] See communication chapter.



Accessories and auxiliaries

Overview of Compact NSX100 to 630 DC [1] plug-in and withdrawable versions

A

Insulation accessories

DB431636.eps



Interphase barriers

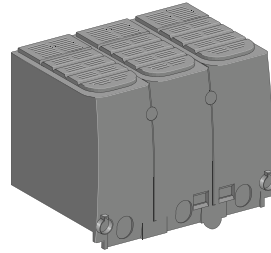

Sealable long terminal shields for plug-in base

Electrical accessories ► A-34

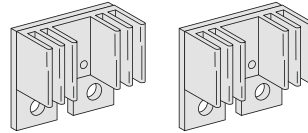

Heat sink

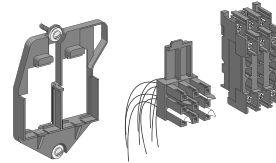

Automatic withdrawable auxiliary connector

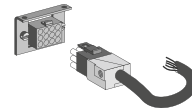

Manual auxiliary connector

Mechanical accessories ► A-31

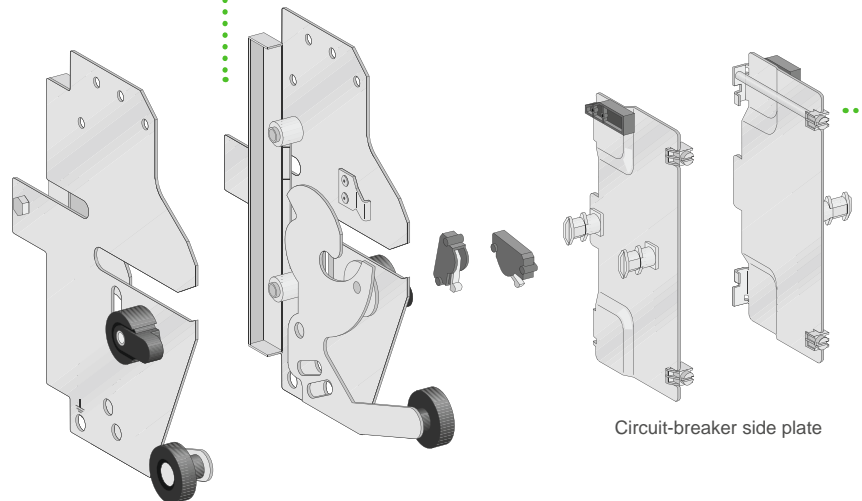

Chassis side plate

Circuit-breaker side plate

[1] Applicable for circuit breaker up to 600 A see page A-16.

Accessories and auxiliaries

Overview of Compact NSX100 to 630 DC [1] plug-in and withdrawable versions

Connection ▶ A-32

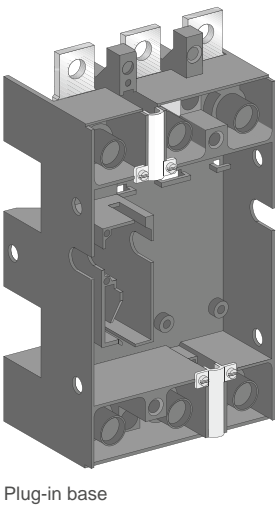
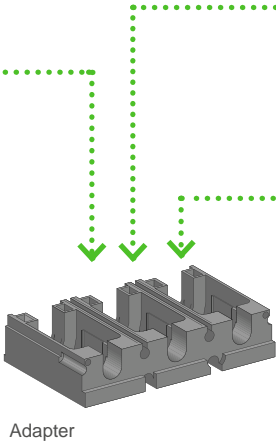
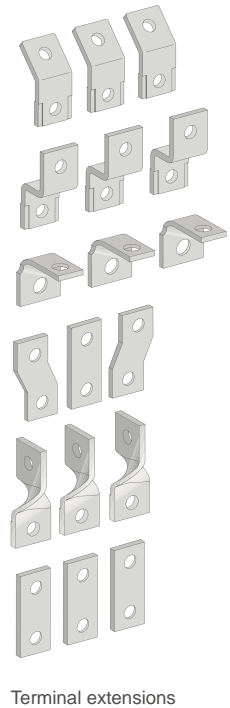
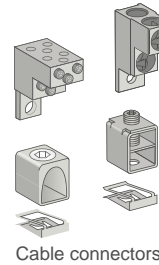
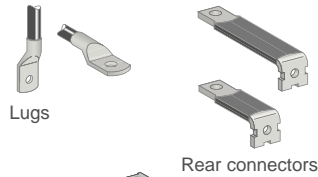
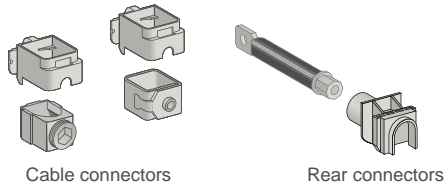

Circuit breaker

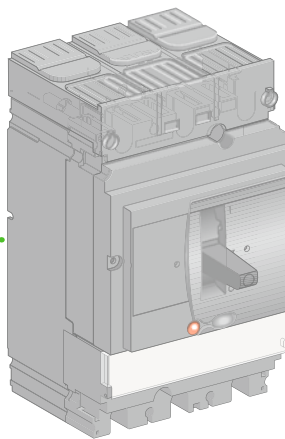

Power connection accessories

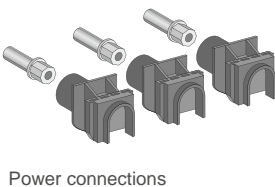

Electrical and mechanical accessories

Compact NSX100 to 1200 DC

Compact NSX DC circuit breakers may be installed horizontally, vertically or flat on their back, without derating performance levels.

There are three installation versions:

- fixed
- plug-in (on a base)
- withdrawable (on a chassis).

For the last two, components must be added (base, chassis) to the fixed version. Many connection components are shared by the three versions.

A

Fixed circuit breakers NSX100 to NSX1200

Fixed circuit breakers are designed for standard connection using bars or cables with lugs. Bare-cable connectors are available for connection to bare copper or aluminium cables.

For connection of large cables, a number of solutions with spreaders may be used for both cables with lugs or bare cables.

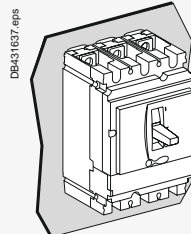

Mounting on a backplate.

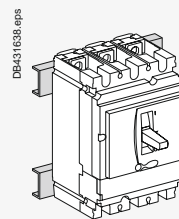

Mounting on rails.

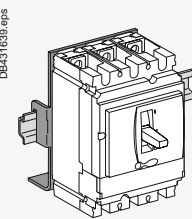

Mounting on DIN rail (with adapter).

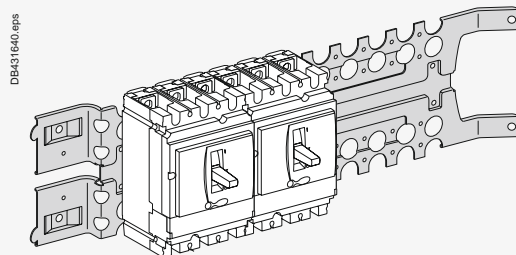

Mounting on a Prisma mounting plate.

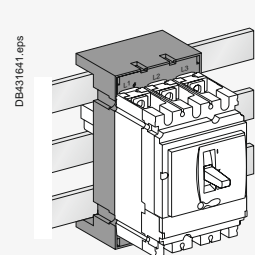

Mounting on busbars with an adapter.



Fixed Compact NSX250 DC.

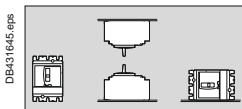

Installation positions.



Plug-in Compact NSX250 DC.

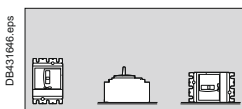

Installation positions.

Plug-in base circuit breakers NSX100 to NSX630 [1]

The plug-in version makes it possible to:

- extract and/or rapidly replace the circuit breaker without having to touch the connections on the base
- allow for the addition of future circuits by installing bases that will be equipped with a circuit breaker at a later date
- isolate the power circuits when the device is mounted on or through a panel. It acts as a barrier for the connections of the plug-in base. Insulation is made complete by the mandatory short terminal shields on the device. The degrees of protection are:
 - circuit breaker plugged in = IP4
 - circuit breaker removed = IP2
 - circuit breaker removed, base equipped with shutters = IP4.

Parts of a plug-in configuration

A plug-in configuration is made by adding a "plug-in kit" to a fixed device. To avoid connecting or disconnecting the power circuits under load conditions, a safety trip causes automatic tripping if the device is ON, before engaging or withdrawing it. The safety trip, supplied with the kit, must be installed on the device. If the device is disconnected, the safety trip does not operate. The device can be operated outside the switchboard.

Accessories

Optional insulation accessories are available.

- Terminal shields to protect against direct contact.
- Interphase barriers to reinforce insulation between phases and protect against direct contact.

Mounting

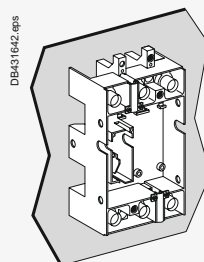

Mounting on a backplate.

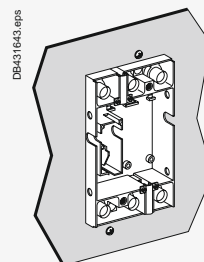

Mounting through a front panel.

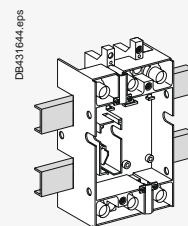

Mounting on rails.

[1] Applicable for circuit breaker up to 600 A see page A-14 to A-17.

Electrical and mechanical accessories

Compact NSX100 to 1200 DC

Withdrawable circuit breakers NSX100 to NSX630 [1]

In addition to the advantages provided by the base, installation on a chassis facilitates handling. It offers three positions, with transfer from one to the other after mechanical unlocking:

- connected: the power circuits are connected
- disconnected: the power circuits are disconnected, the device can be operated to check auxiliary operation
- removed: the device is free and can be removed from the chassis.

Parts of a withdrawable configuration

A withdrawable configuration requires two side plates installed on the base and two sides plates mounted on the circuit breaker. Similar to the plug-in version, a safety trip causes automatic tripping if the device is ON, before engaging or withdrawing it, and enables device operation in the disconnected position.

Accessories

Accessories are the same as for the base, with in addition:

- auxiliary contacts for installation on the fixed part, indicating the "connected" and "disconnected" positions
- locking by 1 to 3 padlocks (shackle diameter 5 to 8 mm), to:
 - prevent insertion for connection
 - lock the circuit breaker in connected or disconnected position
- toggle collar for circuit breakers with a toggle mounted through a front panel, intended to maintain the degree of protection whatever the position of the circuit breaker (supplied with a toggle extension)
- telescopic shaft for extended rotary handles. The door can then be closed with the device in the connected and disconnected positions.

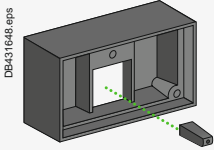

Protection collar for toggle and toggle extension to provide IP4 in the connected and disconnected positions.

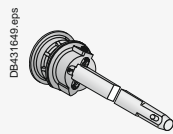

Telescopic shaft.

Mounting

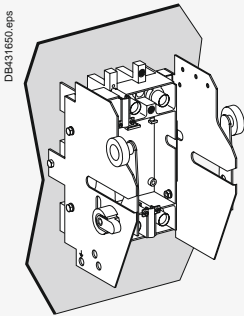

Mounting on a backplate.

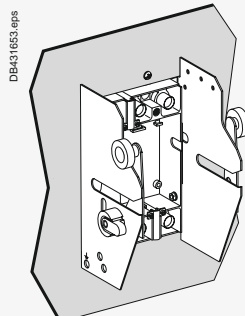

Mounting through a front panel.

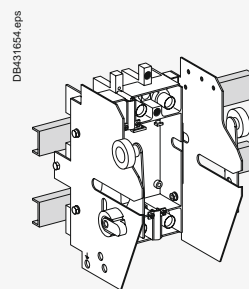

Mounting on rails.

[1] Applicable for circuit breaker up to 600 A see page A-14 to A-17.

- Disconnected position - the power circuits are disconnected, but the circuit breaker is still on the chassis and may still be operated (ON, OFF, push-to-trip).
- The circuit breaker may be locked using 1 to 3 padlocks (shackle diameter 5 to 8 mm), to prevent connection.
- The auxiliaries can be tested (with manual auxiliary connector).



Withdrawable Compact NSX250 DC.

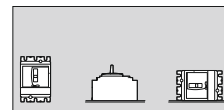

Installation positions.

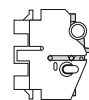

Connected.

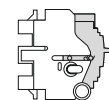

Disconnected.

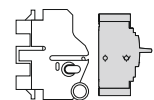

Removed.

Electrical and mechanical accessories

Connection of fixed devices

Fixed circuit breakers are designed for standard front connection using bars or cables with lugs. Cable connectors are available for bare cables. Rear connection is also possible.

A

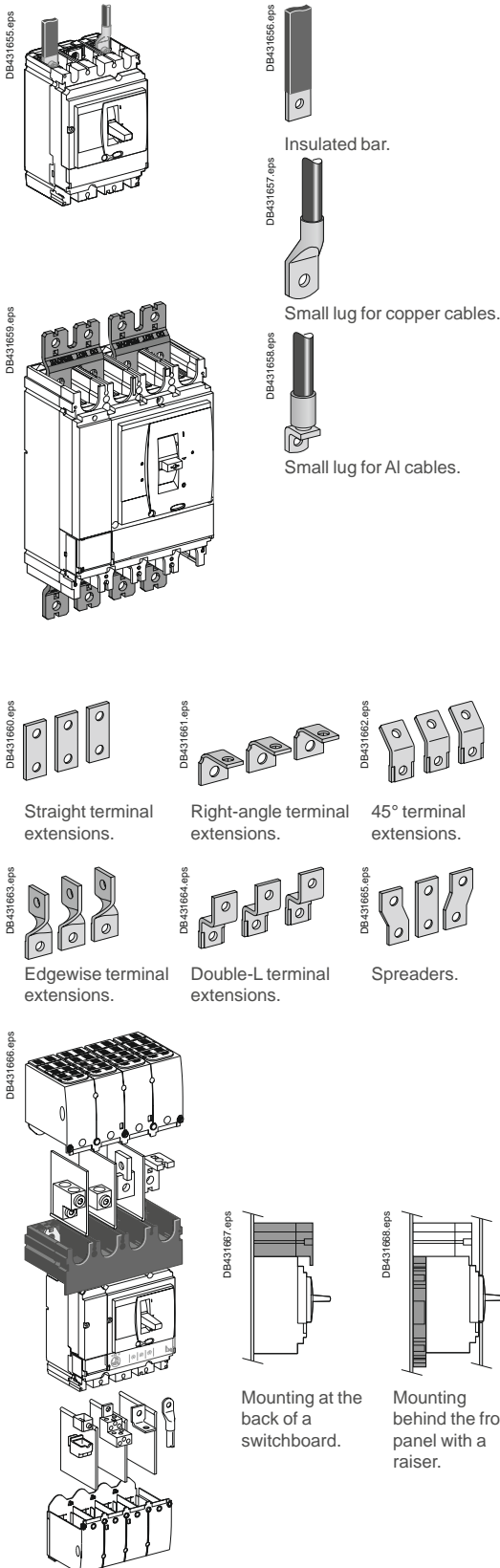

Front connection

Bars or cables with lugs

Standard terminals

Compact NSX100 to 630 DC come with terminals comprising snap-in nuts with screws:

- Compact NSX100/160/250 DC: M8 nuts and screws
- Compact NSX400/630 DC: M10 nuts and screws.

These terminals may be used for:

- direct connection of insulated bars or cables with lugs
- terminal extensions offering a wide range of connection possibilities.

Interphase barriers or terminal shields are recommended. They are mandatory for certain connection accessories (in which case the interphase barriers are provided).

Bars

When the switchboard configuration has not been tested, insulated bars are mandatory.

Maximum size of bars

Compact NSX DC circuit breaker	100 to 250	400 to 630	1200	
Without spreaders	pitch (mm)	35	45	45
	maximum bar size (mm)	20 x 2	32 x 6	2 x (32 x 6)
With spreaders	pitch (mm)	45	52.5	-
	maximum bar size (mm)	32 x 2	40 x 6	-

Crimp lugs

There are two models, for aluminium and copper cables.

It is necessary to use narrow lugs, compatible with device connections. They must be used with interphase barriers or long terminal shields. The lugs are supplied with interphase barriers and may be used for the types of cables listed below.

Cable sizes for connection using lugs

Compact NSX DC circuit breaker	100 to 250	400 to 630	630 to 1200	
Copper cables	size (mm ²)	120, 150, 185	240, 300	185, 2 x 185
	crimping	hexagonal barrels or punching		
Aluminium cables	size (mm ²)	120, 150, 185	240, 300	185, 2 x 185
	crimping	hexagonal barrels		

Terminal extensions

Extensions with anti-rotation ribs can be attached to the standard terminals to provide numerous connection possibilities in little space:

- straight terminal extensions
- right-angle terminal extensions
- edgewise terminal extensions
- double-L extensions
- 45° extensions.

Spreaders

Spreaders may be used to increase the pitch:

- NSX100 to 250 DC: the 35 mm pitch can be increased to 45 mm
- NSX400/630 DC: the 45 mm pitch can be increased to 52 or 70 mm.

Bars, cable lugs or cable connectors can be attached to the ends.

One-piece spreader for NSX100 to 250 DC

Connection of large cables may require an increase in the distance between the device terminals.

The one-piece spreader is the means to:

- increase the 35 mm pitch of the NSX100 to 250 DC circuit breaker terminals to the 45 mm pitch of a NSX400/630 DC device
- use all the connection and insulation accessories available for the next largest frame size (lugs, connectors, spreaders, right-angle and edgewise terminal extensions, terminal shields and interphase barriers).

It may also be used for Compact INS switch-disconnectors.

Equipped with a single-piece spreader, Compact NSX DC devices can be mounted:

- at the back of a switchboard
- behind the front panel with a raiser.

The one-piece spreader is also the means to:

- align devices with different frame sizes in the switchboard
- use the same mounting plate, whatever the device.

Pitch (mm) depending on the type of spreader

Compact NSX DC circuit breaker	100 to 250	400 to 630
Without spreaders	35	45
With spreaders	45	52.5 or 70
With one-piece spreader	45	-

Electrical and mechanical accessories

Connection of fixed devices

Bare cables

For bare cables (without lugs), the prefabricated bare-cable connectors may be used for both copper and aluminium cables.

1-cable connector for Compact NSX100 to 250 DC

The connectors snap directly on to the device terminals or are secured by clips to right-angle and straight terminal extensions as well as spreaders.

1-cable connector for Compact NSX400 to 630 DC

The connectors are screwed directly to the device terminals.

2-cable connector for Compact NSX100 to 250 and 400/630/1200 DC

The connectors are screwed to device terminals or right-angle terminal extensions.

Distribution connectors for Compact NSX100 to 250 DC

These connectors are screwed directly to device terminals. Interphase barriers are supplied with distribution connectors, but may be replaced by long terminal shields. Each connector can receive six cables with cross-sectional areas ranging from 1.5 to 35 mm² each.

Maximum size of cables depending on the type of connector

Compact NSX DC circuit breaker		100/160	250	400	630	1200
Steel connectors	1.5 to 95 mm ²	●				
Aluminium connectors	25 to 95 mm ²	●	●			
	120 to 185 mm ²	●	●			
	2 cables 50 to 120 mm ²	●	●			
	2 cables 35 to 240 mm ²			●	●	●
	35 to 300 mm ²			●	●	
Distribution connectors	6 cables 35 mm ²	●	●			

Rear connection (up to rated current 600 A)

Device mounting on a backplate with suitable holes enables rear connection.

Bars or cables with lugs

Rear connections for bars or cables with lugs are available in two lengths. Bars may be positioned flat, on edge or at 45° angles depending on how the rear connections are positioned.

The rear connections are simply fitted to the device connection terminals. All combinations of rear connection lengths and positions are possible on a given device.

Bare cables

For the connection of bare cables, the 1-cable connectors for Compact NSX100 to 250 DC may be secured to the rear connections using clips.

Accessories for series and parallel connection (up to rated current 600 A)

A limited number of accessories can be used to optimise series and parallel connection of poles.

Accessories for series connection

These include series connection plates, equipped with heat sinks.

Accessories for parallel connection

Parallel pole connection accessories are identical to those for series connections. They are equipped with heat sinks. Customer connections are made directly to the connection plates after removing the heat sinks.

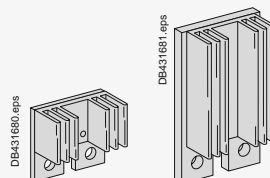

Series connection plates equipped with heat sinks.

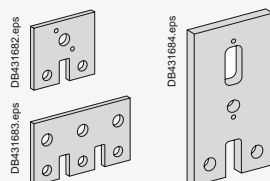

Parallel connection plates.

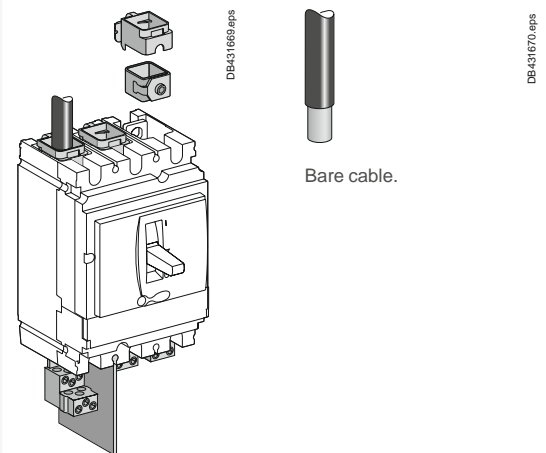

Bare cable.

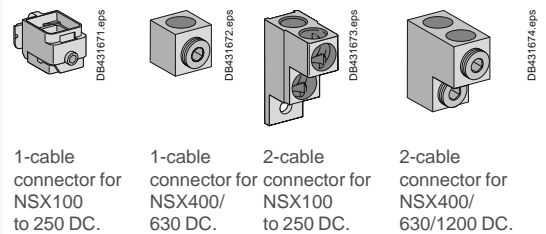

1-cable connector for NSX100 to 250 DC.

1-cable connector for NSX400/630 DC.

2-cable connector for NSX100 to 250 DC.

2-cable connector for NSX400/630/1200 DC.

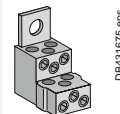

Distribution connector for NSX100 to 250 DC.

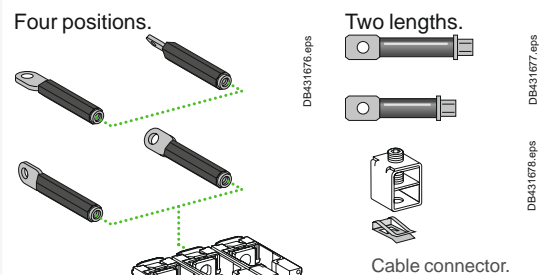

Four positions.

Two lengths.

Cable connector.

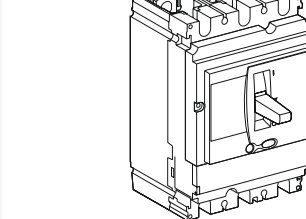

Rear connection.

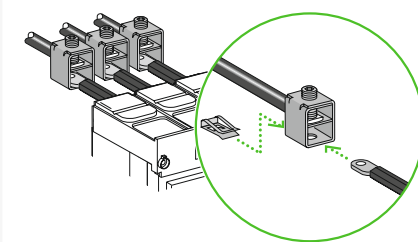

Connection of bare cables to NSX100 to 250 DC by clips.



Functions and characteristics

Electrical and mechanical accessories

Connection of electrical auxiliaries

A

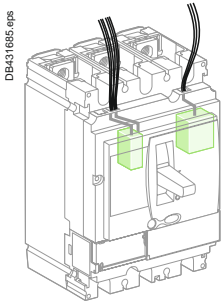

Fixed Compact NSX DC.

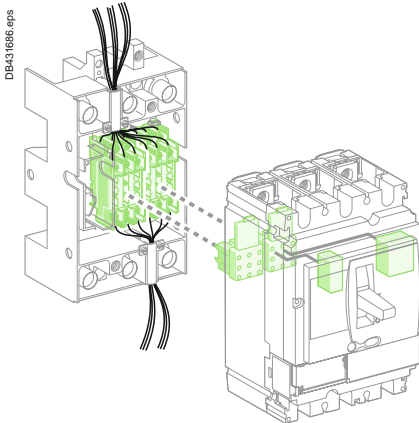

Plug-in/withdrawable Compact NSX DC.

Fixed Compact NSX100-250 DC

Auxiliary circuits exit the device through a knock-out in the front cover.

Withdrawable or plug-in Compact NSX DC

Automatic auxiliary connectors

Auxiliary circuits exit the circuit breaker via one to three automatic auxiliary connectors (nine wires each). These are made up of:

- a moving part, connected to the circuit breaker via a support (one support per circuit breaker)
- a fixed part, mounted on the plug-in base, equipped with connectors for bare cables up to 2.5 mm².

Micrologic trip unit options are also wired via the automatic auxiliary connectors.

Selection of automatic auxiliary connectors

Depending on the functions installed, one to three automatic auxiliary connectors are required.

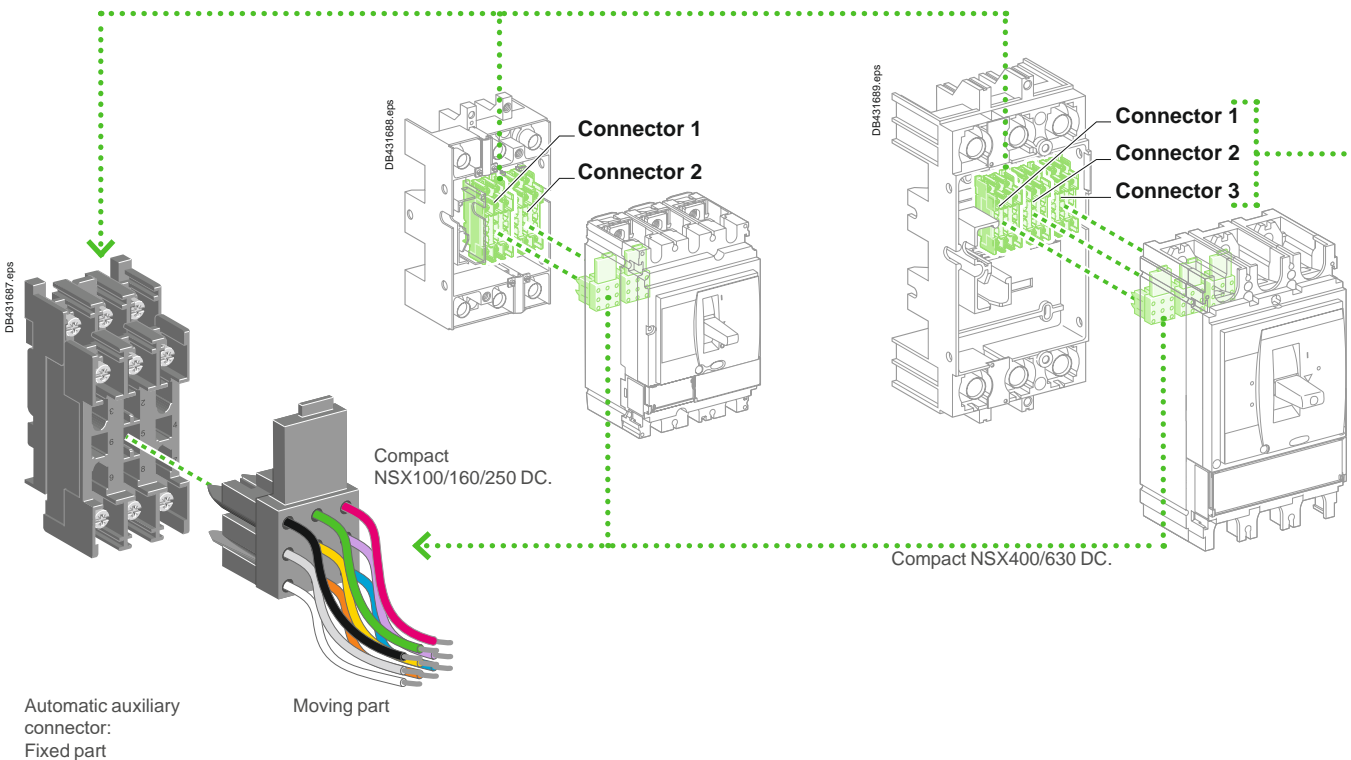

Electrical and mechanical accessories

Connection of electrical auxiliaries

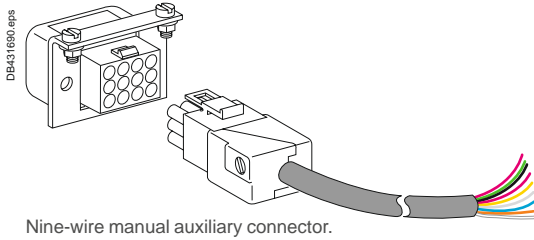

Withdrawable Compact NSX DC

Manual auxiliary connectors

As an option to the automatic auxiliary connectors, withdrawable circuit breakers may be equipped with one to three plugs with nine wires each. In "disconnected" position, the auxiliaries remain connected. They can then be tested by operating the device.

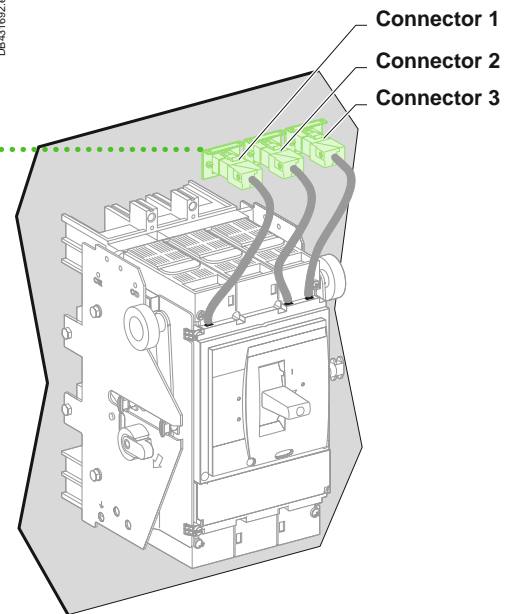
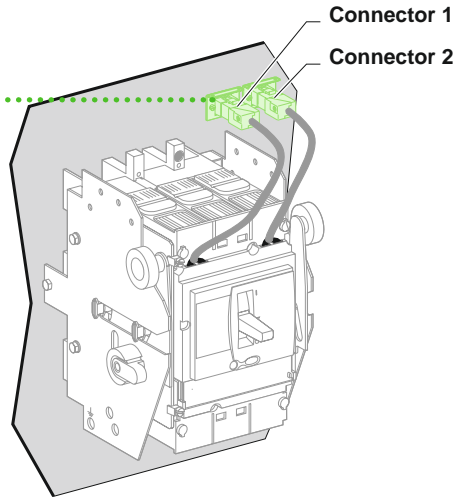

Each auxiliary is equipped with a terminal block with numbered terminals for connection of wires up to:

- 1.5 mm² for auxiliary contacts and voltage releases
- 2.5 mm² for the motor mechanism module.

Circuit breaker	Connector 1	Connector 2	Connector 3
	OF1 MN/MX SD	OF2 SDE NSX cord MT 24 V DC	OF3
NSX100/160/250 DC	●	●	-
NSX400/630 DC	●	●	●

MT: motor mechanism.



Electrical and mechanical accessories

Selection of auxiliaries for Compact NSX100/160/250 DC

044313_30_SE.eps



A

Remote tripping

MX or MN voltage releases are used to trip the circuit breaker.

MN undervoltage release

This release trips the circuit breaker when the control voltage drops below a tripping threshold:

- tripping threshold between 0.35 and 0.7 times the rated voltage
- circuit breaker closing is possible if the voltage exceeds 0.85 times the rated voltage. For a lower value, circuit breaker closing cannot be guaranteed.

Circuit breaker tripping by an MN release meets the requirements of standard IEC 60947-2.

Time-delay unit for an MN release

Eliminates nuisance tripping due to transient voltage dips lasting 200 ms.

It is used in conjunction with:

- a 250 V DC MN release, control voltage 220/240 V AC
- a 48 V DC MN release, control voltage 48 V AC.

MX shunt release

Trips the circuit breaker when the control voltage rises above $0.7 \times U_n$.

Control signals can be of the impulse type (≥ 20 ms) or maintained.

Operation

When the circuit breaker has been tripped by an MN or MX release, it must be reset locally.

MN or MX tripping takes priority over manual closing.

In the presence of a standing trip order, closing of the contacts, even temporary, is not possible.

Mechanical characteristics

- Endurance is equal to 50 % of the mechanical endurance of the circuit breaker.
- The releases clip in behind the front cover.
- Connection using wires up to 1.5 mm^2 , to integrated terminal blocks.

Electrical characteristics

- Consumption:
 - pick-up (MX): $< 30 \text{ VA}$
 - seal-in (MN and MNR): $< 5 \text{ VA}$.
- Response time: $< 50 \text{ ms}$.

NA, TMD, TMG

Standard

DB431683.eps

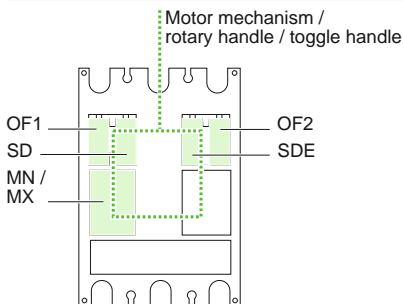

DB431684.eps

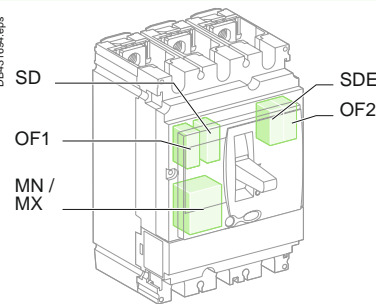

Electrical and mechanical accessories

Selection of auxiliaries for Compact NSX100/160/250 DC

Communication

Communication requires specific auxiliaries (see page A-42).

Communication of status indications ^[1]

- 1 BSCM module.
 - 1 NSX cord (internal terminal block) for both communication and 24 V DC supply to the BSCM.
- Communication of status conditions is compatible with a toggle handle and a rotary handle.

Communication of status indications and controls

- This requires, in addition to the previous auxiliaries:
- 1 IFM connected to the BSCM.



TMD, TMG

Communication of status indications ^[1]

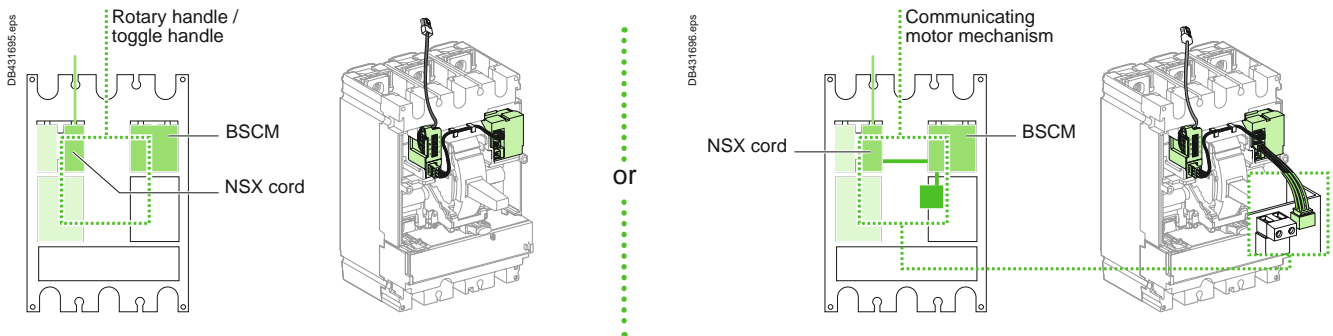

[1] Compact NSX100-250 DC only.

Electrical and mechanical accessories

Selection of auxiliaries for Compact NSX400/630/1200 DC

A

Standard

All Compact NSX400/630/1200 DC circuit breakers and switch-disconnectors have slots for the electrical auxiliaries listed below.

5 indication contacts (see page A-39)

- 3 ON/OFF (OF1, OF2, OF3)
- 1 trip indication (SD)
- 1 fault-trip indication (SDE).

1 remote-tripping release (see page A-43)

- Either 1 MN undervoltage release.
- Or 1 MX shunt release.

All these auxiliaries may be installed with a motor mechanism or a rotary handle or toggle handle.

NSX400/630/1200 DC

Standard

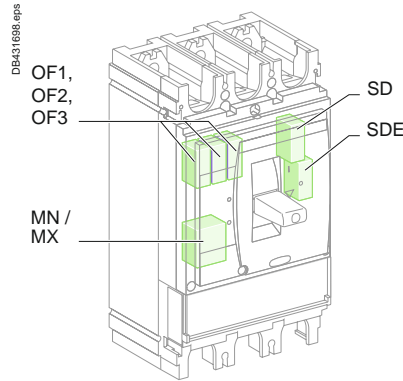
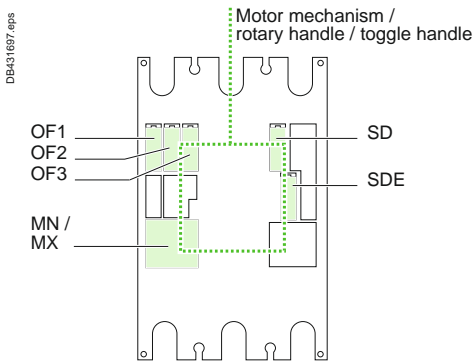

Communication of status indications

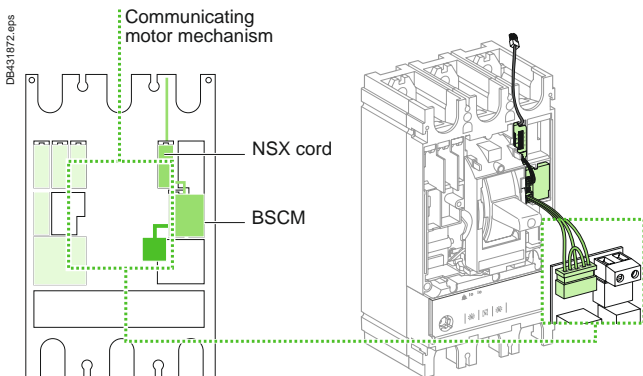

Communication of status indications and controls

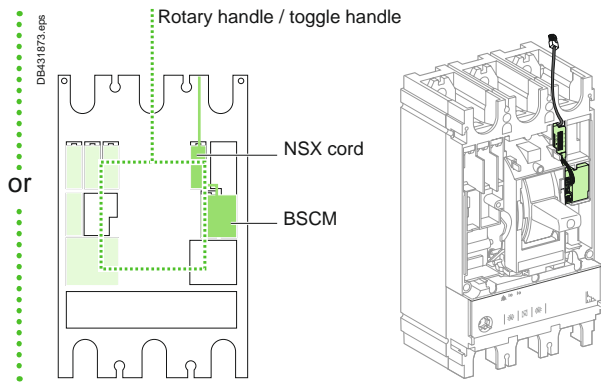

Electrical and mechanical accessories

Indication contacts for Compact NSX DC



One contact model provides circuit breaker status indications (OF - SD - SDE).
 An early-make or early-break contact, in conjunction with a rotary handle, can be used to anticipate device opening or closing.
 A CE / CD contact indicates that the chassis is connected / disconnected.

These common-point changeover contacts provide remote circuit breaker status information.
 They can be used for indications, electrical locking, relaying, etc.
 They comply with the IEC 60947-5 international recommendation.

Functions

Breaker-status indications, during normal operation or after a fault

A single type of contact provides all the different indication functions:

- OF (ON/OFF) indicates the position of the circuit breaker contacts
- SD (trip indication) indicates that the circuit breaker has tripped due to:
 - an overload
 - a short-circuit
 - operation of a voltage release
 - operation of the "push to trip" button
 - disconnection when the device is ON.

The SD contact returns to de-energised state when the circuit breaker is reset.

- SDE (fault-trip indication) indicates that the circuit breaker has tripped due to:
 - an overload
 - a short-circuit.

The SD contact returns to de-energised state when the circuit breaker is reset.

Rotary-handle position contact for early-make or early-break functions

■ CAM (early-make or early-break function) contacts indicate the position of the rotary handle.

They are used in particular for advanced opening of safety trip devices (early break) or to energise a control device prior to circuit breaker closing (early make).

Chassis-position contacts

■ CE/CD (connected/disconnected) contacts are microswitch-type carriage switches for withdrawable circuit breakers.



Indication contacts.

DB125448.eps

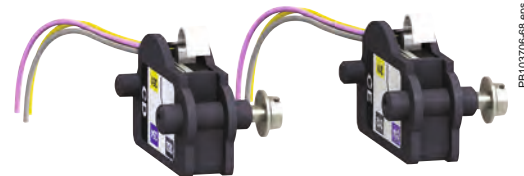

CE/CD carriage switches.

PB103706-618.eps

Installation

■ OF, SD, SDE functions: a single type of contact provides all these different indication functions, depending on where it is inserted in the device. The contacts clip into slots behind the front cover of the circuit breaker.

The SDE function on a Compact NSX100 - 250 DC equipped with a thermal-magnetic trip unit requires the SDE actuator.

- CAM function: the contact fits into the rotary-handle unit (direct or extended).
- CE/CD function: the contacts clip into the fixed part of the chassis.

Electrical characteristics of auxiliary contacts

Contacts		Standard				Low level			
Types of contacts		All				OF, SD, SDE			
Rated thermal current (A)		6				5			
Minimum load		100 mA at 24 V DC				1 mA at 4 V DC			
Utilisation cat. (IEC 60947-5-1)		AC12	AC15	DC12	DC14	AC12	AC15	DC12	DC14
Operational current (A)	24 V AC/DC	6	6	6	1	5	3	5	1
	48 V AC/DC	6	6	2.5	0.2	5	3	2.5	0.2
	110 V AC/DC	6	5	0.6	0.05	5	2.5	0.6	0.05
	220/240 V AC	6	4	-	-	5	2	-	-
	250 V DC	-	-	0.3	0.03	5	-	0.3	0.03
	380/440 V AC	6	2	-	-	5	1.5	-	-
480 V AC	6	1.5	-	-	5	1	-	-	
660/690 V AC	6	0.1	-	-	-	-	-	-	

Electrical and mechanical accessories

Rotary handles for Compact NSX DC

There are two types of rotary handle:

- direct rotary handle
- extended rotary handle.

There are two models:

- standard with a black handle
- red handle and yellow front for machine-tool control.

A

PB104936-eps



Compact NSX DC with a rotary handle.

PB103807-50-eps



Compact NSX DC with an MCC rotary handle.

PB103808-50-eps



Compact NSX DC with a CNOMO machine-tool rotary handle.

Direct rotary handle

Standard handle

Degree of protection IP40, IK07.

The direct rotary handle maintains:

- visibility of and access to trip-unit settings
- suitability for isolation
- indication of the three positions O (OFF), I (ON) and tripped
- access to the "push to trip" button.

Device locking

The rotary handle facilitates circuit breaker locking.

- Padlocking:
 - standard situation, in the OFF position, using 1 to 3 padlocks, shackle diameter 5 to 8 mm, not supplied
 - with a simple modification, in the ON and OFF positions. Locking in the ON position does not prevent free circuit breaker tripping if a fault occurs. In this case, the handle remains the ON position after the circuit breaker tripping. Unlocking is required to go to the tripped then the OFF position.

- Keylock (and padlock)

It is possible to install a Ronis or Profalux keylock (optional) on the base of the handle to obtain the same functions as with a padlock.

Early-make or early-break contacts (optional)

Early-make and/or early-break contacts may be used with the rotary handle. It is thus possible to:

- supply an MN undervoltage release before the circuit breaker closes
- open the contactor control circuit before the circuit breaker opens.

MCC switchboard control

Control of an MCC switchboard is achieved by adding a kit to the standard handle. In addition to the standard functions, the kit offers the characteristics listed below.

Higher degree of protection IP

Degree of protection IP43, IK07.

The IP is increased by a built-in gasket.

Door locking depending on device position

- The door cannot be opened if the circuit breaker is ON or in the tripped position. For exceptional situations, door locking can be temporarily disabled with a tool to open the door when the circuit breaker is closed. This operation is not possible if the handle is locked by a padlock.
- Circuit breaker closing is disabled if the door is open. This function can be deactivated.

Machine-tool control in compliance with CNOMO

Control of a machine-tool is achieved by adding a kit to the standard handle. In addition to the standard functions, the kit offers the characteristics listed below.

Enhanced waterproofness and mechanical protection

- Degree of protection IP54, IK08.
- Compliance with CNOMO E03.81.501N.

Electrical and mechanical accessories

Rotary handles for Compact NSX DC

Extended rotary handle

Degree of protection IP55, IK08.

The extended rotary handle makes it possible to operate circuit breakers installed at the back of switchboards, from the switchboard front.

It maintains:

- visibility of and access to trip-unit settings
- suitability for isolation
- indication of the three positions O (OFF), I (ON) and tripped.

Mechanical door locking when device closed

A standard feature of the extended rotary handle is a locking function, built into the shaft, that disables door opening when the circuit breaker is in the ON or tripped positions.

Door locking can be temporarily disabled with a tool to open the door without opening the circuit breaker. This operation is not possible if the handle is locked by a padlock.

Voluntary disabling of mechanical door locking

A modification to the handle, that can be carried out on site, completely disables door locking, including when a padlock is installed on the handle. The modification is reversible.

When a number of extended rotary handles are installed on a door, this disabling function is the means to ensure door locking by a single device.

Device and door padlocking

Padlocking locks the circuit breaker handle and disables door opening:

- standard situation, in the OFF position, using 1 to 3 padlocks, shackle diameter 5 to 8 mm, not supplied
 - with a simple modification, in the ON and OFF positions. Locking in the ON position does not prevent free circuit breaker tripping if a fault occurs. In this case, the handle remains in the ON position after the circuit breaker tripping. Unlocking is required to go to the tripped then the OFF position.
- If the door controls were modified to voluntarily disable door locking, padlocking does not lock the door, but does disable handle operation of the device.

Device locking using a keylock inside the switchboard

It is possible to install a Ronis or Profalux keylock (optional) on the base of the rotary handle to lock the device in the OFF position or in either the ON or OFF positions.

Accessory for device operation with the door open

When the device is equipped with an extended rotary handle, a control accessory mounted on the shaft makes it possible to operate the device with the door open.

- The device can be padlocked in the OFF position.
- The accessory complies with UL508.

Early-make or early-break contacts (optional)

The extended rotary handle offers the same possibilities with early-make and/or early-break contacts as the standard rotary handle.

Parts of the extended rotary handles

- A unit that replaces the front cover of the circuit breaker (secured by screws).
 - An assembly (handle and front plate) on the door that is always secured in the same position, whether the circuit breaker is installed vertically or horizontally.
 - An extension shaft that must be adjusted to the distance. The min/max distance between the back of circuit breaker and door is:
 - 185...600 mm for Compact NSX100 to 250 DC
 - 209...600 mm for Compact NSX400/630/1200 DC.
- For withdrawable devices, the extended rotary handle is also available with a telescopic shaft to compensate for device disconnection. In this case, the min/max distances are:
- 248...600 mm for Compact NSX100 to 250 DC
 - 272...600 mm for Compact NSX400/630/1200 DC.

Manual source-changeover systems

An additional accessory interlocks two devices with rotary handles to create a source-changeover system. Closing of one device is possible only if the second is open.

This function is compatible with direct or extended rotary handles.

Up to three padlocks can be used to lock in the OFF or ON position.



Compact NSX DC with an extended rotary handle installed at the back of a switchboard, with the keylock option and key.



Electrical and mechanical accessories

Motor mechanism for Compact NSX DC



Compact NSX250 DC with motor mechanism.

A

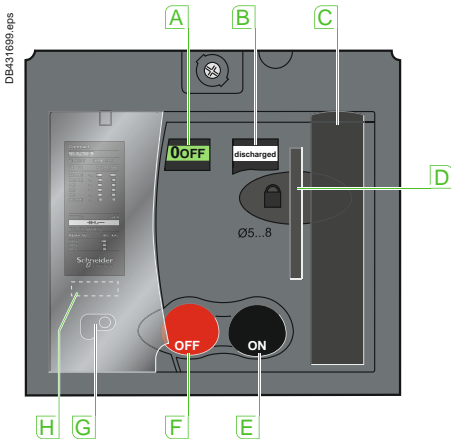

- A** Position indicator (positive contact indication)
- B** Spring status indicator (charged, discharged)
- C** Manual spring-charging lever
- D** Keylock device (optional)
Locking device (OFF position), using 1 to 3 padlocks, shackle diameter 5 to 8 mm, not supplied
- E** I (ON) pushbutton
- F** O (OFF) pushbutton
- G** Manual/auto mode selection switch. The position of this switch can be indicated remotely.
- H** Operation counter (Compact NSX400/630 DC).

When equipped with a **motor mechanism** module, Compact NSX DC circuit breakers feature very high mechanical endurance as well as easy and sure operation:

- all circuit breaker indications and information remain visible and accessible, including trip-unit settings and indications
- suitability for isolation is maintained and padlocking remains possible
- double insulation of the front face.

A specific motor mechanism is required for operation via the communication function^[1]. This **communicating motor mechanism** must be connected to the BSCM module to receive the opening and closing orders. Operation is identical to that of a standard motor mechanism.

Applications

- Local motor-driven operation, centralised operation, automatic distribution control.
- Normal/standby source changeover or switching to a replacement source to ensure availability or optimise energy costs.
- Load shedding and reconnection.
- Synchrocoupling.

Operation

The type of operation is selected using the manual/auto mode selection switch (7). A transparent, lead-seal cover controls access to the switch.

Automatic

When the switch is in the "auto" position, the ON/OFF (I/O) buttons and the charging lever on the mechanism are locked.

- Circuit breaker ON and OFF controlled by two impulse-type or maintained signals.
- Automatic spring charging following voluntary tripping (by MN or MX), with standard wiring.
- Mandatory manual reset following tripping due to an electrical fault.

Manual

When the switch is in the "manual" position, the ON/OFF (I/O) buttons may be used. A microswitch linked to the manual position can remote the information.

- Circuit breaker ON and OFF controlled by 2 pushbuttons I/O.
- Recharging of stored-energy system by pumping the lever 8 times.
- Padlocking in OFF position.

Installation and connections

All installation (fixed, plug-in/withdrawable) and connection possibilities are maintained.

Motor mechanism module connections are made behind its front cover to integrated terminals, for cables up to 2.5 mm².

Optional accessories

- Keylock for locking in OFF position.
- Operations counter for the Compact NSX400/630 DC, indicating the number of ON/OFF cycles. Must be installed on the front of the motor mechanism module.

Characteristics

Motor mechanism		MT100 to MT630	
Response time (ms)	opening	< 600	
	closing	< 80	
Operating frequency	cycles/minute max.	4	
Control voltage (V)	DC	24/30 - 48/60 - 110/130 - 250	
	AC 50/60 Hz	48 (50 Hz) - 110/130 - 220/240 - 380/440	
Consumption ^[1]	DC (W)	opening	≤ 500
		closing	≤ 500
	AC (VA)	opening	≤ 500
		closing	≤ 500

[1] For NSX100 to 250 DC, the inrush current is 2 In for 10 ms.

Electrical endurance

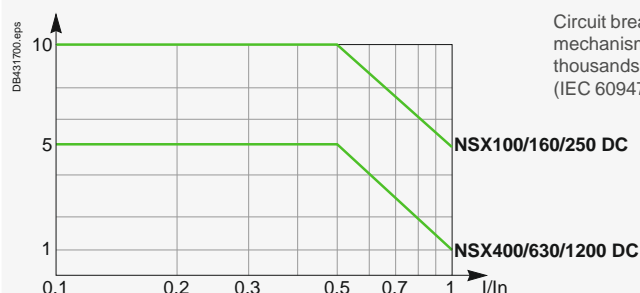

Circuit breaker + motor mechanism module, in thousands of operations (IEC 60947 2), at 440 V.

[1] NSX100-250 DC only.

Electrical and mechanical accessories

Remote tripping for Compact NSX DC

MX or MN voltage releases are used to trip the circuit breaker. They serve primarily for remote, emergency-off commands. It is advised to test the system every six months.

MN undervoltage release

The MN release opens the circuit breaker when its supply voltage drops to a value below 35 % of its rated voltage U_n . Undervoltage tripping, combined with an emergency-off button, provides fail-safe tripping. The MN release is continuously supplied, i.e. if supply is interrupted:
 ■ either voluntarily, by the emergency-off button,
 ■ or accidentally, through loss of power or faulty wiring, the release provokes opening of the circuit breaker.

Opening conditions

Circuit breaker tripping by an MN release meets the requirements of standard IEC 60947-2.

- Automatic opening of the circuit breaker is ensured when the continuous voltage supply to the release $U \leq 0.35 \times U_n$.
- If the supply voltage is between 0.35 and 0.7 U_n , opening is possible, but not guaranteed. Above 0.7 U_n , opening does not take place.

Closing conditions

If there is no supply to the MN release, it is impossible to close the circuit breaker, either manually or electrically. Closing is ensured when the voltage supply to the release $U \geq 0.85 \times U_n$. Below this threshold, closing is not guaranteed.

Characteristics

Power supply	V AC	50/60 Hz: 24 - 48 - 100/130 - 200/240
		50 Hz: 380/415 60 Hz: 208/277
Operating threshold	V DC	12 - 24 - 30 - 48 - 60 - 125 - 250
	Opening	0.35 to 0.7 U_n
	Closing	0.85 U_n
Operating range		0.85 to 1.1 U_n
Consumption (VA or W)		Pick-up: 10 - Hold: 5
Response time (ms)		50

Time-delay unit for an MN release

A time delay unit for the MN release eliminates the risk of nuisance tripping due to a transient voltage dip. For shorter micro-outages, a system of capacitors provides temporary supply to the MN at $U > 0.7$ to ensure non tripping. The correspondence between MN releases and time-delay units is shown below.

Power supply	Corresponding MN release
Unit with fixed delay 200 ms	
48 V AC	48 V DC
220 / 240 V AC	250 V DC
Unit with adjustable delay ≥ 200 ms	
48 - 60 V AC/DC	48 V DC
100 - 130 V AC/DC	125 V DC
220 - 250 V AC/DC	250 V DC

MX shunt release

The MX release opens the circuit breaker via an impulse-type (≥ 20 ms) or maintained order.

Opening conditions

When the MX release is supplied, it automatically opens the circuit breaker. Opening is ensured for a voltage $U \geq 0.7 \times U_n$.

Characteristics

Power supply	V AC	50/60 Hz: 24 - 48 - 100/130 - 200/240
		50 Hz: 380/415 60 Hz: 208/277
Operating range	V DC	12 - 24 - 30 - 48 - 60 - 125 - 250
		0.7 to 1.1 U_n
Consumption (VA or W)		Pick-up: 10
Response time (ms)		50

Circuit breaker control by MN or MX

When the circuit breaker has been tripped by an MN or MX release, it must be reset before it can be reclosed.

MN or MX tripping takes priority over manual closing.

In the presence of a standing trip order, closing of the contacts, even temporary, is not possible.

Connection using wires up to 1.5 mm² to integrated terminal blocks.



MX or MN voltage release.

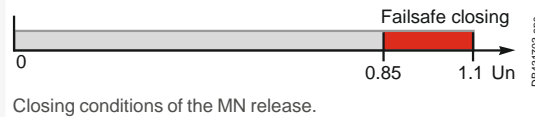
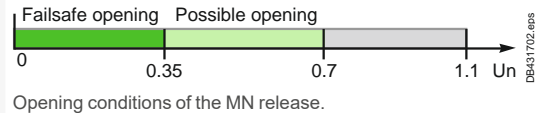

MN voltage release.

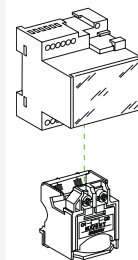

MN release with a time-delay unit.

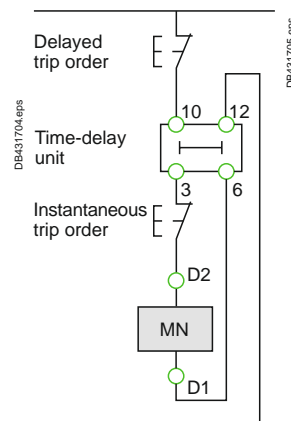

Wiring diagram for emergency-off function with MN + time-delay unit.

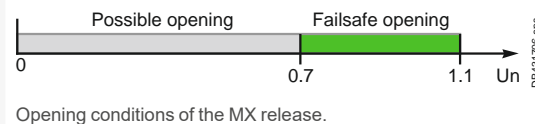

Opening conditions of the MX release.

Note: circuit breaker opening using an MN or MX release must be reserved for safety functions. This type of tripping increases wear on the opening mechanism. Repeated use reduces the mechanical endurance of the circuit breaker by 50 %.

Electrical and mechanical accessories

Locks for Compact NSX DC

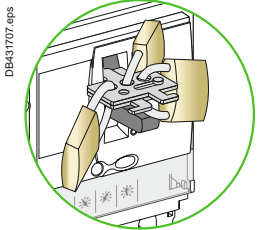

DB431707.eps

Toggle locking using padlocks and an accessory:
Removable device

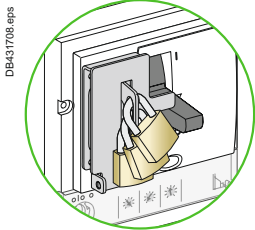

DB431708.eps

Fixed device attached to the case^[3]

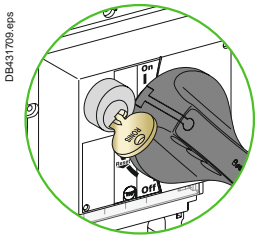

DB431709.eps

Rotary-handle locking using a keylock.

Locking in the OFF position guarantees isolation as per IEC 60947-2. Padlocking systems can receive up to three padlocks with shackle diameters ranging from 5 to 8 mm (padlocks not supplied). Certain locking systems require an additional accessory.

Control device	Function	Means	Required accessories
Toggle	Lock in OFF position	Padlock	Removable device
	Lock in OFF or ON position	Padlock	Fixed device
Direct rotary handle	Standard	Lock in ■ OFF position ■ OFF or ON position ^[1]	Padlock - Keylock Locking device + keylock
	MCC	Lock in ■ OFF position ■ OFF or ON position ^[1]	Padlock -
	CNOMO	Lock in ■ OFF position ■ OFF or ON position ^[1]	Padlock -
Extended rotary handle	Lock in ■ OFF position ■ OFF or ON position ^[1] with door opening prevented ^[2]	Padlock	-
	Lock in OFF position	Padlock	UL508 control accessory
	■ OFF or ON position ^[1] inside the switchboard	Keylock	Locking device + keylock
Motor mechanism	Lock in OFF position remote operation disabled	Padlock Keylock	- Locking device + keylock
	Withdrawable circuit breaker	Lock in ■ disconnected position	Padlock Keylock
■ connected position		Keylock	Locking device + keylock

[1] Following a simple modification of the mechanism.

[2] Unless door locking has been voluntarily disabled.

[3] Only for 3-4P.

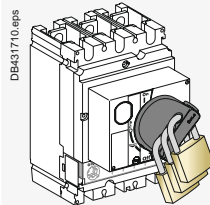

DB431710.eps

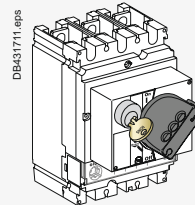

DB431711.eps

Rotary-handle locking using a padlock or a keylock.

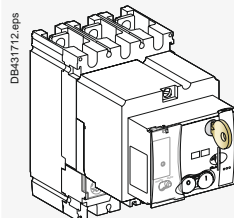

DB431712.eps

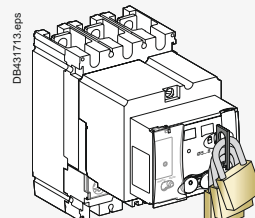

DB431713.eps

Motor mechanism locking using a padlock or a keylock.

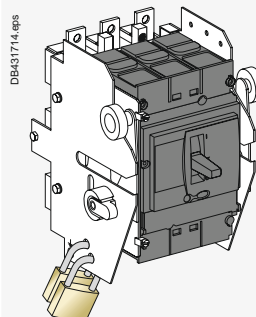

DB431714.eps

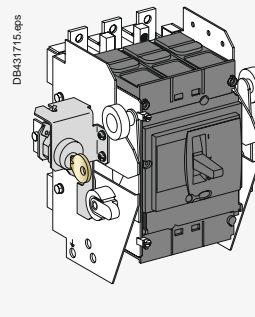

DB431715.eps

Chassis locking in the connected position.

Electrical and mechanical accessories

Sealing accessories for Compact NSX DC

Outgoing-circuit identification

Compact NSX100 to 630 DC can be equipped with label holders supplied in sets of ten (cat. no. LV429226). They are compatible with escutcheons.

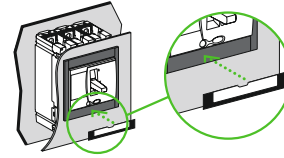

Identification accessories.

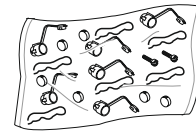

Sealing accessories.

Sealing accessories

Sealing accessories are available. Each bag of accessories contains all the parts required for the types of sealing indicated below.

A bag contains:

- 6 sealing accessories
- 6 lead seals
- 0.5 m of wire
- 2 screws.

Types of seals and corresponding functions

<p>Toggle control</p>	<p>DB431718.eps</p>	<p>DB431719.eps</p>		<p>DB431720.eps</p>
<p>Rotary handle</p>	<p>DB431721.eps</p>	<p>DB431722.eps</p>		<p>DB431723.eps</p>
<p>Motor mechanism</p>	<p>DB431724.eps</p>	<p>DB431725.eps</p>	<p>DB431726.eps</p>	<p>DB431727.eps</p>
<p>Types of seals</p>	<p>Front-cover fixing screw</p>	<p>Trip-unit transparent cover</p>	<p>Motor mechanism transparent cover</p>	<p>Terminal-shield fixing screw</p>
<p>Protected operations</p>	<ul style="list-style-type: none"> ■ front removal ■ access to auxiliaries ■ trip-unit removal. 	<ul style="list-style-type: none"> ■ modification of settings ■ access to test connector. 	<ul style="list-style-type: none"> ■ access to manual/auto mode selection switch: depending on its position, manual⁽¹⁾ or automatic operation is not possible. [1] In this case, local operation is not possible. 	<ul style="list-style-type: none"> ■ access to power connections (protection against direct contact).

DB431716.eps

DB431717.eps



Electrical and mechanical accessories

Escutcheons and protection collars for Compact NSX DC

Escutcheons are an optional feature mounted on the switchboard door. They increase the degree of protection to IP40, IK07. Protection collars maintain the degree of protection, whatever the position of the device (connected, disconnected).

A



IP30 escutcheon.



IP30 escutcheon with access to the trip unit.

IP30 or IP40 escutcheons for fixed devices

IP30

The three types are glued to the cut-out in the front door of the switchboard:

- escutcheon for all control types (toggle, rotary handle or motor mechanism):
 - without access to the trip unit
 - with access to the trip unit.

IP40

The four types, with a gasket, are screwed to the door cut-out:

- three escutcheons identical to the previous, but IP40
- a wide model for Vigi and ammeter modules that can be combined with the above.

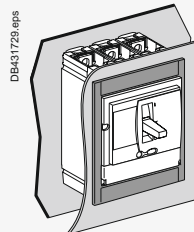
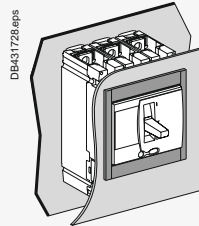

Escutcheon for toggle without and with access to the trip unit.

Electrical and mechanical accessories

Escutcheons and protection collars for Compact NSX DC

IP40 escutcheons for withdrawable devices

IP40 for withdrawable devices

The two types, with a gasket, are screwed to the door cut-out:

- for rotary handle or motor mechanism: standard IP40 escutcheon
- for toggle with extension: standard escutcheon + collar for withdrawal.

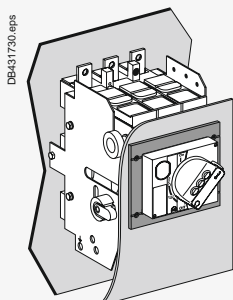

Standard escutcheon with rotary handle.

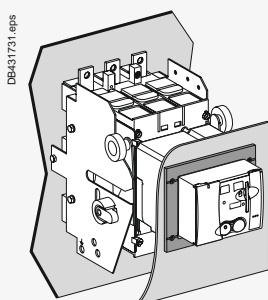

Standard escutcheon for motor mechanism.

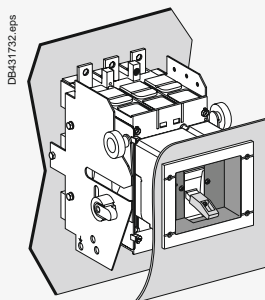

Standard escutcheon with collar for withdrawal, for toggle.

IP43 toggle cover

Available only for devices with toggles. Fits over toggle and front cover of the device.

- Mounted on the front of the circuit breaker.
- Degree of protection IP43, IK07.



Toggle cover.

Retrofit front covers

These replacement front covers make it possible to install NSX DC devices in existing switchboards containing NSX devices by installing the NSX-type retrofit covers on the NSX DC devices.

- NSX100 to 250 DC cover.
- NSX400/630 DC cover.



Escutcheon with collar for toggle.



Toggle cover.



NSX retrofit front cover.

PB103777-36.eps

PB103775-40.eps

PB103820_35.eps



Source-changeover systems

Presentation

A

P191615-50.eps



65597-117.eps



P10832-104.eps



Some installations use two supply sources to counter the temporary loss of the main supply.

A source-changeover system is required to safely switch between the two sources. The replacement source can be a generator set or another network.

Manual source-changeover system or MTSE (Manual Transfer Switching Equipment)

The simplest way to switch the load. It is controlled manually by an operator. The time required to switch from the S1 source to S2 source is variable.

System

2 or 3 mechanically interlocked circuit breakers or 2 switch-disconnectors.

Applications

Small commercial buildings and small and medium industrial activities where the need for continuity of service is significant but not a priority.

Automatic source-changeover system or ATSE (Automatic Transfer Switching Equipment)

An automatic controller may be added to a remote operated source-changeover system. It is possible to automatically control source transfer according to programmed (dedicated controllers) or programmable (PLC) operating modes. These solutions ensure optimum energy management.

The time required to switch from the S1 source to S2 source is fixed.

System

2 or 3 circuit breakers linked by an electrical interlocking system. A mechanical interlocking system protects also against incorrect manual operations, with an automatic control system (dedicated controllers).

Applications

Large infrastructures, industry, critical buildings & process where the continuity of service is a priority.

Remote source-changeover system or RTSE (Remote Transfer Switching Equipment)

In this case, no direct human intervention is required. The time required to switch from the S1 source to S2 source is fixed.

System

2 or 3 circuit breakers linked by an electrical interlocking system. A mechanical interlocking system protects also against incorrect manual operations. In this case is necessary to add a PLC controller not dedicated for source-changeover application.

Applications

Industry & Infrastructure where continuity of service requirements are meaningful but not a priority.

Source-changeover systems

Manual source-changeover systems

Interlocking of two or three toggle-controlled devices

Interlocking system

Two devices can be interlocked using this system. Two identical interlocking systems can be used to interlock three devices installed side by side.

Authorised positions:

- one device closed (ON), the others open (OFF)
- all devices open (OFF).

The system is locked using one or two padlocks (shackle diameter 5 to 8 mm).

This system can be expanded to more than three devices.

There are two interlocking-system models:

- one for Compact INS/INV
- one for Compact NSX100 to NSX250
- one for Compact NSX400 to NSX630.

Combinations of Normal and Replacement devices

All toggle-controlled fixed or plug-in Compact NSX100 to NSX630 circuit breakers and switch-disconnectors of the same frame size can be interlocked. The devices must be either all fixed or all plug-in versions.

Interlocking of two devices with rotary handles

Interlocking system

Interlocking involves padlocking the rotary handles on two devices which may be either circuit breakers or switch-disconnectors.

Authorised positions:

- one device closed (ON), the other open (OFF)
- both devices open (OFF).

The system is locked using up to three padlocks (shackle diameter 5 to 8 mm).

There are two interlocking-system models:

- one for Compact INS/INV
- one for Compact NSX100 to NSX250
- one for Compact NSX400 to NSX630.

Combinations of Normal and Replacement devices

All rotary-handle fixed or plug-in Compact NSX100 to NSX630 circuit breakers and switch-disconnectors of the same frame size can be interlocked. The devices must be either all fixed or all plug-in versions.

Interlocking of a number of devices using keylocks (captive keys)

Interlocking using keylocks is very simple and makes it possible to interlock two or more devices that are physically distant or that have very different characteristics, for example medium-voltage and low-voltage devices or a Compact NSX100 to NSX630 switch-disconnector.

Interlocking system

Each device is equipped with an identical keylock and the key is captive on the closed (ON) device. A single key is available for all devices. It is necessary to first open (OFF position) the device with the key before the key can be withdrawn and used to close another device.

A system of wall-mounted captive key boxes makes a large number of combinations possible between many devices.

Combinations of Normal and Replacement devices

All rotary-handle Compact NSX100 to NSX630 circuit breakers and switch-disconnectors can be interlocked between each other or with any other device equipped with the same type of keylock.

Interlocking of two devices on a base plate

Interlocking system

A base plate designed for two Compact NSX devices can be installed horizontally or vertically on a mounting rail. Interlocking is carried out on the base plate by a mechanism located behind the devices. In this way, access to the device controls and trip units is not blocked.

Combinations of Normal and Replacement devices

All rotary-handle and toggle-controlled Compact NSX100 to NSX630 circuit breakers and switch-disconnectors can be interlocked. Devices must be either all fixed or all plug-in versions, with or without earth-leakage protection or measurement modules. An adaptation kit is required to interlock:

- two plug-in devices
- a Compact NSX100 to NSX250 with an NSX400 to NSX630.

Connection to the downstream installation can be made easier using a coupling accessory (see next page).



Interlocking of two or three toggle-controlled devices.

PB113435.eps

A



Interlocking of two devices with rotary handles.

PB113418.eps



Interlocking with keylocks.

PB113528.eps



Interlocking on a base plate.

PB113417.eps

Circuit breaker characteristics

Compact NSX80 TM DC PV to NSX500 TM DC PV



Compact NSX200 TM DC PV.



Connection and insulation accessories.

A

Compact NSX DC PV circuit breaker

Number of poles

Electrical characteristics as per IEC 60947-2 and EN 60947-2

Rated current (A) (free air + no venting)	I_n	40 °C heatsink standard-IP4X
Altitude	m	2000
Rated insulation voltage (V)	U_i	
Rated impulse withstand voltage (kV)	U_{imp}	
Rated operational voltage (V)	U_e	DC

Type of circuit breaker

Ultimate breaking capacity (L/R 2 ms)	I_{cu} (kArms)	DC	1000 V (4P series)
Service breaking capacity	I_{cs}	% I_{cu}	
Suitability for isolation			

Selectivity category (Utilisation category)
Pollution degree

Durability

Endurance (C-O cycles)	mechanical	
	electrical (I_n)	1000 V

Protection

Overload/short-circuit protection thermal magnetic

Installation and connections

Control	manual	toggle
	motor mechanism	
Connections	fixed	front connection
		long rear connection
	plug-in (on base)	front connection
		rear connection
	withdrawable (on chassis)	front connection
		rear connection

Additional measurement, indication and control auxiliaries

Indication contacts	OF	auxiliary contact
	SD, SDE	trip, fault-trip
Voltage releases	MX, MN	shunt trip/undervoltage release

Installation

Accessories	crimp lugs / bare cable connector
	terminal extensions and spreaders
	escutcheons
	terminal shields and interphase barriers
	Din rail adapter

Dimensions and weight

Dimensions (mm) W x H x D (w/o series connection)	4P
Weight (kg)	fixed front connection 4P

[1] Double earth fault:

PV systems are either insulated from the earth or one pole is earthed through an overcurrent protection. In both set-ups, therefore, there can be a ground fault in which current leaks to the ground. If this fault is not cleared, it may spread to the healthy pole and give rise to a hazardous situation where fire could break out. Even though double insulation makes such an eventuality unlikely, it deserves full attention.

For the two following reasons the double fault situation shall be absolutely avoided: insulation monitoring devices or overcurrent protection in earthed system shall detect first fault and staff shall look after the first fault and clear it with no delay.

■ The fault level could be low (e.g. two insulation faults or a low short-circuit capability of the generator in weak sunlight) and below the tripping value of overcurrent protection (circuit breaker or fuses). However, a DC arc fault does not extinguish itself, even when the current is low. It could be a serious hazard, particularly for PV modules on buildings.

■ Circuit breakers and switches used in PV systems are designed to break the rated current or fault current with all poles at open-circuit maximum voltage ($U_{OC\ MAX}$). To break the current when $U_{OC\ MAX}$ is equal to 1000 V, four poles in series (two poles in series for each polarity) are required. In double earth fault situations, the circuit breaker or switches must break the current at full voltage with only two poles in series. Such switchgear is not designed for that purpose and could sustain irremediable damage if used to break the current in a double ground fault situation.

The ideal solution is to prevent double ground faults arising. Insulation monitoring devices or overcurrent protection in grounded systems detect the first fault. However, although the insulation fault monitoring system usually stops the inverter, the fault is still present. Staff must locate and clear it without delay. In large generators with sub-arrays protected by circuit breakers, it is highly advisable to disconnect each array when that first fault has been detected but not cleared within the next few hours.

Circuit breaker characteristics

Compact NSX80 TM DC PV to NSX500 TM DC PV



	NSX80 TM DC PV	NSX125 TM DC PV	NSX160 TM DC PV	NSX200 TM DC PV	NSX250 TM DC PV	NSX320 TM DC PV	NSX400 TM DC PV	NSX500 TM DC PV
	4	4	4	4	4	4	4	4
	80	125	160	200	250	320	400	500
	☉	☉	☉	☉	☉	☉	☉	☉
	1000	1000	1000	1000	1000	1000	1000	1000
	8	8	8	8	8	8	8	8
	1000	1000	1000	1000	1000	1000	1000	1000
	10 ^[1]	10 ^[1]	10 ^[1]	10 ^[1]	10 ^[1]	10 ^[1]	10 ^[1]	10 ^[1]
	50 %	50 %	50 %	50 %	100 %	100 %	100 %	100 %
	☉	☉	☉	☉	☉	☉	☉	☉
	A	A	A	A	A	A	A	A
	3	3	3	3	3	3	3	3
	10000	10000	10000	10000	5000	5000	5000	5000
	1500	1500	1000	1000	1000	1000	1000	1000
	☉	☉	☉	☉	☉	☉	☉	☉
	☉	☉	☉	☉	☉	☉	☉	☉
	☉	☉	☉	☉	☉	☉	☉	☉
	☉	☉	☉	☉	☉	☉	☉	☉
	-	-	-	-	-	-	-	-
	-	-	-	-	-	-	-	-
	-	-	-	-	-	-	-	-
	-	-	-	-	-	-	-	-
	☉	☉	☉	☉	☉	☉	☉	☉
	☉	☉	☉	☉	☉	☉	☉	☉
	☉	☉	☉	☉	☉	☉	☉	☉
	☉	☉	☉	☉	☉	☉	☉	☉
	☉	☉	☉	☉	☉	☉	☉	☉
	☉	☉	☉	☉	☉	☉	☉	☉
	☉	☉	☉	☉	-	-	-	-
	140 x 161 x 86	140 x 161 x 86	140 x 161 x 86	140 x 161 x 86	225 x 185 x 110	225 x 185 x 110	225 x 185 x 110	225 x 185 x 110
	2.8	2.8	2.8	2.8	8.1	8.1	8.1	8.1

Trip unit for Compact NSX DC PV non interchangeable ^[2]									
Type of trip unit	TM 80 DC PV	TM 125 DC PV	TM 160 DC PV	TM 200 DC PV	TM 250 DC PV	TM 320 DC PV	TM 400 DC PV	TM 500 DC PV	
Rating	In (A) at 40 °C								
	80	125	160	200	250	320	400	500	
Overload protection (thermal)									
Tripping threshold	Ir (A) at 40 °C								
	Adjustable 0.7 to 1 x In								
Protection against short-circuits (magnetic)									
Pick-up	Im (A)								
	Fixed 800 A	Fixed 1250 A		Adjustable 5 to 10 In					

[2] See tripping curves page E-14 and E-15.

Switch-disconnectors characteristics

Compact NSX100 NA DC PV to NSX500 NA DC PV

PB110638.eps



Compact NSX200 NA DC PV.

PB110647.eps



Compact NSX200 NA DC PV.

Compact NSX DC PV switch-disconnector

Number of poles

Electrical characteristics as per IEC 60947-3

Rated current (A) (free air + no venting)	I_n	40 °C
Altitude	m	2000
Rated insulation voltage (V)	U_i	
Rated impulse withstand voltage (U_{imp}) (kV)		
Rated operational voltage (V)	U_e	DC

Type of circuit breaker

Rated short circuit withstand current (kA rms)	I_{cw}/I_{cm}	$t = 1\text{ s}$
Rated conditionnal short-circuit current	I_q	kA
	with back-up fuse	A gPV
Rated conditionnal short-circuit current	I_q with circuit breaker	kA with MCCB

Utilization category

Suitability for isolation

Pollution degree

Durability

Endurance (C-O cycles)	mechanical	
	electrical (I_n)	1000 V

Installation and connections

Control	manual	toggle
		direct or extended rotary handle
	motor mechanism	
Connections	fixed	front connection
		long rear connection
	plug-in (on base)	front connection
		rear connection
	withdrawable (on chassis)	front connection
		rear connection

Additional measurement, indication and control auxiliaries

Indication contacts	OF	auxiliary contact
	SD, SDE	trip, fault-trip
Voltage releases	MX, MN	shunt trip/undervoltage release

Installation

Accessories	crimp lugs / bare cable connector
	terminal extensions and spreaders
	escutcheons
	terminal shields and interphase barriers
	Din rail adapter

Dimensions and weight

Dimensions (mm) W x H x D (w/o series connection)	4P
Weight (kg) (w/o series connection)	4P

[1] Double earth fault:

PV systems are either insulated from the earth or one pole is earthed through an overcurrent protection. In both set-ups, therefore, there can be a ground fault in which current leaks to the ground. If this fault is not cleared, it may spread to the healthy pole and give rise to a hazardous situation where fire could break out. Even though double insulation makes such an eventuality unlikely, it deserves full attention.

For the two following reasons the double fault situation shall be absolutely avoided: insulation monitoring devices or overcurrent protection in earthed system shall detect first fault and staff shall look after the first fault and clear it with no delay.

■ The fault level could be low (e.g. two insulation faults or a low short-circuit capability of the generator in weak sunlight) and below the tripping value of overcurrent protection (circuit breaker or fuses). However, a DC arc fault does not extinguish itself, even when the current is low. It could be a serious hazard, particularly for PV modules on buildings.

■ Circuit breakers and switches used in PV systems are designed to break the rated current or fault current with all poles at open-circuit maximum voltage ($U_{OC\text{MAX}}$). To break the current when $U_{OC\text{MAX}}$ is equal to 1000 V, four poles in series (two poles in series for each polarity) are required. In double earth fault situations, the circuit breaker or switches must break the current at full voltage with only two poles in series. Such switchgear is not designed for that purpose and could sustain irremediable damage if used to break the current in a double ground fault situation.

The ideal solution is to prevent double ground faults arising. Insulation monitoring devices or overcurrent protection in grounded systems detect the first fault. However, although the insulation fault monitoring system usually stops the inverter, the fault is still present. Staff must locate and clear it without delay. In large generators with sub-arrays protected by circuit breakers, it is highly advisable to disconnect each array when that first fault has been detected but not cleared within the next few hours.

Switch-disconnectors characteristics

Compact NSX100 NA DC PV to NSX500 NA DC PV

NSX100 NA DC PV	NSX160 NA DC PV	NSX200 NA DC PV	NSX400 NA DC PV	NSX500 NA DC PV
4	4	4	4	4
100 heatsink - IP4X ☉	160 heatsink - IP4X ☉	200 heatsink - IP4X ☉	400 heatsink - IP3X ☉	500 heatsink - IP3X ☉
1000 [1]	1000 [1]	1000 [1]	1000 [1]	1000 [1]
8	8	8	8	8
1000	1000	1000	1000	1000
2.5	2.5	2.5	6	6
10	10	10	10	10
100	160	200	400	500
10 NSX125 TM DC PV DC22-A ☉	10 NSX160-200 TM DC PV DC22-A ☉	10 NSX200 TM DC PV DC22-A ☉	- DC22-A ☉	- DC22-A ☉
3	3	3	3	3
10000	10000	10000	5000	5000
1500	1000	1000	1000	1000
☉	☉	☉	☉	☉
☉	☉	☉	☉	☉
☉	☉	☉	☉	☉
☉	☉	☉	☉	☉
☉	☉	☉	☉	☉
-	-	-	-	-
-	-	-	-	-
-	-	-	-	-
-	-	-	-	-
☉	☉	☉	☉	☉
☉	☉	☉	☉	☉
☉	☉	☉	☉	☉
■	☉	☉	☉	☉
■	☉	☉	☉	☉
■	☉	☉	☉	☉
■	☉	☉	☉	☉
■	☉	☉	-	-
140 x 161 x 86	140 x 161 x 86	140 x 161 x 86	185 x 255 x 110	185 x 255 x 110
2.8	2.8	2.8	8.1	8.1



Switch-disconnectors characteristics

Compact NSX630b NA DC PV to NSX1600 NA DC PV

PB112180_53.eps



Compact NSX1600 NA DC PV.

A

Compact NSX DC PV switch-disconnector

Number of poles

Electrical characteristics as per IEC 60947-3

Rated current (A) (free air + no venting)	I_n	40 °C
Altitude	m	2000
Rated insulation voltage (V)	U_i	
Rated impulse withstand voltage (kV)	U_{imp}	
Rated operational voltage (V)	U_e	DC

Type of circuit breaker

Rated short circuit withstand current (kA rms)	I_{cw}/I_{cm}	$t = 1 \text{ s}$
Rated conditionnal short-circuit current	I_q with back-up fuse	kA A gPV

Rated conditionnal short-circuit
current I_q with circuit breaker

Utilization category

Suitability for isolation

Pollution degree

Durability

Endurance (C-O cycles)	mechanical	
	electrical (I_n)	1000 V

Installation and connections

Control	manual	
	motor mechanism	
Connections	fixed	front connection
		rear connection

Additional measurement, indication and control auxiliaries

Indication contacts	OF	auxiliary contact
Voltage releases	MX, MN	shunt trip/undervoltage release

Installation

Accessories	terminal extensions
	escutcheons
	terminal shields and interphase barriers

Dimensions and weight

Dimensions (mm) W x H x D (w/o series connection)	4P
Weight (kg) (w/o series connection)	4P

[1] Double earth fault:

PV systems are either insulated from the earth or one pole is earthed through an overcurrent protection. In both set-ups, therefore, there can be a ground fault in which current leaks to the ground. If this fault is not cleared, it may spread to the healthy pole and give rise to a hazardous situation where fire could break out. Even though double insulation makes such an eventuality unlikely, it deserves full attention.

For the two following reasons the double fault situation shall be absolutely avoided: insulation monitoring devices or overcurrent protection in earthed system shall detect first fault and staff shall look after the first fault and clear it with no delay.

■ The fault level could be low (e.g. two insulation faults or a low short-circuit capability of the generator in weak sunlight) and below the tripping value of overcurrent protection (circuit breaker or fuses). However, a DC arc fault does not extinguish itself, even when the current is low. It could be a serious hazard, particularly for PV modules on buildings.

■ Circuit breakers and switches used in PV systems are designed to break the rated current or fault current with all poles at open-circuit maximum voltage ($U_{OC\text{MAX}}$). To break the current when $U_{OC\text{MAX}}$ is equal to 1000 V, four poles in series (two poles in series for each polarity) are required. In double earth fault situations, the circuit breaker or switches must break the current at full voltage with only two poles in series. Such switchgear is not designed for that purpose and could sustain irremediable damage if used to break the current in a double ground fault situation.

The ideal solution is to prevent double ground faults arising. Insulation monitoring devices or overcurrent protection in grounded systems detect the first fault. However, although the insulation fault monitoring system usually stops the inverter, the fault is still present. Staff must locate and clear it without delay. In large generators with sub-arrays protected by circuit breakers, it is highly advisable to disconnect each array when that first fault has been detected but not cleared within the next few hours.

Switch-disconnectors characteristics

Compact NSX630b NA DC PV to NSX1600 NA DC PV

	NSX630b NA DC PV	NSX800b NA DC PV	NSX1000 NA DC PV	NSX1250 NA DC PV	NSX1600 NA DC PV
	4	4	4	4	4
630 heatsink - IP2X	800 heatsink - IP2X	1000 heatsink - IP2X	1250 heatsink - IP2X	1500 heatsink - IP0	
1000 ^[1]	1000 ^[1]	1000 ^[1]	1000 ^[1]	1000 ^[1]	
8	8	8	8	8	
1000	1000	1000	1000	1000	
20	20	20	20	20	
10	10	10	10	10	
N/A	N/A	N/A	N/A	N/A	
10	10	10	10	10	
DC22-A	DC22-A	DC22-A	DC22-B	DC22-B	
3	3	3	3	3	
10000	10000	10000	10000	10000	
1000	500	500	100	100	
280 x 327 x 182	280 x 327 x 182	280 x 327x 182	280 x 327 x 182	280 x 327 x 182	
18	18	18	18	18	



Functions and characteristics

Accessories and auxiliaries

Overview of Compact NSX80 TM to NSX500 TM DC PV circuit breakers

DE431733.eps

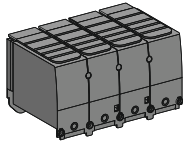

Terminal shields

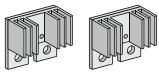

Heatsink

Communication [1]



NSX cord

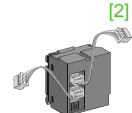

BSCM module

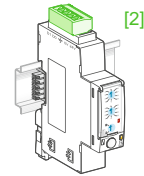

Modbus interface

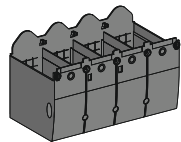

Terminal shields

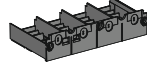

Short terminal shield

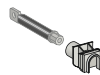

Rear connectors

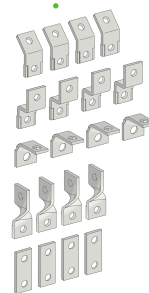

Terminal extensions

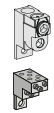

Cable connectors

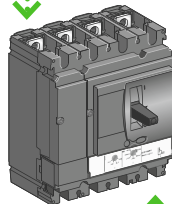

[1] See communication chapter.
[2] Compact NSX100-250 only.

Accessories and auxiliaries

Overview of Compact NSX100 NA to NSX500 NA DC PV switch-disconnectors

DE431734.eps

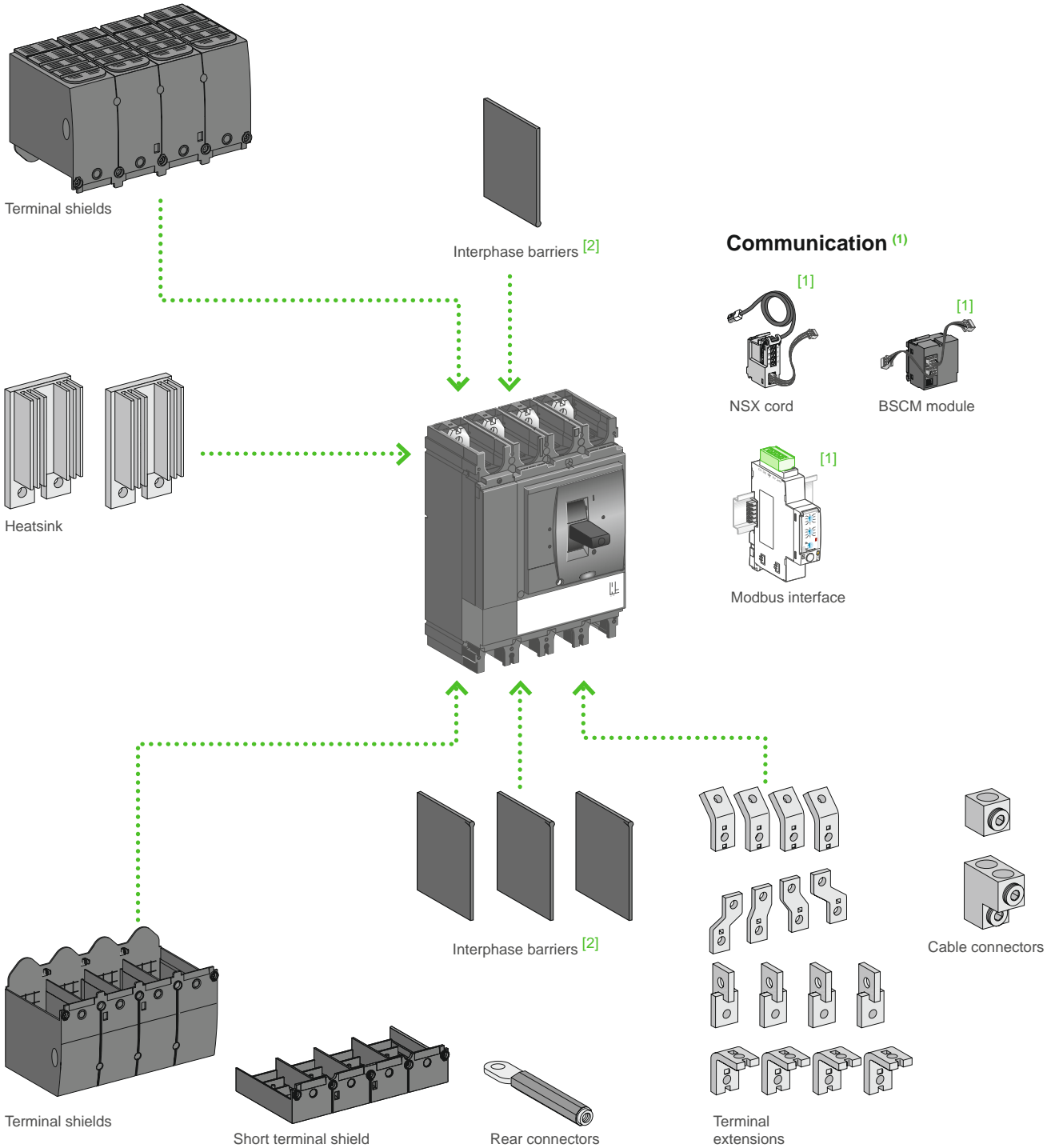

[1] See communication chapter.
[2] Only for switches.

Accessories and auxiliaries

Overview of Compact NSX630b NA to NSX1600 NA DC PV switch-disconnectors

DE431735.eps

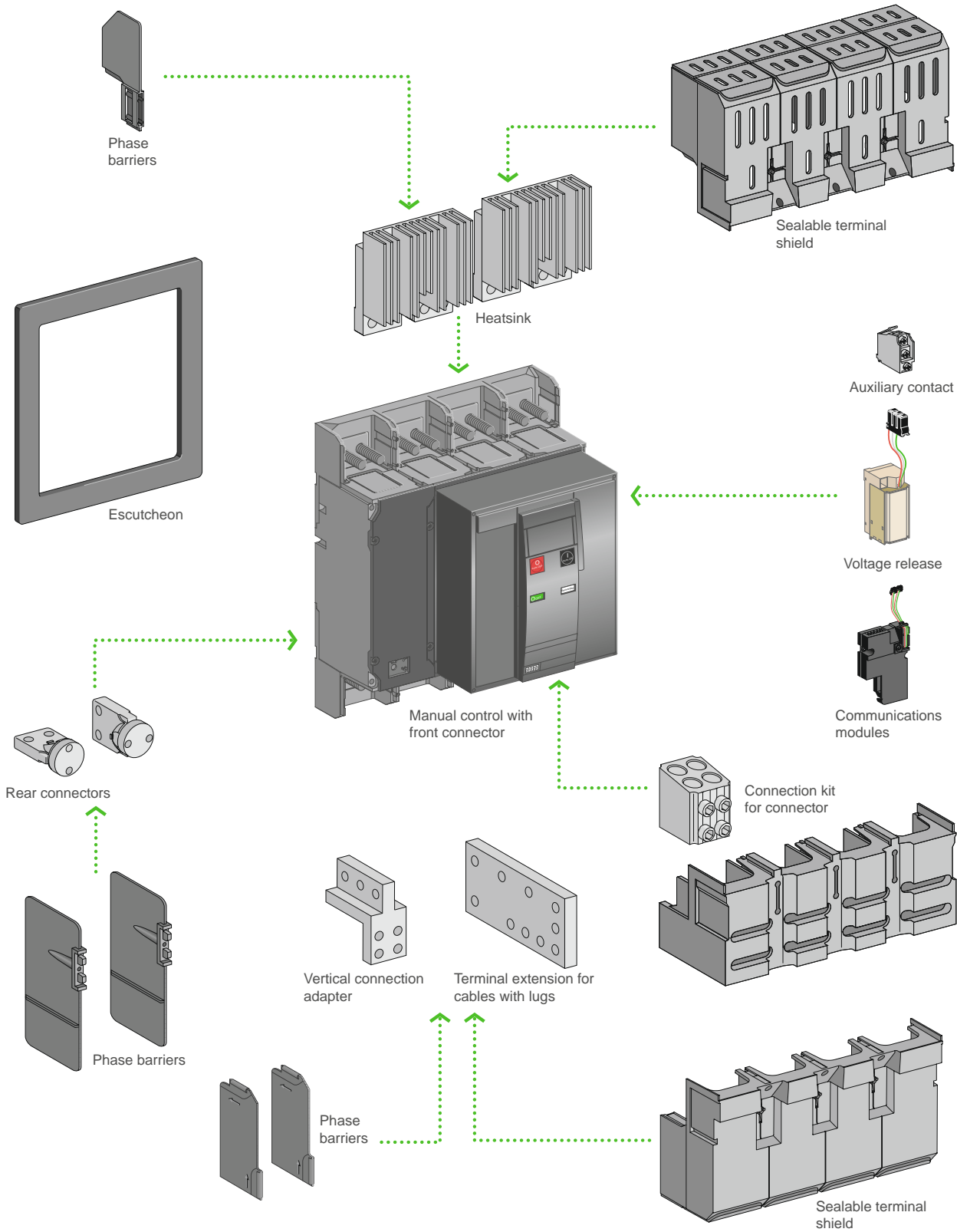

DB-417877-eps

Compact INS PV-1

Ui	600V
Uimp	8 kV
Ith	40A 60°
--- 600V DC Max 4PS	

	Ue (V)	Ie
DC21B	600	10A
DC21B	500	25A
DC21B	400	32A
DC21B	300	40A

IEC / EN 60947-3 

Schneider Electric



Compact INS PV-1.

No matter the size or scale of the project, Schneider Electric, has a photovoltaic solution to fit your needs. Fast ROI, high efficiency – it's all a part of our offer as the world leader in energy management.

The INS PV-1 is a direct current switch disconnecter dedicated to array isolation and control with Voc until 600 V DC.



Compact		INS80 PV
Number of poles		4 serial pole
Electrical characteristics		
Conventional thermal current (A)	Ith	
Conventional thermal current in enclosure (A)	Ithe	
Rated insulation level (DC V)	Ui	
Impulse-withstand voltage (kV)	Uimp	
Rated operational voltage (DC V)	Ue	
Rated operational voltage DC21B (V)		
Rated operational current (A)	Ie	Electrical DC
	DC21B	600
	DC21B	500
	DC21B	400
DC21B	300	
Rated duties		Uninterrupted duty
		Intermittent duty
		-
Short-circuit making capacity (kA peak)	Icm	Class 120 - 60 %
Short-time withstand current (A rms)	Icw	
Suitability for isolation		Yes
Durability (O-C cycles)		Mechanical
		Electrical DC
		600 V
		20000
Positive contact indication		1500
Visible break		Yes
Emergency-off switch disconnecter		-
Degree of pollution		Yes
		3

Functions and characteristics

Switch-disconnector selection

Compact INS40 to 160 DC

PB11402_30.eps



Compact INS40 to 80 switch-disconnector.

PB11403_30.eps



Compact INS40 to 80 emergency-off switch-disconnector.

PB11406_42.eps



Compact INS100 to 160 switch-disconnector.

PB11407_42.eps



Compact INS100 to 160 emergency-off switch-disconnector.

Compact INS switch-disconnectors

Number of poles

Electrical characteristics as defined by IEC 60947-1 / 60947-3 and EN 60947-1 / 60947-3

Conventional thermal current (A)	I_{th}	at 60 °C
Conventional thermal current in enclosure	I_{the}	at 60 °C
Rated insulation level (V)	U_i	AC 50/60 Hz
Impulse-withstand voltage (kV)	U_{imp}	
Rated operational voltage (V)	U_e	AC 50/60 Hz DC
Rated operational voltage AC20 and DC20 (V)		AC 50/60 Hz
Rated operational current (A)	I_e	Electrical DC 125 V (2P in series) 250 V (4P in series)
Rated duties		Uninterrupted duty Intermittent duty
Short-circuit making capacity (kA peak)	I_{cm}	Min. (switch-disconnector alone)
Short-time withstand current (A rms)	I_{cw}	1 s 3 s 20 s 30 s
Suitability for isolation		
Durability (O-C cycles)		Mechanical Electrical DC 250 V
Positive contact indication		
Visible break		
Emergency-off switch disconnector		
Degree of pollution		

Upstream protection

See the "Complementary technical information" in catalogue Compact INS/INV "LVPED213024EN".

Switch-disconnector selection

Compact INS40 to 160 DC

A

INS40		INS63		INS80		INS100		INS125		INS160	
3-4		3-4		3-4		3-4		3-4		3-4	
40		63		80		100		125		160	
40		63		80		100		125		160	
690		690		690		800		800		800	
8		8		8		8		8		8	
500		500		500		690		690		690	
250		250		250		250		250		250	
690		690		690		750		750		750	
DC22A	DC23A	DC22A	DC23A	DC22A	DC23A	DC22A	DC23A	DC22A	DC23A	DC22A	DC23A
40	40	63	63	80	80	100	100	125	125	160	160
40	40	63	63	80	80	100	100	125	125	160	160
⊙		⊙		⊙		⊙		⊙		⊙	
Class 120 - 60 %		Class 120 - 60 %		Class 120 - 60 %		Class 120 - 60 %		Class 120 - 60 %		Class 120 - 60 %	
15		15		15		20		20		20	
3000		3000		3000		5500		5500		5500	
1730		1730		1730		3175		3175		3175	
670		670		670		1230		1230		1230	
550		550		550		1000		1000		1000	
⊙		⊙		⊙		⊙		⊙		⊙	
20000		20000		20000		15000		15000		15000	
DC22A	DC23A	DC22A	DC23A	DC22A	DC23A	DC22A	DC23A	DC22A	DC23A	DC22A	DC23A
1500	1500	1500	1500	1500	1500	1500	1500	1500	1500	1500	1500
⊙		⊙		⊙		⊙		⊙		⊙	
-		-		-		-		-		-	
⊙		⊙		⊙		⊙		⊙		⊙	
3		3		3		3		3		3	
-		-		-		-		-		-	

Switch-disconnector selection

Compact INS40 to 160 DC

A

Compact INS switch-disconnectors

Installation

Fixed, front connection

Fixed, rear connection

On symmetrical rails

On a backplate

Connection

By cables To bare cable connectors

By cables with lugs

Directly to terminals

To spreaders

To vertical-connection adapters via cable-lug adapters

Flat-facing bars

Directly to terminals

To spreaders

Edgewise bars

To vertical-connection adapters

Indication and measurement auxiliaries

Auxiliary contacts

Voltage-presence indicator

Current-transformer module

Ammeter module

Control, locking and interlocking

Control

Direct front rotary handle

Extended front rotary handle

Direct lateral rotary handle

Extended lateral rotary handle

Locking

By keylock

By padlocks

Interlocking

By keylock

Mechanical

Complete source-changeover assembly

Operating torque (Nm) (typical value for 3-4 poles with front handle)

Installation and connection accessories

Bare cable connectors

Rear connectors

Terminal extensions

Spreaders

One-piece spreader

Terminal shrouds

Terminal shields

Interphase-barrier

Front panel escutcheons

Coupling accessories

Tightening torque for electrical connections (Nm)

Dimensions and weights

Overall dimensions H x W x D (mm)

3 poles

4 poles

Approximate weight (kg)

3 poles

4 poles

Enclosure dimensions for lthe

H x W x D (mm)

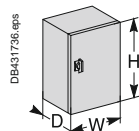

Switch-disconnector selection

Compact INS250-100 to 630 DC

PB111440_L52.eps



Compact INS250 switch-disconnector.

PB111441_L47.eps



Compact INS250 emergency-off switch-disconnector.

PB111482_L48.eps



Compact INS630 switch-disconnector.

PB111483_L48.eps



Compact INS630 emergency-off switch-disconnector.

Compact INS switch-disconnectors

Number of poles

Electrical characteristics as defined by IEC 60947-1 / 60947-3 and EN 60947-1 / 60947-3

Conventional thermal current (A)	I_{th}	at 60 °C
Conventional thermal current in enclosure	I_{the}	at 60 °C
Rated insulation level (V)	U_i	AC 50/60 Hz
Impulse-withstand voltage (kV)	U_{imp}	
Rated operational voltage (V)	U_e	AC 50/60 Hz DC
Rated operational voltage AC20 and DC20 (V)		AC 50/60 Hz
Rated operational current (A)	I_e	Electrical DC 125 V (2P in series) 250 V (4P in series)
Rated duties		Uninterrupted duty Intermittent duty
Short-circuit making capacity (kA peak)	I_{cm}	Min. (switch-disconnector alone)
Short-time withstand current (A rms)	I_{cw}	1 s 3 s 20 s 30 s
Suitability for isolation		
Durability (O-C cycles)		Mechanical Electrical DC 250 V

Positive contact indication

Visible break

Emergency-off switch disconnector

Degree of pollution

Upstream protection

See the "Complementary technical information" in catalogue Compact INS/INV "LVPED213024EN".

[1] Suitable for 480 V NEMA.

[2] 550 A (DC).

Switch-disconnector selection

Compact INS250-100 to 630 DC

INS250-100		INS250-160		INS250-200		INS250		INS320		INS400		INS500		INS630			
3-4		3-4		3-4		3-4		3-4		3-4		3-4		3-4			
100		160		200		250		320		400		500		630			
100		160		200		250		320		400		500		630 (2)			
800		800		800		800		800		800		800		800			
8		8		8		8		8		8		8		8			
690		690		690		690		690		690		690		690			
250		250		250		250		250		250		250		250			
750		750		750		750		750		750		750		750			
DC22A	DC23A	DC22A	DC23A	DC22A	DC23A	DC22A	DC23A	DC22A	DC23A	DC22A	DC23A	DC22A	DC23A	DC22A	DC23A	DC23B	
100	100	160	160	200	200	250	250	320	320	400	400	500	500	550	550	630	
100	100	160	160	200	200	250	250	320	320	400	400	500	500	550	550	630	
⊙		⊙		⊙		⊙		⊙		⊙		⊙		⊙		⊙	
Class 120 - 60 % 30		Class 120 - 60 % 30		Class 120 - 60 % 30		Class 120 - 60 % 30		Class 120 - 60 % 50		Class 120 - 60 % 50		Class 120 - 60 % 50		Class 120 - 60 % 50		Class 120 - 60 % 50	
8500		8500		8500		8500		20000		20000		20000		20000		20000	
4900		4900		4900		4900		11500		11500		11500		11500		11500	
2200		2200		2200		2200		4900		4900		4900		4900		4900	
1800		1800		1800		1800		4000		4000		4000		4000		4000	
⊙		⊙		⊙		⊙		⊙		⊙		⊙		⊙		⊙	
15000		15000		15000		15000		10000		10000		10000		10000		10000	
DC22A	DC23A	DC22A	DC23A	DC22A	DC23A	DC22A	DC23A	DC23A	DC23B	DC23A	DC23B	DC23A	DC23B	DC23A	DC23B		
1500	1500	1500	1500	1500	1500	1500	1500	1000	-	1000	-	1000	-	1000	200		
⊙		⊙		⊙		⊙		⊙		⊙		⊙		⊙		⊙	
-		-		-		-		-		-		-		-		-	
⊙		⊙		⊙		⊙		⊙		⊙		⊙		⊙		⊙	
3		3		3		3		3		3		3		3		3	
-		-		-		-		-		-		-		-		-	



Switch-disconnector selection

Compact INS250-100 to 630 DC



Compact INS switch-disconnectors

Installation

Fixed, front connection

Fixed, rear connection

On symmetrical rails

On a backplate

Connection

By cables To bare cable connectors

By cables with lugs Directly to terminals

To spreaders

To vertical-connection adapters via cable-lug adapters

Flat-facing bars Directly to terminals

To spreaders

Edgewise bars To vertical-connection adapters

Indication and measurement auxiliaries

Auxiliary contacts

Voltage-presence indicator

Current-transformer module

Ammeter module

Control, locking and interlocking

Control Direct front rotary handle

Extended front rotary handle

Direct lateral rotary handle

Extended lateral rotary handle

Locking By keylock

By padlocks

Interlocking By keylock

Mechanical

Complete source-changeover assembly

Operating torque (Nm) (typical value for 3-4 poles with front handle)

Installation and connection accessories

Bare cable connectors

Rear connectors

Terminal extensions

Spreaders

One-piece spreader

Terminal shrouds

Terminal shields

Interphase-barrier

Front panel escutcheons

Coupling accessories

Tightening torque for electrical connections (Nm)

Dimensions and weights

Overall dimensions H x W x D (mm) 3 poles

4 poles

Approximate weight (kg) 3 poles

4 poles

Enclosure dimensions for Ithe

H x W x D (mm)

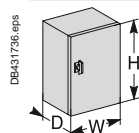

Switch-disconnector selection

Compact INS630b to 2500 DC

A



PB111510_45.eps

Compact INS1600 switch-disconnector.

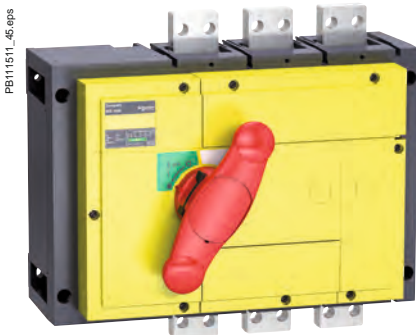

PB111511_46.eps

Compact INS1600 emergency-off switch-disconnector.



PB111518_72.eps

Compact INS2500 switch-disconnector.

Compact INS switch-disconnectors

Number of poles

Electrical characteristics as defined by IEC 60947-1 / 60947-3 and EN 60947-1 / 60947-3

Conventional thermal current (A)	I_{th}	at 60 °C
Conventional thermal current in enclosure	I_{the}	at 60 °C
Rated insulation level (V)	U_i	AC 50/60 Hz
Impulse-withstand voltage (kV)	U_{imp}	
Rated operational voltage (V)	U_e	AC 50/60 Hz DC
Rated operational voltage AC20 and DC20 (V)		AC 50/60 Hz
Rated operational current (A)	I_e	Electrical DC
		125 V (2P in series)
		250 V (4P in series)

Rated duties		Uninterrupted duty
		Intermittent duty
Short-circuit making capacity (kA peak)	I_{cm}	Min. (switch-disconnector alone)
Short-time withstand current (kA rms)	I_{cw}	0.5 s
		0.8 s
		1 s
		3 s
		20 s
		30 s

Suitability for isolation		
Durability (O-C cycles)		Mechanical
		Electrical DC
		125 V (2P)
		250 V (4P)

Positive contact indication		
Visible break		
Emergency-off switch disconnector		
Degree of pollution		

Upstream protection

See the "Complementary technical information" catalogue Compact INS/INV "LVPED213024EN".

[1] Suitable for 480 V NEMA.

[2] For vertical connection busbars only. For horizontal connection busbars, see derating charts in "Installation recommendations" in catalogue Compact INS/INV "LVPED213024EN".

Switch-disconnector selection

Compact INS630b to 2500 DC

INS630b			INS800			INS1000			INS1250			INS1600			INS2000			INS2500		
3-4			3-4			3-4			3-4			3-4			3-4			3-4		
630			800			1000			1250			1600 ⁽²⁾			2000			2500		
630			800			1000			1250			1600 ⁽²⁾			2000			2500		
1000			1000			1000			1000			1000			1000			1000		
12			12			12			12			12			12			12		
690			690			690			690			690			690			690		
250			250			250			250			250			250			250		
800			800			800			800			800			800			800		
DC21A	DC22A	DC23A	DC21A	DC22A	DC23A	DC21A	DC22A	DC23A	DC21A	DC22A	DC23A	DC21A	DC22A	DC23A	DC21B	DC22B	DC23B	DC21B	DC22B	DC23B
630/2	630/2	630/2	800/2	800/2	800/2	1000/2	1000/2	1000/2	1250/2	1250/2	1250/2	1600/2	1600/2	1600/2	2000/2	2000/2	-	2500/2	2500/2	-
630/4	630/4	630/4	800/4	800/4	800/4	1000/4	1000/4	1000/4	1250/4	1250/4	1250/4	1600/4	1600/4	1600/4	2000/4	2000/4	-	2500/4	2500/4	-
●			●			●			●			●			●			●		
Class 120 - 60 %			Class 120 - 60 %			Class 120 - 60 %			Class 120 - 60 %			Class 120 - 60 %			Class 120 - 60 %			Class 120 - 60 %		
75			75			75			75			75			105			105		
50			50			50			50			50			50			50		
42			42			42			42			42			50			50		
35			35			35			35			35			50			50		
20			20			20			20			20			30			30		
10			10			10			10			10			13			13		
8			8			8			8			8			11			11		
●			●			●			●			●			●			●		
5000			3000			3000			3000			3000			3000			3000		
DC21A	DC22A	DC23A	DC21A	DC22A	DC23A	DC21A	DC22A	DC23A	DC21A	DC22A	DC23A	DC21A	DC22A	DC23B	DC21B	DC22B	DC23B	DC21B	DC22B	DC23B
1000	1000	1000	500	500	500	500	500	500	500	500	500	500	500	500	100	100	-	100	100	-
1000	1000	1000	500	500	500	500	500	500	500	500	500	500	500	500	100	100	-	100	100	-
●			●			●			●			●			●			●		
-			-			-			-			-			-			-		
●			●			●			●			●			-			-		
3			3			3			3			3			3			3		
-			-			-			-			-			-			-		



Switch-disconnector selection

Compact INS630b to 2500 DC

A

Compact INS switch-disconnectors

Installation

Fixed, front connection

Fixed, rear connection

On symmetrical rails

On a backplate

Connection

By cables	To bare cable connectors
By cables with lugs	Directly to terminals
	To spreaders
	To vertical-connection adapters via cable-lug adapters
Flat-facing bars	Directly to terminals
	To spreaders
Edgewise bars	To vertical-connection adapters

Indication and measurement auxiliaries

Auxiliary contacts

Voltage-presence indicator

Current-transformer module

Ammeter module

Control, locking and interlocking

Control	Direct front rotary handle
	Extended front rotary handle
	Direct lateral rotary handle
	Extended lateral rotary handle
Locking	By keylock
	By padlocks
Interlocking	By keylock
	Mechanical

Complete source-changeover assembly

Operating torque (Nm) (typical value for 3-4 poles with front handle)

Installation and connection accessories

Bare cable connectors

Rear connectors

Terminal extensions

Spreaders

One-piece spreader

Terminal shrouds

Terminal shields

Interphase-barrier

Front panel escutcheons

Coupling accessories

Tightening torque for electrical connections (Nm)

Dimensions and weights

Overall dimensions H x W x D (mm)	3 poles
	4 poles
Approximate weight (kg)	3 poles
	4 poles

Enclosure dimensions for Ithe

H x W x D (mm)

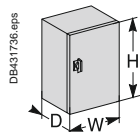

Switch-disconnector selection

Compact INS630b to 2500 DC

	INS630b	INS800	INS1000	INS1250	INS1600	INS2000	INS2500
	⊙	⊙	⊙	⊙	⊙	⊙	⊙
	⊙	⊙	⊙	⊙	⊙	⊙	⊙
	-	-	-	-	-	-	-
	⊙	⊙	⊙	⊙	⊙	⊙	⊙
	-	-	-	-	-	-	-
	-	-	-	-	-	⊙	⊙
	⊙	⊙	⊙	⊙	⊙	-	-
	⊙	⊙	⊙	⊙	⊙	⊙	⊙
	⊙	⊙	⊙	⊙	⊙	-	-
	⊙	⊙	⊙	⊙	⊙	-	-
	⊙	⊙	⊙	⊙	⊙	⊙	⊙
	-	-	-	-	-	-	-
	-	-	-	-	-	-	-
	-	-	-	-	-	-	-
	⊙	⊙	⊙	⊙	⊙	⊙	⊙
	⊙	⊙	⊙	⊙	⊙	⊙	⊙
	-	-	-	-	-	-	-
	-	-	-	-	-	-	-
	⊙	⊙	⊙	⊙	⊙	⊙	⊙
	⊙	⊙	⊙	⊙	⊙	⊙	⊙
	⊙	⊙	⊙	⊙	⊙	⊙	⊙
	-	-	-	-	-	-	-
	-	-	-	-	-	-	-
	30	30	30	30	30	60	60
	-	-	-	-	-	-	-
	-	-	-	-	-	-	-
	⊙	⊙	⊙	⊙	⊙	⊙	⊙
	⊙	⊙	⊙	⊙	⊙	⊙	⊙
	-	-	-	-	-	-	-
	-	-	-	-	-	-	-
	⊙	⊙	⊙	⊙	⊙	⊙	⊙
	⊙	⊙	⊙	⊙	⊙	⊙	⊙
	⊙	⊙	⊙	⊙	⊙	⊙	⊙
	-	-	-	-	-	-	-
	50	50	50	50	50	50	50
	300 x 340 x 146.5	300 x 340 x 146.5	300 x 340 x 146.5	300 x 340 x 146.5	300 x 340 x 146.5	440 x 347.5 x 227.5	440 x 347.5 x 227.5
	300 x 410 x 146.5	300 x 410 x 146.5	300 x 410 x 146.5	300 x 410 x 146.5	300 x 410 x 146.5	440 x 462.5 x 227.5	440 x 462.5 x 227.5
	14	14	14	14	14	35	35
	18	18	18	18	18	45	45
	-	-	-	-	-	-	-

A

Switch-disconnector selection

Compact INV100 to 630 DC

A



PB111442_02.eps

Compact INV250 switch-disconnector.



PB111443_47.eps

Compact INV250 emergency-off switch-disconnector.



PB111464_L49.eps

Compact INV630 switch-disconnector.

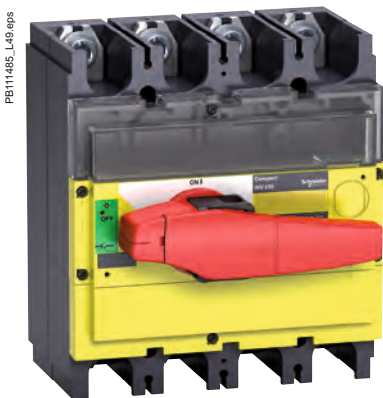

PB111485_L49.eps

Compact INV630 emergency-off switch-disconnector.

Compact INV switch-disconnectors

Number of poles

Electrical characteristics as defined by IEC 60947-1 / 60947-3 and EN 60947-1 / 60947-3

Conventional thermal current (A)	I_{th}	at 60 °C
Conventional thermal current in enclosure	I_{the}	at 60 °C
Rated insulation level (V)	U_i	AC 50/60 Hz
Impulse-withstand voltage (kV)	U_{imp}	
Rated operational voltage (V)	U_e	AC 50/60 Hz DC
Rated operational voltage AC20 and DC20 (V)		AC 50/60 Hz
Rated operational current (A)	I_e	Electrical DC 125 V (2P in series) 250 V (4P in series)

Rated duties	Uninterrupted duty
	Intermittent duty
Short-circuit making capacity (kA peak)	I_{cm} Min. (switch-disconnector alone)
Short-time withstand current (A rms)	I_{cw} 1 s
	3 s
	20 s
	30 s

Suitability for isolation	
Durability (O-C cycles)	Mechanical
	Electrical DC 250 V

Positive contact indication	
Visible break	
Emergency-off switch disconnector	

Degree of pollution	
---------------------	--

Upstream protection

See the "Complementary technical information" in catalogue Compact INS/INV "LVPED213024EN".

[1] Suitable for 480 V NEMA.

[2] 550 A (DC).

Functions and characteristics

Switch-disconnector selection

Compact INV100 to 630 DC

A

INV100			INV160			INV200			INV250			INV320			INV400			INV500			INV630					
3-4			3-4			3-4			3-4			3-4			3-4			3-4			3-4					
100			160			200			250			320			400			500			630					
100			160			200			250			320			400			500			630 ⁽²⁾					
800			800			800			800			800			800			800			800					
8			8			8			8			8			8			8			8					
690			690			690			690			690			690			690			690					
250			250			250			250			250			250			250			250					
750			750			750			750			750			750			750			750					
DC21A	DC22A	DC23B	DC21A	DC22A	DC23B	DC21A	DC22A	DC23B	DC21A	DC22A	DC23B	DC21A	DC22A	DC23A	DC21A	DC22A	DC23A	DC21A	DC22A	DC23A	DC21A	DC22A	DC23A	DC21A	DC22A	DC23A/DC23B
100	100	100	160	160	160	200	200	200	250	250	250	320	320	320	400	400	400	500	500	500	550	550	550	550	550	550/630
100	100	100	160	160	160	200	200	200	250	250	250	320	320	320	400	400	400	500	500	500	550	550	550	550	550	550/630
⊙			⊙			⊙			⊙			⊙			⊙			⊙			⊙			⊙		
Class 120 - 60 %			Class 120 - 60 %			Class 120 - 60 %			Class 120 - 60 %			Class 120 - 60 %			Class 120 - 60 %			Class 120 - 60 %			Class 120 - 60 %					
30			30			30			30			50			50			50			50					
8500			8500			8500			8500			20000			20000			20000			20000					
4900			4900			4900			4900			11500			11500			11500			11500					
2200			2200			2200			2200			4900			4900			4900			4900					
1800			1800			1800			1800			4000			4000			4000			4000					
⊙			⊙			⊙			⊙			⊙			⊙			⊙			⊙					
15000			15000			15000			15000			10000			10000			10000			10000					
DC22A	DC23A		DC22A	DC23A		DC22A	DC23A		DC22A	DC23A		DC21A	DC22A	DC23A	DC21A	DC22A	DC23A	DC21A	DC22A	DC23A	DC21A	DC22A	DC23A	DC21A	DC22A	DC23A/DC23B
1500	1500		1500	1500		1500	1500		1500	1500		1000	1000	1000	1000	1000	1000	1000	1000	1000	1000	1000	1000	1000	1000	1000/200
⊙			⊙			⊙			⊙			⊙			⊙			⊙			⊙			⊙		
⊙			⊙			⊙			⊙			⊙			⊙			⊙			⊙			⊙		
⊙			⊙			⊙			⊙			⊙			⊙			⊙			⊙			⊙		
3			3			3			3			3			3			3			3					
-			-			-			-			-			-			-			-					

Switch-disconnector selection

Compact INV100 to 630 DC



Compact INV switch-disconnectors

Installation

Fixed, front connection

Fixed, rear connection

On symmetrical rails

On a backplate

Connection

By cables To bare cable connectors

By cables with lugs Directly to terminals

To spreaders

To vertical-connection adapters via cable-lug adapters

Flat-facing bars Directly to terminals

To spreaders

Edgewise bars To vertical-connection adapters

Indication and measurement auxiliaries

Auxiliary contacts

Voltage-presence indicator

Current-transformer module

Ammeter module

Control, locking and interlocking

Control Direct front rotary handle

Extended front rotary handle

Direct lateral rotary handle

Extended lateral rotary handle

Locking By keylock

By padlocks

Interlocking By keylock

Mechanical

Complete source-changeover assembly

Operating torque (Nm) (typical value for 3-4 poles with front handle)

Installation and connection accessories

Bare cable connectors

Rear connectors

Terminal extensions

Spreaders

One-piece spreader

Terminal shrouds

Terminal shields

Interphase-barrier

Front panel escutcheons

Coupling accessories

Tightening torque for electrical connections (Nm)

Dimensions and weights

Overall dimensions H x W x D (mm)

3 poles

4 poles

Approximate weight (kg)

3 poles

4 poles

Enclosure dimensions for lthe

H x W x D (mm)

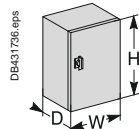

Switch-disconnector selection

Compact INV100 to 630 DC

A

	INV100	INV160	INV200	INV250	INV320	INV400	INV500	INV630
	⊙	⊙	⊙	⊙	⊙	⊙	⊙	⊙
	⊙	⊙	⊙	⊙	⊙	⊙	⊙	⊙
	-	-	-	-	-	-	-	-
	⊙	⊙	⊙	⊙	⊙	⊙	⊙	⊙
	⊙	⊙	⊙	⊙	⊙	⊙	⊙	⊙
	⊙	⊙	⊙	⊙	⊙	⊙	⊙	⊙
	-	-	-	-	-	-	-	-
	⊙	⊙	⊙	⊙	⊙	⊙	⊙	⊙
	⊙	⊙	⊙	⊙	⊙	⊙	⊙	⊙
	-	-	-	-	⊙	⊙	⊙	⊙
	⊙	⊙	⊙	⊙	⊙	⊙	⊙	⊙
	⊙	⊙	⊙	⊙	⊙	⊙	⊙	⊙
	⊙	⊙	⊙	⊙	⊙	⊙	⊙	⊙
	-	-	-	-	-	-	-	-
	5 < Nm < 6.2	5 < Nm < 6.2	5 < Nm < 6.2	5 < Nm < 6.2	13.5 < Nm < 16.5	13.5 < Nm < 16.5	13.5 < Nm < 16.5	13.5 < Nm < 16.5
	⊙	⊙	⊙	⊙	⊙	⊙	⊙	⊙
	⊙	⊙	⊙	⊙	⊙	⊙	⊙	⊙
	⊙	⊙	⊙	⊙	⊙	⊙	⊙	⊙
	⊙	⊙	⊙	⊙	⊙	⊙	⊙	⊙
	⊙	⊙	⊙	⊙	⊙	⊙	⊙	⊙
	⊙	⊙	⊙	⊙	⊙	⊙	⊙	⊙
	-	-	-	-	-	-	-	-
	⊙	⊙	⊙	⊙	⊙	⊙	⊙	⊙
	⊙	⊙	⊙	⊙	⊙	⊙	⊙	⊙
	⊙	⊙	⊙	⊙	⊙	⊙	⊙	⊙
	⊙	⊙	⊙	⊙	⊙	⊙	⊙	⊙
	15	15	15	15	50	50	50	50
	136 x 140 x 96	136 x 140 x 96	136 x 140 x 96	136 x 140 x 96	205 x 185 x 130	205 x 185 x 130	205 x 185 x 130	205 x 185 x 130
	136 x 140 x 96	136 x 140 x 96	136 x 140 x 96	136 x 140 x 96	205 x 185 x 130	205 x 185 x 130	205 x 185 x 130	205 x 185 x 130
	2	2	2	2	4.6	4.6	4.6	4.6
	2.2	2.2	2.2	2.2	4.9	4.9	4.9	4.9
	400 x 300 x 200	400 x 300 x 200	400 x 300 x 200	400 x 300 x 200	600 x 400 x 200	600 x 400 x 200	600 x 400 x 200	600 x 400 x 200

Functions and characteristics

Switch-disconnector selection

Compact INV630b to 2500 DC

PB11512_45.eps



Compact INV1600 switch-disconnector.

PB11513_45.eps



Compact INV1600 emergency-off switch-disconnector.

PB11519_L62.eps



Compact INV2500 switch-disconnector.

Compact INV switch-disconnectors

Number of poles

Electrical characteristics as defined by IEC 60947-1 / 60947-3 and EN 60947-1 / 60947-3

Conventional thermal current (A)	I_{th}	at 60 °C
Conventional thermal current in enclosure	I_{the}	at 60 °C
Rated insulation level (V)	U_i	AC 50/60 Hz
Impulse-withstand voltage (kV)	U_{imp}	
Rated operational voltage (V)	U_e	AC 50/60 Hz DC
Rated operational voltage AC20 and DC20 (V)		AC 50/60 Hz
Rated operational current (A)	I_e	Electrical DC

125 V (2P in series)

250 V (4P in series)

Rated duties

Uninterrupted duty

Intermittent duty

Short-circuit making capacity (kA peak) **I_{cm}** Min. (switch-disconnector alone)Short-time withstand current (kA rms) **I_{cw}**

0.5 s

0.8 s

1 s

3 s

20 s

30 s

Suitability for isolation

Durability (O-C cycles)

Mechanical

Electrical DC

125 V (2P)

250 V (4P)

Positive contact indication

Visible break

Emergency-off switch disconnector

Degree of pollution

Upstream protection

See the "Complementary technical information" in catalogue Compact INS/INV "LVPED213024EN".

[1] Suitable for 480 V NEMA.

[2] For vertical connection busbars only. For horizontal connection busbars, see derating charts in "Installation recommendations" in catalogue Compact INS/INV "LVPED213024EN".

Switch-disconnector selection

Compact INV630b to 2500 DC

INV630b			INV800			INV1000			INV1250			INV1600			INV2000			INV2500		
3-4			3-4			3-4			3-4			3-4			3-4			3-4		
630			800			1000			1250			1600 ⁽²⁾			2000			2500		
630			800			1000			1250			1600 ⁽²⁾			2000			2500		
1000			1000			1000			1000			1000			1000			1000		
12			12			12			12			12			12			12		
690			690			690			690			690			690			690		
250			250			250			250			250			250			250		
800			800			800			800			800			800			800		
DC21A	DC22A	DC23A	DC21A	DC22A	DC23A	DC21A	DC22A	DC23A	DC21A	DC22A	DC23A	DC21A	DC22A	DC23A	DC21B	DC22B	DC23B	DC21B	DC22B	DC23B
630/2	630/2	630/2	800/2	800/2	800/2	1000/2	1000/2	1000/2	1250/2	1250/2	1250/2	1600/2	1600/2	1600/2	2000/2	2000/2	-	2500/2	2500/2	-
630/4	630/4	630/4	800/4	800/4	800/4	1000/4	1000/4	1000/4	1250/4	1250/4	1250/4	1600/4	1600/4	1600/4	2000/4	2000/4	-	2500/4	2500/4	-
⊙			⊙			⊙			⊙			⊙			⊙			⊙		
Class 120 - 60 %			Class 120 - 60 %			Class 120 - 60 %			Class 120 - 60 %			Class 120 - 60 %			Class 120 - 60 %			Class 120 - 60 %		
75			75			75			75			75			105			105		
50			50			50			50			50			50			50		
42			42			42			42			42			50			50		
35			35			35			35			35			50			50		
20			20			20			20			20			30			30		
10			10			10			10			10			13			13		
8			8			8			8			8			11			11		
⊙			⊙			⊙			⊙			⊙			⊙			⊙		
5000			3000			3000			3000			3000			3000			3000		
DC21A	DC22A	DC23A	DC21A	DC22A	DC23A	DC21A	DC22A	DC23A	DC21A	DC22A	DC23A	DC21A	DC22A	DC23B	DC21B	DC22B	DC23B	DC21B	DC22B	DC23B
1000	1000	1000	500	500	500	500	500	500	500	500	500	500	500	500	100	100	-	100	100	-
1000	1000	1000	500	500	500	500	500	500	500	500	500	500	500	500	100	100	-	100	100	-
⊙			⊙			⊙			⊙			⊙			⊙			⊙		
⊙			⊙			⊙			⊙			⊙			⊙			⊙		
⊙			⊙			⊙			⊙			⊙			-			-		
3			3			3			3			3			3			3		
-			-			-			-			-			-			-		



Switch-disconnector selection

Compact INV630b to 2500 DC

A

Compact INV switch-disconnectors

Installation

Fixed, front connection

Fixed, rear connection

On symmetrical rails

On a backplate

Connection

By cables

To bare cable connectors

By cables with lugs

Directly to terminals

To spreaders

To vertical-connection adapters via cable-lug adapters

Flat-facing bars

Directly to terminals

To spreaders

Edgewise bars

To vertical-connection adapters

Indication and measurement auxiliaries

Auxiliary contacts

Voltage-presence indicator

Current-transformer module

Ammeter module

Control, locking and interlocking

Control

Direct front rotary handle

Extended front rotary handle

Direct lateral rotary handle

Extended lateral rotary handle

Locking

By keylock

By padlocks

Interlocking

By keylock

Mechanical

Complete source-changeover assembly

Operating torque (Nm) (typical value for 3-4 poles with front handle)

Installation and connection accessories

Bare cable connectors

Rear connectors

Terminal extensions

Spreaders

One-piece spreader

Terminal shrouds

Terminal shields

Interphase-barrier

Front panel escutcheons

Coupling accessories

Tightening torque for electrical connections (Nm)

Dimensions and weights

Overall dimensions H x W x D (mm)

3 poles

4 poles

Approximate weight (kg)

3 poles

4 poles

Enclosure dimensions for lthe

H x W x D (mm)

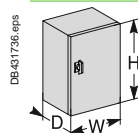

Switch-disconnector selection

Compact INV630b to 2500 DC

	INV630b	INV800	INV1000	INV1250	INV1600	INV2000	INV2500
	⊙	⊙	⊙	⊙	⊙	⊙	⊙
	⊙	⊙	⊙	⊙	⊙	⊙	⊙
	-	-	-	-	-	-	-
	⊙	⊙	⊙	⊙	⊙	⊙	⊙
	-	-	-	-	-	⊙	⊙
	-	-	-	-	-	-	-
	⊙	⊙	⊙	⊙	⊙	-	-
	⊙	⊙	⊙	⊙	⊙	⊙	⊙
	⊙	⊙	⊙	⊙	⊙	-	-
	⊙	⊙	⊙	⊙	⊙	-	-
	⊙	⊙	⊙	⊙	⊙	⊙	⊙
	-	-	-	-	-	-	-
	-	-	-	-	-	-	-
	-	-	-	-	-	-	-
	⊙	⊙	⊙	⊙	⊙	⊙	⊙
	⊙	⊙	⊙	⊙	⊙	⊙	⊙
	-	-	-	-	-	-	-
	⊙	⊙	⊙	⊙	⊙	⊙	⊙
	⊙	⊙	⊙	⊙	⊙	⊙	⊙
	⊙	⊙	⊙	⊙	⊙	⊙	⊙
	-	-	-	-	-	-	-
	30	30	30	30	30	60	60
	-	-	-	-	-	-	-
	-	-	-	-	-	-	-
	⊙	⊙	⊙	⊙	⊙	⊙	⊙
	⊙	⊙	⊙	⊙	⊙	⊙	⊙
	-	-	-	-	-	-	-
	-	-	-	-	-	-	-
	⊙	⊙	⊙	⊙	⊙	⊙	⊙
	⊙	⊙	⊙	⊙	⊙	⊙	⊙
	⊙	⊙	⊙	⊙	⊙	⊙	⊙
	-	-	-	-	-	-	-
	50	50	50	50	50	50	50
	300 x 340 x 146.5	300 x 340 x 146.5	300 x 340 x 146.5	300 x 340 x 146.5	300 x 340 x 146.5	440 x 347.5 x 227.5	440 x 347.5 x 227.5
	300 x 410 x 146.5	300 x 410 x 146.5	300 x 410 x 146.5	300 x 410 x 146.5	300 x 410 x 146.5	440 x 462.5 x 227.5	440 x 462.5 x 227.5
	14	14	14	14	14	35	35
	18	18	18	18	18	45	45
	-	-	-	-	-	-	-

A

Functions and characteristics

Communication

Enerlin'X communication system - Products overview

Enerlin[®] communication system provides access to status, electrical values and devices control using Ethernet and Modbus SL communication protocols.

Ethernet has become the universal link between switchboards, computers and communication devices inside the building. The large amount of information which can be transferred makes the connection of Enerlin'X digital system to hosted web services of Schneider Electric a reality. More advantages are offered to integrators thanks to configuration web pages available remotely or on the local Ethernet network.



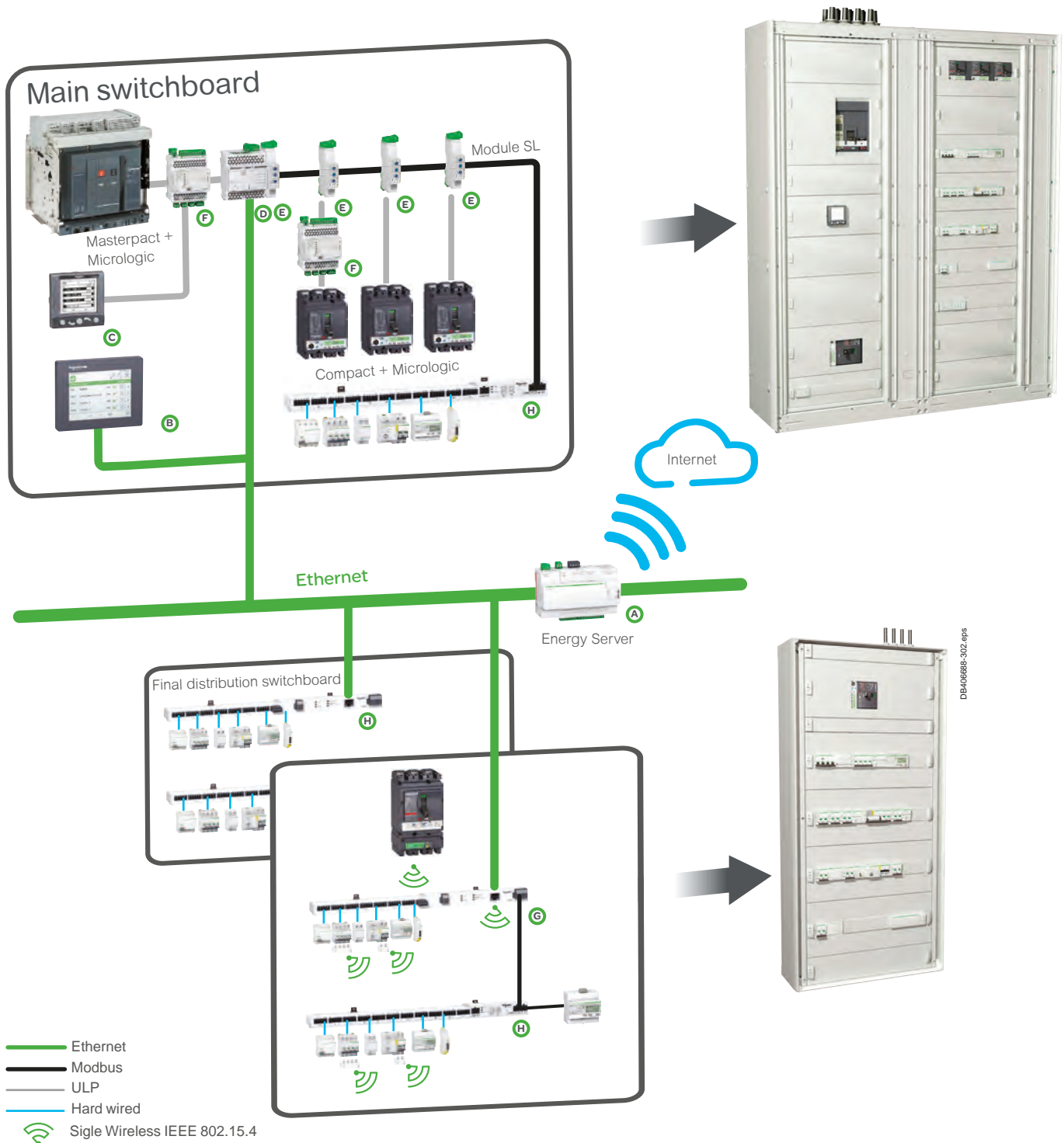





Modbus SL is the most widely used communication protocol in industrial networks. It operates in master-slave mode. The devices (slaves) communicate one after the other with a gateway (master).



- Ethernet
- Modbus
- ULP
- Hard wired
- Sigle Wireless IEEE 802.15.4

Communication

Enerlin'X communication system - Products overview

Enerlin'X digital devices and displays							
	Name	Function	Port (to device)	Port (to server)	Inputs	Outputs	Cial. Ref.
A	 Com'X 210	Energy data logger + Ethernet Gateway	Ethernet Modbus Master, Zigbee (to wireless meters)	Ethernet cable + WiFi	64 devices: 6 binary 2 analog 32 Modbus devices + other Ethernet devices (Modbus TCP)	-	EBX210
	Com'X 510 24 V DC + PoE	Energy server + Ethernet Gateway				-	EBX510
B	 FDM128	Ethernet LCD colour touch screen	-	Ethernet		-	LV434128
C	 FDM121	LCD display for circuit breaker	ULP	-	1 circuit breaker	-	TRV00121
D	 IFE Switchboard server	Switchboard server	Modbus Master & ULP	Ethernet	20 circuit breakers	-	LV434002
	IFE interface	Ethernet interface for circuit breakers	ULP	Ethernet	1 circuit breaker	-	LV434001
E	 IFM	Modbus interface for circuit breaker	ULP	Modbus Slave	1 circuit breaker	-	LV434000
F	 I/O	Input/Output application module for circuit breaker	ULP	ULP	6 binary 1 analog (PT100 sensor)	3	LV434063
G	 Acti 9 Smartlink SI B Ethernet wireless	Ethernet server for I/O and Modbus slave devices	Modbus Master & Wireless to PowerTag	Ethernet	14 binary 2 analog	7	A9XMZA08
H	 Acti 9 Smartlink Modbus slave	Modbus interface with Input/Output functions	-	Modbus Slave	22 binary	11	A9XMSB11

Ethernet Gateway or Interface: routes an internal traffic (ULP or other protocols) to the Internet, the outgoing messages are coded with Modbus TCP/IP protocol.

Server (Switchboard, Energy): routes the internal traffic to the Internet. Other complementary functions such as data logging and storage. Provides devices status and energy trends on internal web pages...

Communication

IFE Ethernet interface

PB115852.eps



IFE interface, ref.: LV434001

PB115824.eps



IFE interface + gateway, ref.: LV434002

DE406743.eps

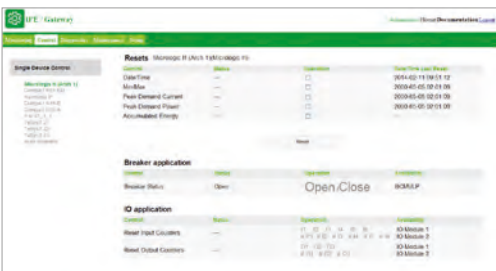

IFE interface, IFE interface + gateway description

Introduction

The IFE interface and IFE interface + gateway enable LV circuit breakers as Masterpact NT/NW, Compact NSX or Powerpact to be connected to an Ethernet network.

IFE interface: ref. LV434001

Provides an Ethernet access to a single LV circuit breaker.

Function

Interface - one circuit breaker is connected to the IFE interface via its ULP port.

IFE interface + gateway: ref. LV434002

Provides an Ethernet access to one or several LV circuit breakers.

Functions

- Interface - one circuit breaker is connected to the IFE interface via its ULP port.
- Gateway: several circuit breakers on a Modbus network are connected via the IFE interface + gateway master Modbus port.

IFE interface, IFE interface + gateway features

- Dual 10/100 Mbps Ethernet port for simple daisy chain connection.
- Device profile web service for discovery of the IFE interface, IFE interface + gateway on the LAN.
- ULP compliant for localization of the IFE interface in the switchboard.
- Ethernet interface for Compact, Masterpact and Powerpact circuit breakers.
- Gateway for Modbus-SL connected devices (IFE interface + gateway only).
- Embedded set-up web pages.
- Embedded monitoring web pages.
- Embedded control web pages.
- Built-in e-mail alarm notification.

Mounting

The IFE interface, IFE interface + gateway are DIN rail mounting devices. A stacking accessory enables the user to connect several IFMs (ULP to Modbus interfaces) to an IFE interface + gateway without additional wiring.

24 V DC power supply

The IFE interface, IFE interface + gateway must always be supplied with 24 V DC. The IFMs stacked to an IFE interface + gateway are supplied by the IFE interface + gateway, thus it is not necessary to supply them separately. It is recommended to use an UL listed and recognized limited voltage/limited current or a class 2 power supply with a 24 V DC, 3 A maximum.

IFE interface, IFE interface + gateway firmware update

The firmware can be updated using:

- FTP
- customer engineering tool.

Required circuit breaker communication modules

The connection to IFE interface or IFE interface + gateway requires a communication module embedded into the circuit breaker:

- Masterpact NT/NW (Fixed or drawout): BCM ULP communication module
- Drawout Masterpact NT/NW: BCM ULP and its respective I/O (Input/Output) application module.

All connection configurations for Masterpact NT/NW require the breaker ULP cord. The insulated NSX cord is mandatory for system voltages greater than 480 V AC. When the second ULP RJ45 connector is not used, it must be closed with an ULP terminator (TRV00880).

Network communication interface

Characteristic		Value
Type of interface module		Modbus RTU, RS485 serial connection Modbus TCP/IP Ethernet
Transmission	Modbus RS485	Transfer rate: 9,600...19,200 Baud Medium Double shielded twisted pair Impedance 120 Ω
	Ethernet	Transfer rate : 10/100 Mbps Medium STP, Cat5e, straight cable
Structure	Type	Modbus, Ethernet
	Method	Master/Slave
Device type	Modbus	Master
	Ethernet	Server
Turnaround time	Modbus	10 ms
	Ethernet	1 ms
Maximum length of cable	Modbus	1000 m
	Ethernet	100 m
Type of bus connector	Modbus	4-pin connector
	Ethernet	RJ45 (Shielded)

Communication IFE Ethernet interface

DB43737-005



General characteristics	
Environmental characteristics	
Conforming to standards	UL 508, UL 60950, IEC 60950, 60947-6-2
Certification	cULUs, GOST, FCC, CE
Ambient temperature	-20 to +70 °C (-4 to +158 °F)
Relative humidity	5–85 %
Level of pollution	Level 3
Flame resistance	ULV0
Mechanical characteristics	
Shock resistance	1000 m/s ²
Resistance to sinusoidal vibrations	-5 Hz < f < 8.4 Hz
Electrical characteristics	
Resistance to electromagnetic discharge	Conforming to IEC/EN 61000-4-3
Immunity to radiated fields	10 V/m
Immunity to surges	Conforming to IEC/EN 61000-4-5
Consumption	120 mA at 24 V input
Physical characteristics	
Dimensions	72 x 105 x 71 mm (2.83 x 4.13 x 2.79 in.)
Mounting	DIN rail
Weight	182.5 g (0.41 lb)
Degree of protection of the installed IO	<ul style="list-style-type: none"> ■ On the front panel (wall mounted enclosure): IP4x ■ Connectors: IP2x ■ Other parts: IP3x
Connections	Screw type terminal blocks
Technical characteristics - 24 V DC power supply	
Power supply type	Regulated switch type
Rated power	72 W
Input voltage	100–120 V AC for single phase 200–500 V AC phase-to-phase
PFC filter	With IEC 61000-3-2
Output voltage	24 V DC
Power supply out current	3 A
Note: it is recommended to use an UL listed/UL listed recognized limited voltage/Limited current or a class 2 power supply with a 24 V DC, 3 A maximum.	
IFE web page description	
Monitoring web page	
Real time data 67	<input type="radio"/>
Device logging	<input type="radio"/>
Control web page	
Single device control	<input type="radio"/>
Diagnostics web page	
Statistics	<input type="radio"/>
Device information	<input type="radio"/>
IMU information	<input type="radio"/>
Read device registers	<input type="radio"/>
Communication check	<input type="radio"/>
Maintenance web page	
Maintenance log	<input type="radio"/>
Maintenance counters	<input type="radio"/>
Setup web page	
Device localization/name	<input type="radio"/>
Ethernet configuration (dual port)	<input type="radio"/>
IP configuration	<input type="radio"/>
Modbus TCP/IP filtering	<input type="radio"/>
Serial port	<input type="radio"/>
Date and time	<input type="radio"/>
E-mail server configuration	<input type="radio"/>
Alarms to be e-mailed	<input type="radio"/>
Device list	<input type="radio"/>
Device logging	<input type="radio"/>
Device log export	<input type="radio"/>
SNMP parameters	<input type="radio"/>
Documentation links	<input type="radio"/>
Preferences	<input type="radio"/>
Advanced services control	<input type="radio"/>
User accounts	<input type="radio"/>
Web page access	<input type="radio"/>

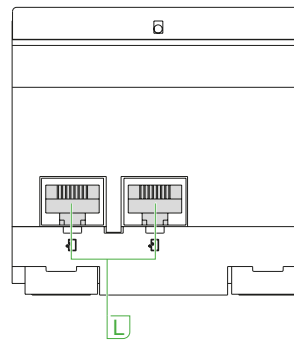
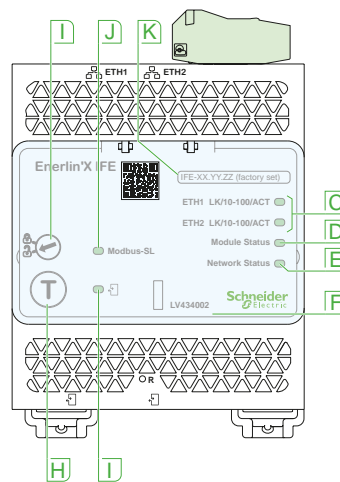
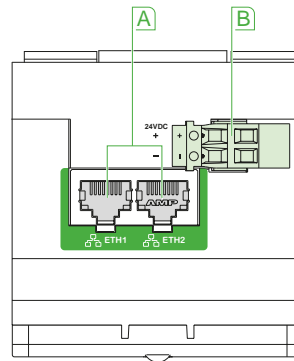

- A** Ethernet 1 and Ethernet 2 communication port.
- B** 24 V DC power supply terminal block.
- C** Ethernet communication LEDs:
 - yellow: 10 Mb
 - green: 100 Mb.
- D** Module status LED:
 - steady off: no power
 - steady green: device operational
 - steady red: major fault
 - flashing green: standby
 - flashing red: minor fault
 - flashing green/red: self-test.
- E** Network status LED:
 - steady off: not power/no valid IP address
 - steady green: connected, valid IP address
 - steady orange: default IP address
 - steady red: duplicated IP address
 - flashing green/red: Self-test.
- F** Sealable transparent cover.
- G** ULP status LED.
- H** Test button (accessible closed cover).
- I** Locking pad.
- J** Modbus traffic status LED (LV434002 only).
- K** Device name label.
- L** ULP ports.

Communication

IFM Modbus communication interface



IFM Modbus communication interface.
Ref.: LV434000.

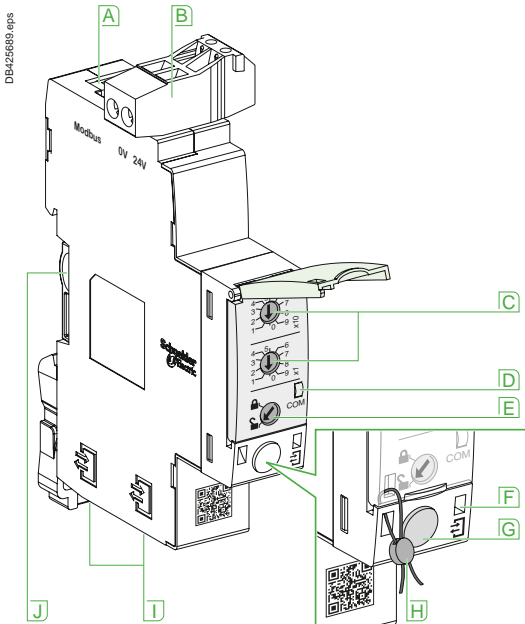

- A** Modbus screw clamp connector.
- B** Modbus address switches.
- C** Modbus traffic LED.
- D** Modbus locking pad.
- E** ULP activity LED.
- F** Test button.
- G** Mechanical lock.
- H** ULP RJ45 connectors.
- I** Stacking accessory connection.

Simplified IFM installation

Stacking IFM

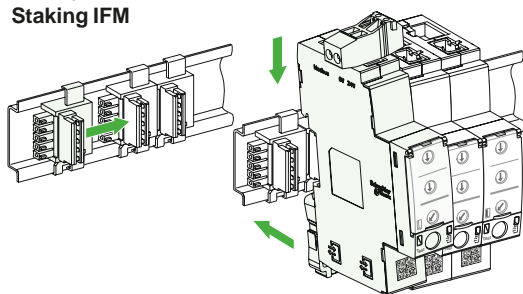

Stacking accessories

Up to 12 stacked IFM

Function

A IFM - Modbus communication interface - is required for connection of a Masterpact or Compact to a Modbus network as long as this circuit breaker is provided with a ULP (Universal Logic Plug) port. The port is available on respectively a BCM ULP or BSCM embedded module.

The IFM is defined as an IMU (Intelligent Modular Unit) in the ULP connection System documentation.

Once connected, the circuit breaker is considered as a slave by the Modbus master. Its electrical values, alarm status, open/close signals can be monitored or controlled by a Programmable Logic Controller or any other system.

Characteristics

ULP port

2 RJ45 sockets, internal parallel wiring.

- Connection of a single circuit breaker (eventually via its I/O application module).
- A ULP line terminator or an FDM121 display unit must be connected to the second RJ45 ULP socket.

The RJ45 sockets deliver a 24 VDC supply fed from the Modbus socket.

Built-in test function, for checking the correct connection to the circuit breaker and FDM121 display unit.

Modbus slave port

- Top socket for screw-clamp connector, providing terminals for:

- 24 VDC input supply (0V, +24V)
- Modbus line (D1, D2, Gnd).

- Lateral socket, for Din-rail stackable connector.

Both top and lateral sockets are internally parallel wired.

- Multiple IFM can be stacked, thus sharing a common power supply and Modbus line without individual wiring.

- On the front face:

- Modbus address setting (1 to 99): 2 coded rotary switches

- Modbus locking pad: enables or disables the circuit breaker remote control and modification of IFM parameters.

- Self adjusting communication format (Baud rate, parity).

Technical characteristics

IFM Modbus communication interface		
Dimensions		18 x 72 x 96 mm
Maximum number of stacked IFM		12
Degree of protection of the installed module	Part projecting beyond the escutcheon	IP4x
	Other module parts	IP3x
	Connectors	IP2x
Operating temperature		-25...+70 °C
Power supply voltage		24 V DC -20 %/+10 % (19.2...26.4 V DC)
Consumption	Typical	21 mA/24 V DC at 20 °C
	Maximum	30 mA/19.2 V DC at 60 °C
Certification		
CE		IEC/EN 60947-1
UL		UL 508 - Industrial Control Equipment
CSA		No. 142-M1987 - Process Control Equipment
		■ CAN/CSA C22.2 No. 0-M91 - General requirements - Canadian Electrical Code Part
		■ CAN/CSA C22.2 No. 14-05 - Industrial Control Equipment

Stacking an IFE interface + gateway with IFM

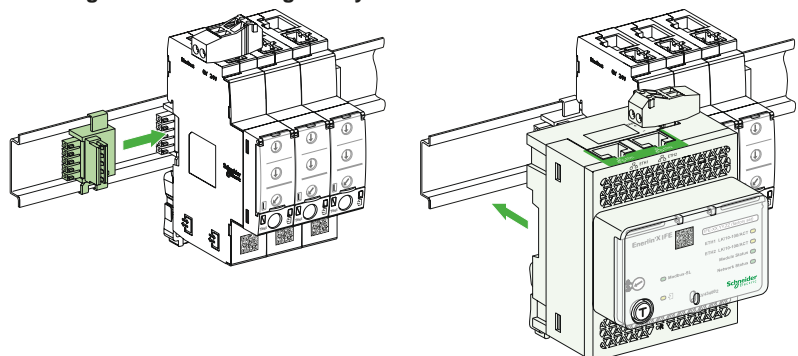

Communication

COM option in Compact and Masterpact

All the Masterpact devices can be fitted with the communication function thanks to the COM option. Masterpact uses the Ethernet or Modbus communications protocol for full compatibility with the supervision management systems. Eco COM is limited to the transmission of metering data. It is not used to communicate status and controls.

For fixed and Drawout devices, the common communication option is made up of:

- a BCM ULP module, installed behind the Micrologic control unit and supplied with its set of sensors (OF, SDE, PF and CH micro switches) its kit for connection to XF and MX1 communicating voltage releases and its COM terminal block (inputs E1 to E6). This module is independent of the control unit. It receives and transmits information on the communication network. An infra-red link transmits data between the control unit and the communication module.

Consumption: 30 mA, 24 V.

- IFM, this module required for connection to the network, contains the Modbus address (1 to 99) declared by the user via the two dials in front. It automatically adapts (baud rate, parity) to the Modbus network in which it is installed.

Or

- IFE, the Ethernet interface for LV circuit breaker enables an intelligent modular unit (IMU), for example a Masterpact NT/NW or Compact NSX circuit breaker to be connected to an Ethernet network. Each circuit breaker has its own IFE and a corresponding IP address.

For drawout device the Cradle Management option must be added:

I/O (Input/Output) application module for LV breaker, the I/O application module is delivered with withdrawable devices ordered with the COM option, for cradle management. It must be installed on a DIN rail near the device. It must be connected to the ULP system and to the position contacts (CD, CT, CE) that transmit the position of the device in the cradle.

For communicating remote control, option with XF and MX1 communicating voltage releases must be added:

The XF and MX1 communicating voltage releases are equipped for connection to the "device" communication module.

The remote-tripping function (MX2 or MN) are independent of the communication option. They are not equipped for connection to the "device" communication module.

BSCM module

Functions

The optional BSCM Breaker Status & Control Module is used to acquire device status indications and control the communicating remote-control function. It includes a memory used to manage the maintenance indicators.

Status indications

Indication of device status:
O/F, SD and SDE.

Maintenance indicators

The BSCM module manages the following indicators:

- mechanical operation counter
- electrical operation counter
- history of status indications.

It is possible to assign an alarm to the operation counters.

Controls

The module can be used to carry out communicating remote control operations: (open, close and reset) in different modes (manual, auto).

Mounting

The BSCM module can be installed on all Compact NSX circuit breakers and switch-disconnectors. It simply clips into the auxiliary contact slots. It occupies the slots of one O/F contact and one SDE contact. The BSCM is supplied with 24 V DC power automatically via the NSX cord when the communication system is installed.



BCM ULP.

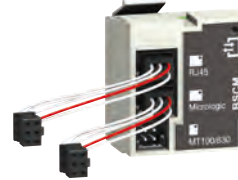

BSCM module.



PB106674-20.eps

PB103786.eps

Communication

I/O application module



I/O application module

A

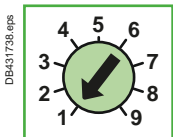

Description

The I/O input/output application module for LV breaker is part of an ULP system with built-in functionalities and applications to enhance the application needs. The ULP system architecture can be built without any restrictions using the wide range of circuit breakers.

The I/O application is compliant with the ULP system specifications. Two I/O application module can be connected in the same ULP network.

The ranges of LV circuit breakers enhanced by the I/O are:

- Masterpact NW
- Masterpact NT
- Compact NS1600b-3200
- Compact NS630b-1600
- Compact NSX100-630 A.

I/O input/output interface for LV breaker resources

The I/O application module resources are:

- 6 digital inputs that are self powered for either NO and NC dry contact or pulse counter
- 3 digital outputs that are bistable relay (5 A maximum)
- 1 analog input for Pt100 temperature sensor.

Pre-defined applications

Pre-defined application adds new functions to the IMU in a simple way:

- selection by the application rotary switch on the I/O, defining the application with pre-defined input/output assignment and wiring diagram.
- no additional setting with the customer engineering tool required.

The resources not assigned to the pre-defined application are free for additional user-defined applications:

- cradle management
- breaker operation
- light and load control
- custom.

User-defined applications

User-defined applications are processed by the I/O in addition to the pre-defined application selected.

The user-defined applications are available depending on:

- the pre-defined application selected
- the I/O resources (inputs and outputs) not used by the application.

The resources required by user-defined applications are assigned using the customer engineering tool:

- protection
- control
- energy management
- monitoring.

Mounting

The I/O is a DIN rail mounting device.

Application rotary switch

The application rotary switch enables the selection of the pre-defined application.

It has 9 positions and each position is assigned to a pre-defined application.

The factory set position of the switch is pre-defined application 1.

Setting locking pad

The setting locking pad on the front panel of the I/O enables the setting of the I/O by the customer engineering tool.

Functions and characteristics

Communication

I/O application module



General characteristics	
Environmental characteristics	
Conforming to standards	UL 508, UL 60950, IED 60950, 60947-6-2
Certification	cUIUs, GOST, FCC, CE
Ambient temperature	-20 to +70 °C (-4 to +158 °F)
Relative humidity	5–85 %
Level of pollution	Level 3
Flame resistance	ULV0
Mechanical characteristics	
Shock resistance	1000 m/s ²
Resistance to sinusoidal vibrations	-5 Hz < f < 8.4 Hz
Electrical characteristics	
Resistance to electromagnetic discharge	Conforming to IEC/EN 61000-4-3
Immunity to radiated fields	10 V/m
Immunity to surges	Conforming to IEC/EN 61000-4-5
Consumption	165 mA
Physical characteristics	
Dimensions	71.7 x 116 x 70.6 mm (2.83 x 4.56 x 2.78 in.)
Mounting	DIN rail
Weight	229.5 g (0.51 lb)
Degree of protection of the installed IO	<ul style="list-style-type: none"> ■ On the front panel (wall mounted enclosure): IP4x ■ IO parts: IP3x ■ Connectors: IP2x
Connections	Screw type terminal blocks
Technical characteristics - 24 V DC power supply	
Power supply type	Regulated switch type
Rated power	72 W
Input voltage	100–120 V AC for single phase 200–500 V AC phase-to-phase
PFC filter	With IEC 61000-3-2
Output voltage	24 V DC
Power supply out current	3 A
Note: it is recommended to use an UL listed/UL listed recognized limited voltage/Limited current or a class 2 power supply with a 24 V DC, 3 A maximum.	
Digital inputs	
Digital input type	Self powered digital input with current limitations as per IEC 61131-2 type 2 standards (7 mA)
Input limit values at state 1 (close)	19.8–25.2 V DC, 6.1–8.8 mA
Input limit values at state 0 (open)	0–19.8 V DC, 0 mA
Maximum cable length	10 m (33 ft)
Note: for a length greater than 10 m (33 ft) and up to 300 m (1,000 ft), it is mandatory to use a shielded twisted cable. The shield cable is connected to the IO functional ground of the IO.	
Digital outputs	
Digital output type	Bistable relay
Rated load	5 A at 250 V AC
Rated carry current	5 A
Maximum switching voltage	380 V AC, 125 V DC
Maximum switch current	5 A
Maximum switching power	1250 VA, 150 W
Minimum permissible load	10 mA at 5 V DC
Contact resistance	30 mΩ
Maximum operating frequency	<ul style="list-style-type: none"> ■ 18000 operations/hr (Mechanical) ■ 1800 operations/hr (Electrical)
Digital output relay protection by an external fuse	External fuse of 5 A or less
Maximum cable length	10 m (33 ft)
Analog inputs	
The IO analog input can be connected to a Pt100 temperature sensor	
Range	-30 to 200 °C -22 to 392 °F
Accuracy	<ul style="list-style-type: none"> ±2 °C from -30 to 20 °C ±3.6 °F from -22 to 68 °F ±1 °C from 20 to 140 °C ±1.8 °F from 68 to 284 °F ±2 °C from 140 to 200 °C ±3.6 °F from 284 to 392 °F
Refresh interval	5 s 5 s

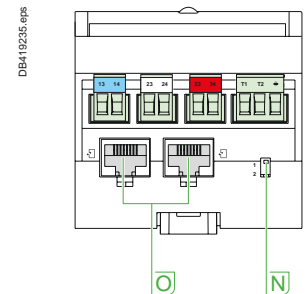
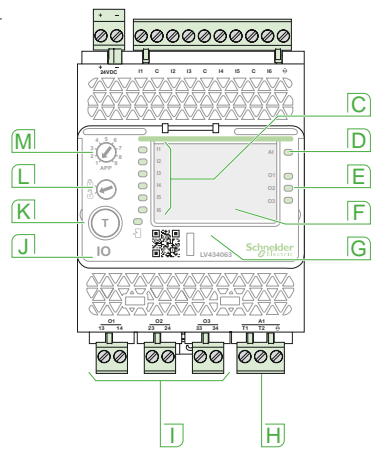
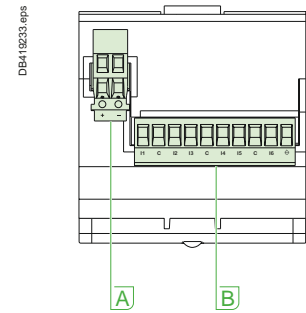

- A** 24 V DC power supply terminal block.
- B** Digital input terminal block: 6 inputs, 3 commons and 1 shield.
- C** 6 input status LEDs.
- D** Analog input status LED.
- E** 3 output status LEDs.
- F** I/O identification labels.
- G** Sealable transparent cover.
- H** Analog input terminal block.
- I** Digital output terminal blocks.
- J** ULP status LED.
- K** Test/reset button (accessible with cover closed).
- L** Setting locking pad.
- M** Application rotary switch: 1 to 9.
- N** Switch for IO addressing (IO 1 or IO 2).
- O** ULP connectors.

Communication

Communications modules, IFM and IFE for Compact NSX

All Compact NSX devices can be equipped with the communication function via a prewired connection system and a Modbus or Ethernet network interface.

The interface can be connected directly or via the FDM121 switchboard display unit. Four functional levels can be combined to adapt to all supervision requirements.

A

Four functional levels

The Compact NSX can be integrated in a Modbus or Ethernet communication environment. Four functional levels can be used separately or combined.

Communication of status indications

This level is compatible with all Compact NSX circuit breakers, whatever the trip unit, and with all switch-disconnectors. Using the BSCM module, the following information is accessible:

- ON/OFF position (O/F)
- trip indication (SD)
- fault-trip indication (SDE).

Communication of commands

Also available on all circuit breakers and switch-disconnectors, this level (communicating remote control) can be used to:

- open
- close
- reset.

Modbus principle

The Modbus RS 485 (RTU protocol) system is an open bus on which communicating Modbus devices (Compact NS with Modbus COM, Power Meter PM700, PM800, Sepam, Vigilohm, Compact NSX, etc.) are installed. All types of PLCs and microcomputers may be connected to the bus.

Addresses

The Modbus communication parameters (address, baud rate, parity) are entered using the Electrical Asset Manager or RSU (Remote Setting Utility).

Number of devices

The maximum number of devices that may be connected to the Modbus bus depends on the type of device (Compact with Modbus COM, PM700, PM800, Sepam, Vigilohm, Compact NSX, etc.), the baud rate (19200 is recommended), the volume of data exchanged and the desired response time. The RS 485 physical layer offers up to 32 connection points on the bus (1 master, 31 slaves).

A fixed device requires only one connection point (communication module on the device). A drawout device uses two connection points (communication modules on the device and on the chassis).

The number must never exceed 31 fixed devices or 15 drawout devices.

Length of bus

The maximum recommended length for the Modbus bus is 1200 meters.

Bus power source

A 24 V DC power supply is required (less than 20 % ripple, insulation class II).

Ethernet principle

Ethernet is a data link and physical layer protocol defined by IEEE 802.10 and 100 Mbps specifications that connects computer or other Ethernet devices. Ethernet is an asynchronous Carrier Sense Multiple Access with Collision detection (referred as CSMA/CD) protocol. Carrier Sense means that the hosts can detect whether the medium (coaxial cable) is idle or busy. Multiple Access means that multiple hosts can be connected to the common medium. Collision Detection means a host detects whether its transmission has collided with the transmission of another host (or hosts). IFE Ethernet interface can be connected to a PC or a laptop over Ethernet.

The maximum length of Ethernet cable is 100 meters. IFE Ethernet interface + gateway provides a Modbus TCP/IP gateway over Ethernet to enable Modbus TCP communication from a Modbus TCP master to any Modbus slave devices connected to it. The maximum active Modbus TCP client connection is twelve.

IFE Ethernet interface has an embedded web server (web page).

The Modbus RS 485 (RTU protocol) system is an open bus on which communicating Modbus devices (Compact NS with Modbus COM, Power Meter PM700, PM800, Sepam, Vigilohm, Compact NSX, etc.) are installed. All types of PLCs and microcomputers may be connected to the bus.

Communication components and connections

Connections

- Compact NSX is connected to the I/O application module or FDM121 display unit via the internal terminal block for the NSX cord equipped with an RJ45 connector:
 - cord available in three lengths: 0.35 m, 1.3 m and 3 m.
 - insulated 1.3 m version for installations > 480 V AC
 - lengths up to 10 m possible using extensions.
- The FDM121 display unit and the I/O application module are connected to:
 - the IFM Modbus interface by a communication cable with RJ45 connectors on both ends
 - or
 - the IFE Ethernet interface module by a communication cable with RJ45 connectors on both ends.

DB431742.eps

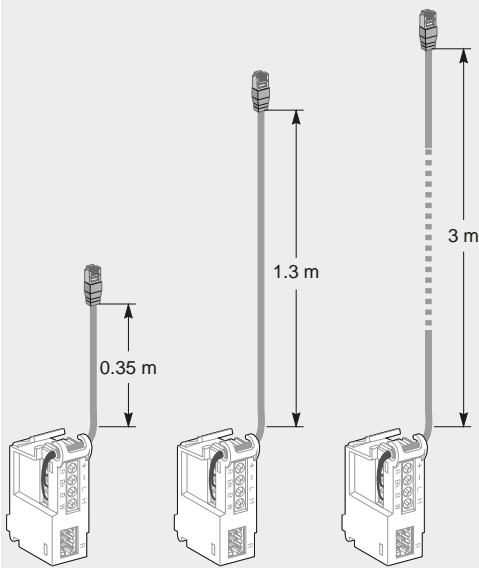

Communication components and connections, IFM

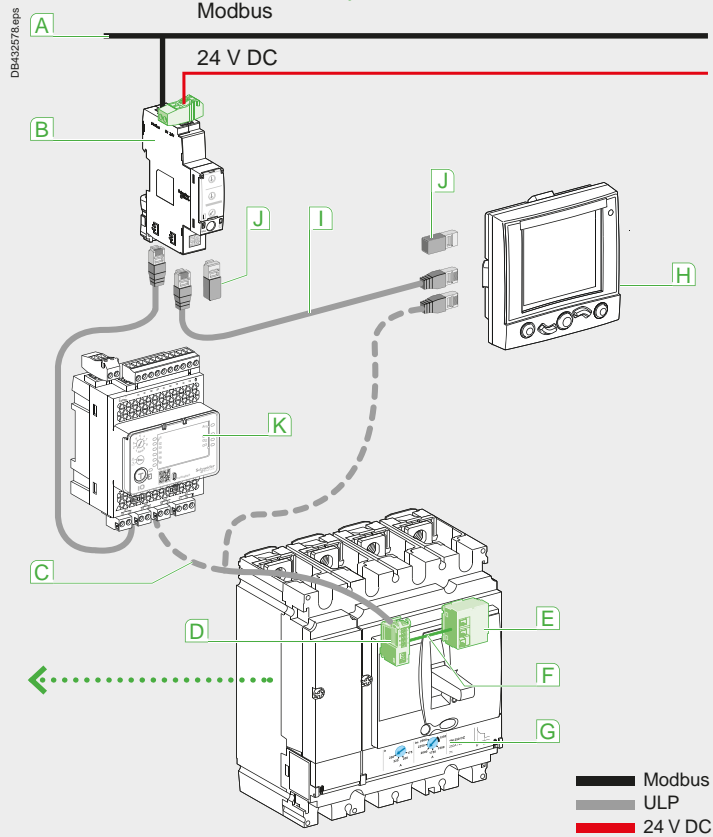

— Modbus
— ULP
— 24 V DC

Communication components and connections, IFE

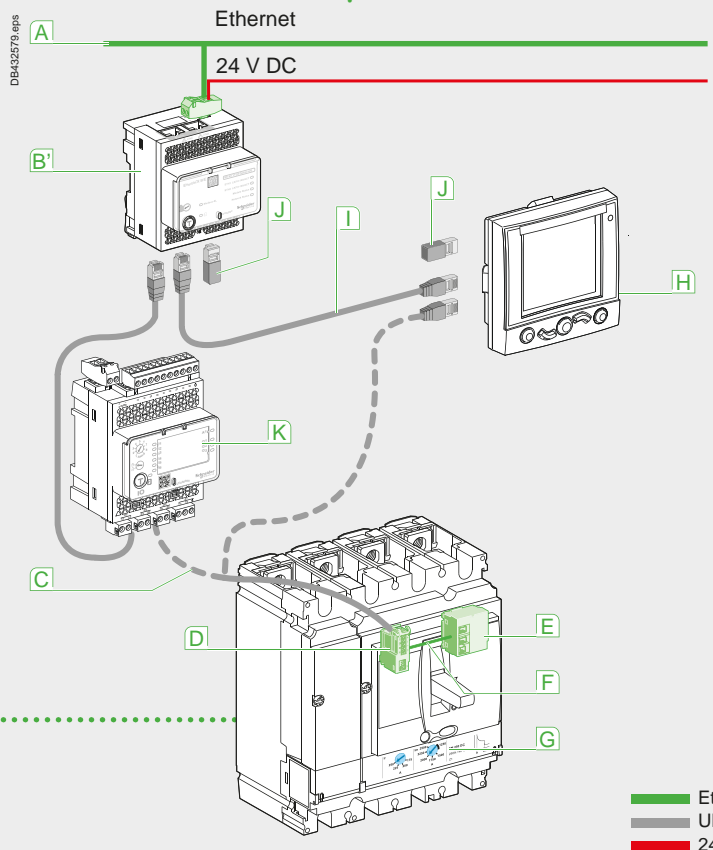

— Ethernet
— ULP
— 24 V DC

- A Modbus network
- B IFM Modbus interface
- B' IFE Ethernet interface module
- C NSX cord
- D Internal terminal block for communication via NSX cord
- E BSCM module
- F Prefabricated wiring
- G TMD trip unit
- H FDM121 display
- I RJ45 cable
- J Line terminator (on unused connector if applicable)
- K I/O application module



Communication

Connection of the IFE to a fixed or drawout Masterpact NW

Connect the IFE to a fixed electrically operated Masterpact NW or circuit breaker using the breaker ULP cord

Connect the IFE to a drawout Masterpact NW or circuit breaker using the breaker ULP cord

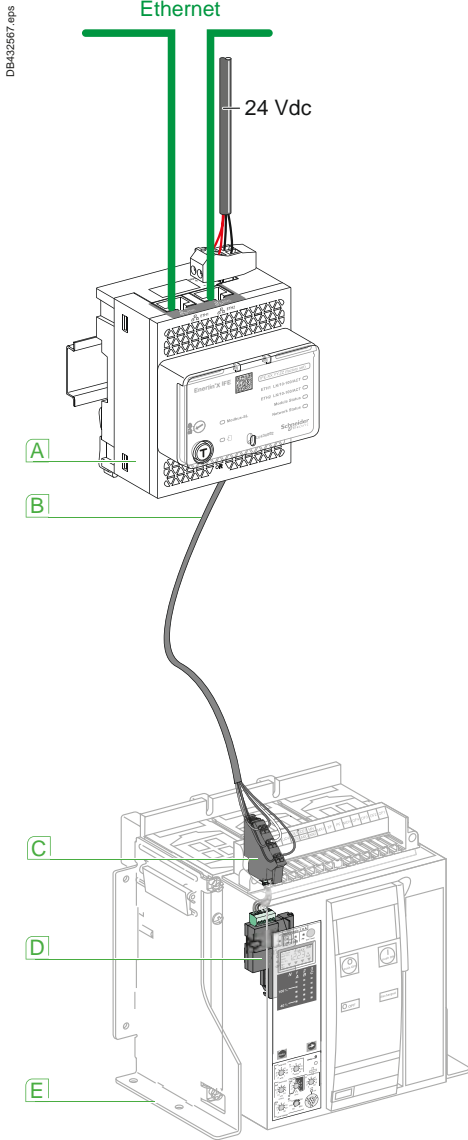

- A** IFE Ethernet interface for LV circuit breaker
- B** Breaker ULP cord
- C** Fixed COM terminal block
- D** BCM ULP communication module
- E** Fixed electrically operated circuit breaker

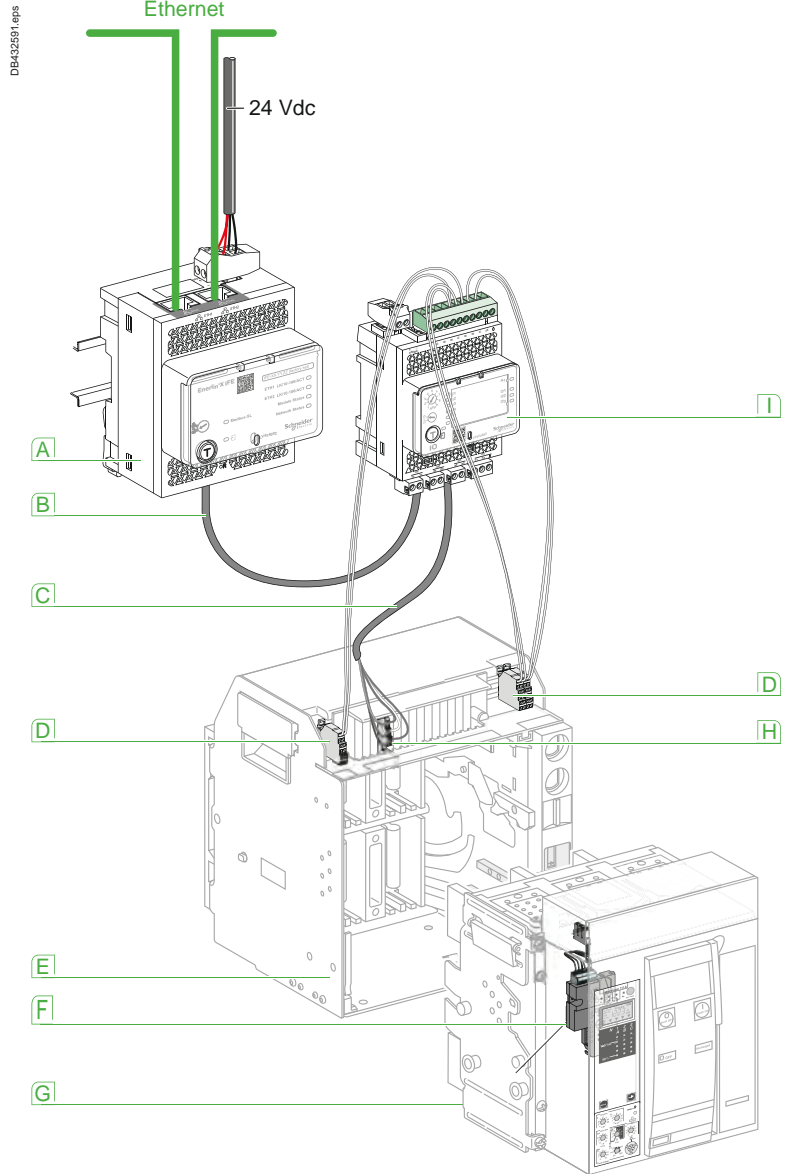

- A** IFE Ethernet interface for LV circuit breaker
- B** ULP cable
- C** Breaker ULP cord
- D** Drawout device position contacts
- E** Circuit breaker cradle
- F** BCM ULP communication module
- G** Drawout circuit breaker
- H** Drawout COM terminal block
- I** I/O (Input/Output) application module for LV circuit breaker

A

Communication

Connection of the IFM to a fixed or drawout Masterpact NW

Connect the IFM to a fixed electrically operated Masterpact NW or circuit breaker using the breaker ULP cord

Connect the IFM to a drawout Masterpact NW or circuit breaker using the breaker ULP cord

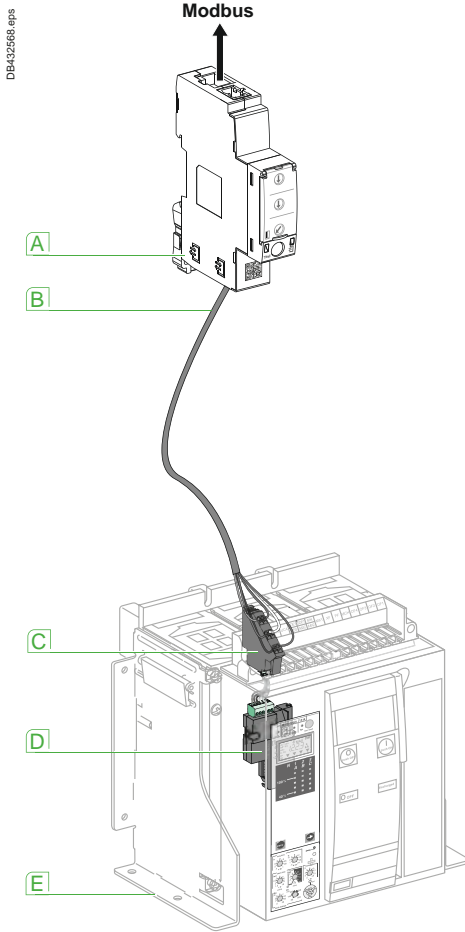

- A** IFM Ethernet interface for LV circuit breaker
- B** Breaker ULP cord
- C** Fixed COM terminal block
- D** BCM ULP communication module
- E** Fixed electrically operated circuit breaker

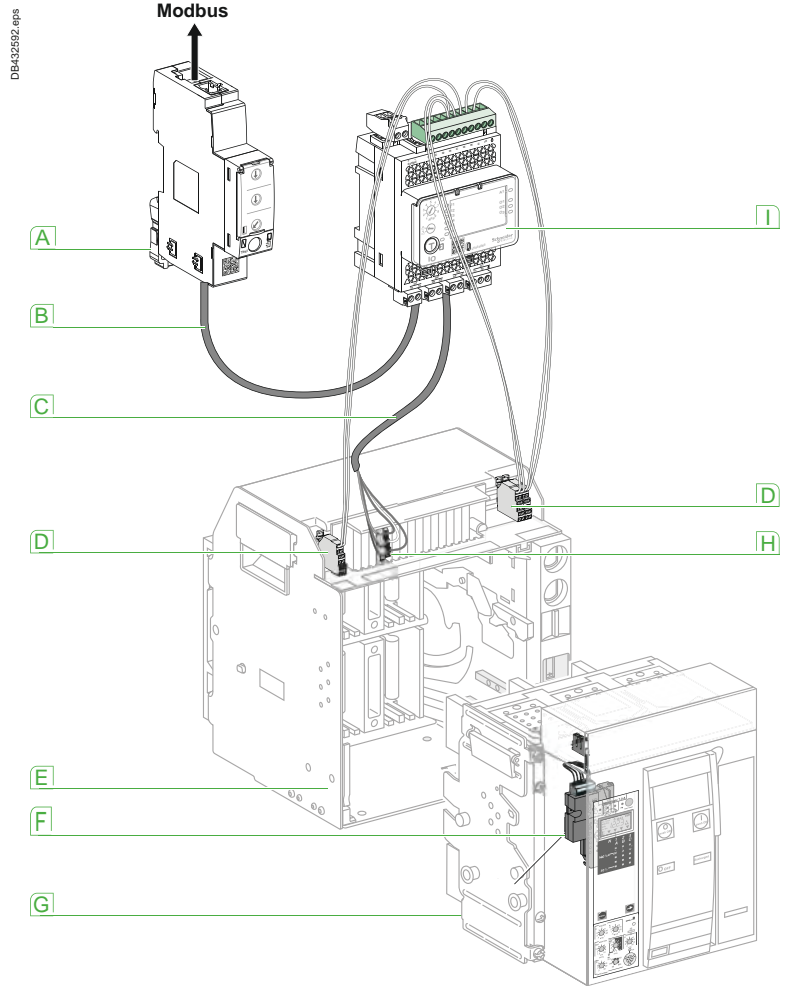

- A** IFM Ethernet interface for LV circuit breaker
- B** ULP cable
- C** Breaker ULP cord
- D** Drawout device position contacts
- E** Circuit breaker cradle
- F** BCM ULP communication module
- G** Drawout circuit breaker
- H** Drawout COM terminal block
- I** I/O (Input/Output) application module for LV circuit breaker



Communication

Electrical Asset Manager Configuration Engineering tool

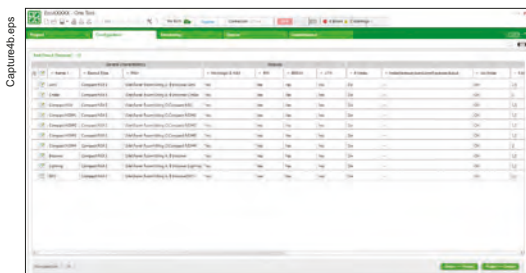
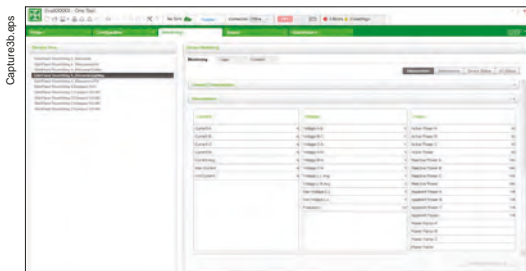
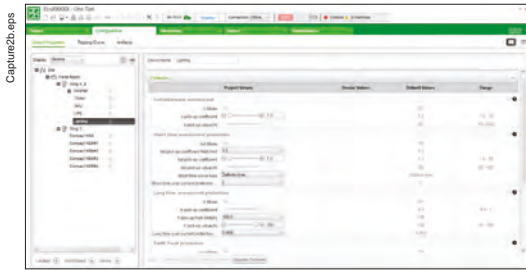
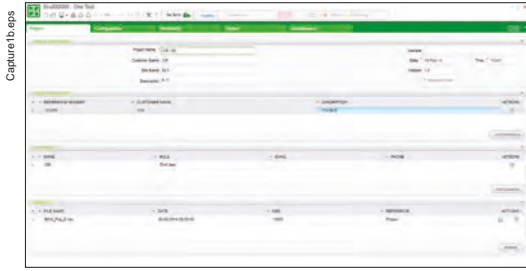

Introduction

Electrical Asset Manager is a software application that helps the user to manage a project as part of designing, testing, site commissioning, and maintenance of the project life cycle.

It enables the user to prepare the settings of the devices offline (without connecting to the device) and configure them when connected with the devices.

Also it provides lot of other value added features for the user to manage the project such as, safe repository in cloud, attach artifacts to each device or at the project level, organize devices in switchboard wise, manage a hierarchical structure of the installation etc.

Compatible devices (configuration and device management)

Electrical Asset Manager is compatible with the following devices:

- Compact NSX100-630 (IEC)
- PowerPact™ (UL) circuit breaker
- Compact NS630b-3200 (IEC)
- Masterpact NT/NW (IEC and UL) circuit breaker
- Acti9 Smartlink.
- Compatible devices (Device Management in the project)
- Switch disconnectors (Compact NSX, Masterpact & PowerPact Family)
- Third party devices.

References:

Electrical Asset Manager software package can be downloaded from our website www.schneider-electric.com.

Features

Electrical Asset Manager supersedes the Schneider Electric customer engineering tools such as Remote setting Utility (RSU) and Remote Control Utility (RCU) with additional features.

Electrical Asset Manager supports the connection of Schneider Electric communicable devices to:

- create projects by device discovery, selection of devices, and import Bill of Material (BOM)
- monitor the status of protection and IO status
- read information (alarms, measurements, parameters)
- check protection selectivity between two devices
- upload and download of configuration or settings in batch mode to multiple devices.
- carry out commands and tests
- generate and print device settings report and communication test report
- manage multiple devices with electrical and communication hierarchy model
- manage artifacts (project documents)
- check consistency in settings between devices on a communication network
- compare configuration settings between PC and device (online)
- download latest firmware.

Electrical Asset Manager enables the user to avail the advanced features of the software once the project is saved in Schneider Electric cloud.

Communication

Electrical Asset Manager Configuration Engineering tool

Functions

Offline Mode

A project can be built in offline mode through 2 different ways:

- through BOM file import
- through Device Selection.

Additionally, the user can open an existing project and modify the settings offline. The user can do the selectivity curve check and firmware compatibility check for devices in the project.

Online Mode

A project can be built in online mode through device discovery also other than the methods possible through offline method.

Once the project is built, the following functions can be performed in addition to the functions available in offline mode:

- compare the device parameters with project parameters
- load parameters from project to the device and vice versa
- firmware downloads to the device
- monitor the measurement, maintenance, device status and I/O status
- control functions.

User Interface

Electrical Asset Manager software provides fast direct access to the project and the devices in the project through different tabs.

- Project: to provide the project information including customer details, project references and to add project artifacts (documents related to the project).
- Configuration: to build up the tree structure of the project architecture ; to have a table view of the devices added in the project ; to set the parameters of the devices ; to transfer the device settings ; to view the tripping curves; to attach device artifacts and to download the latest firmware, to do the communication test for all the devices and generate the test report.
- Monitoring: this allows the user to monitor the real time values of different devices through different sub tabs namely Monitoring, Logs and Control.
- Reports: report tab allows you to generate and print a report of the project settings from the report tab. The user details and project characteristics are automatically filled with the details entered in the Project page.

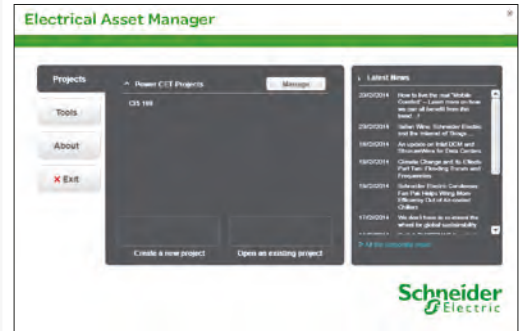

Capture8Steps

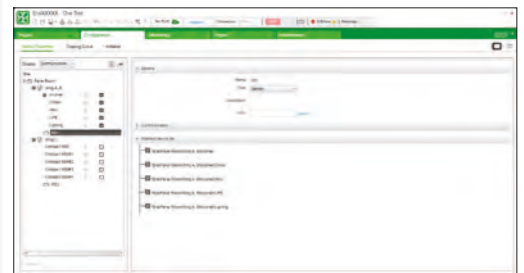

Capture8Steps

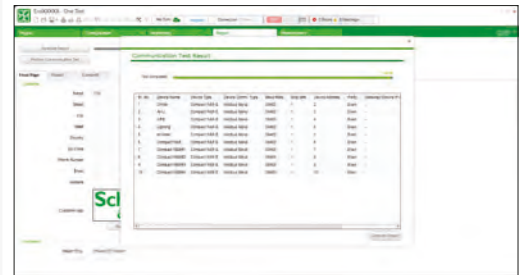

Capture7Steps

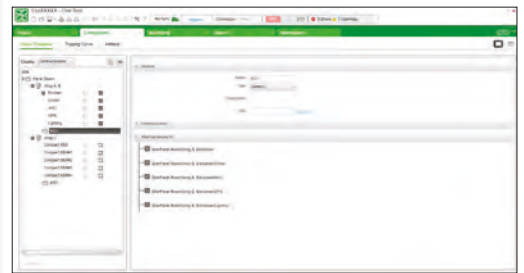

Capture8Steps

General characteristics of Masterpact NW DC - DC PV

Operating conditions

Masterpact circuit breakers have been tested for operation in industrial atmospheres. It is recommended that the equipment be cooled or heated to the proper operating temperature and kept free of excessive vibration and dust.

A

DE43749.eps

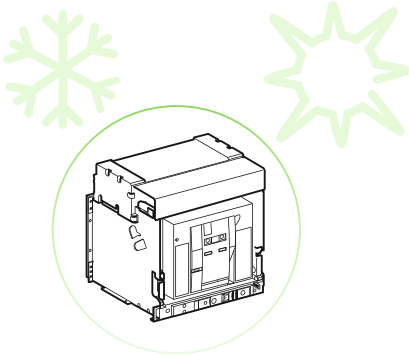

DE43750.eps

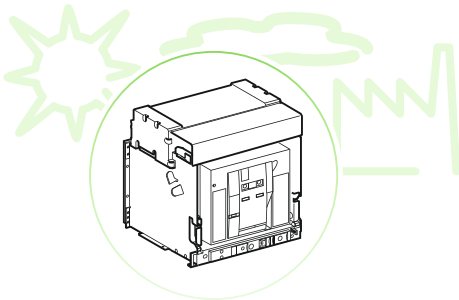

DE43751.eps

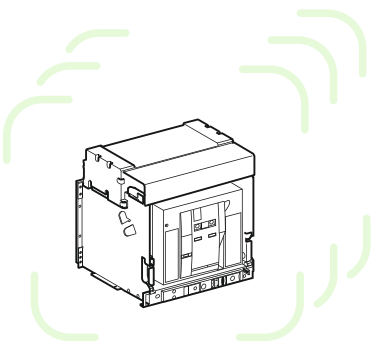

Ambient temperature

Masterpact devices can operate under the following temperature conditions:

- the electrical and mechanical characteristics are stipulated for an ambient temperature of -25 °C to +70 °C

- Circuit breaker closing is guaranteed down to -35 °C by manual operation (push button).

Storage conditions are as follows:

- -40 to +85 °C for a Masterpact device without its control unit
- -25 °C to +85 °C for the control unit.

Extreme atmospheric conditions

Masterpact devices have successfully passed the tests defined by the following standards for extreme atmospheric conditions:

- IEC 60068-2-1: dry cold at -40 °C
- IEC 60068-2-2: dry heat at +85 °C
- IEC 60068-2-30: damp heat (temperature +55 °C, relative humidity 95 %)
- IEC 60068-2-52 level 2: salt mist.

Masterpact devices can operate in the industrial environments defined by standard IEC 60947 (pollution degree up to 4).

It is nonetheless advised to check that the devices are installed in suitably cooled switchboards without excessive dust.

Vibrations

Masterpact devices have successfully passed testing in compliance with IEC 60068-2-6 for the following vibration levels:

- 2 to 13.2 Hz: amplitude ± 1 mm
- 13.2 to 100 Hz: constant acceleration 0.7 g.

Vibration testing to these levels is required by merchant marine inspection organisations (Veritas, Lloyd's, etc). Some applications have vibration profiles outside of this standard and require special attention during application design, installation, and use. Excessive vibration may cause unexpected tripping, damage to connections or to other mechanical parts. Please refer to the Masterpact maintenance guide (causes of accelerated ageing / operating conditions / vibrations) for additional information.

Examples of applications with high vibration profiles could include:

- wind turbines
- power frequency converters that are installed in the same switchboard or close proximity to the Masterpact circuit breaker
- emergency generators
- high vibration marine applications such as thrusters, anchor positioning systems, etc.

General characteristics of Masterpact NW DC - DC PV

Masterpact NW DC and DC PV

Altitude

At altitudes higher than 2000 metres, the modifications in the ambient air (electrical resistance, cooling capacity) lower the following characteristics as follows:

Altitude (m)	2000	3000	4000	5000	
NW DC					
Impulse withstand voltage U_{imp} (kV)	12	10.6	9.5	8.4	
Rated insulation voltage (U_i)	1000	900	800	700	
Maximum rated operationnal voltage 50/60 Hz U_e (V)	NW DC ≤ 500 V	500	450	390	350
	NW DC 500-900 V	900	800	700	630
Rated current (A) at 40 °C	1 x I_n	0.98 x I_n	0.96 x I_n	0.94 x I_n	
NW DC PV					
Impulse withstand voltage U_{imp} (kV)	12	10.6	9.5	8.4	
Rated insulation voltage (U_i)	1000	1000	950	850	
Maximum rated operationnal DC voltage	1000	1000	950	850	
Rated current (A) at 40 °C	1 x I_n	0.98 x I_n	0.96 x I_n	0.94 x I_n	

Intermediate values may be obtained by interpolation.

Electromagnetic disturbances

Masterpact NW DC devices are protected against:

- overvoltages caused by devices that generate electromagnetic disturbances
- overvoltages caused by atmospheric disturbances or by a distribution-system outage (e.g. failure of a lighting system)
- devices emitting radio waves (radios, walkie-talkies, radar, etc.)
- electrostatic discharges produced by users.

Masterpact NW DC devices have successfully passed the electromagnetic-compatibility tests (EMC) defined by the following international standards:

- IEC 60947-2, appendix F
- IEC 60947-2, appendix B (trip units with earth-leakage function).

The above tests guarantee that:

- no nuisance tripping occurs
- tripping times are respected.

Degree of protection

Masterpact NW DC circuit breakers offer the following protection characteristics depending on the installation conditions:

- IP: degree of protection (standard IEC 60529)
- IK: protection against external mechanical impacts (standard EN 50102).

Masterpact NW DC

Circuit breaker installed in a switchboard

DE104634.eps

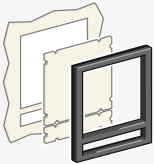

Bare circuit breaker	IP30	
Escutcheon (CDP) for fixed and drawout versions, with blanking plate	IP40	IK07

PB100776-2QR.eps



Transparent cover (CCP) for escutcheon for drawout version	IP54	IK10
--	------	------

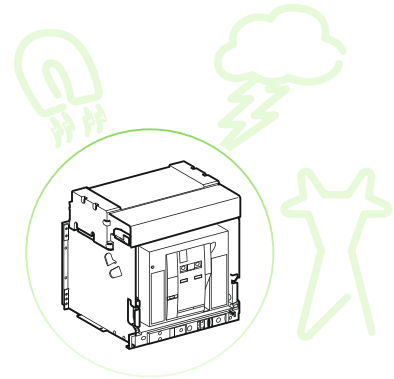
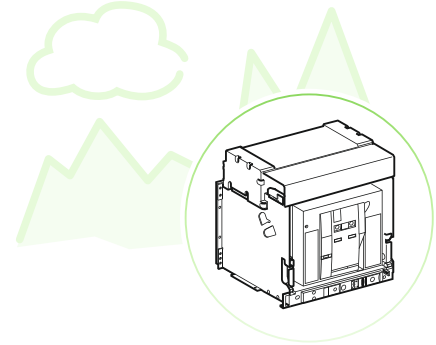

DE431752.eps



DE431753.eps

General characteristics of Masterpact NW DC - DC PV

Masterpact NW10 to NW40 DC

PB104817_09ps



NW10 DC 3P.

PB105024_42eps



NW10 DC 4P.

A

Masterpact NW DC circuit breaker

Poles coupling version	C or D (3 poles)
	E (4 poles)

Electrical characteristics as per IEC 60947-1/ 60947-2 and EN 60947-1 / 60947-2

Rated current at 40 °C / 50 °C ^[1]	I_n	(A)
Rated insulation voltage	U_i	(V)
Rated impulse withstand voltage	U_{imp}	(kV peak)
Rated operational voltage	U_e	(V DC)

Type of circuit breaker

Ultimate breaking capacity	L/R = 5 ms	I_{cu}	(kA)	V DC	500
					750
					900
	L/R = 15 ms	I_{cu}			500
					750
					900
	L/R = 30 ms	I_{cu}			500
					750
					900

Service breaking capacity	I_{cs}	% I _{cu}
Rated making capacity	I_{cm}	% I _{cu}
Short-time withstand current	I_{cw}	1 s
Utilisation category		
Breaking time		(ms)
Making time		(ms)
Suitability for isolation		
Pollution degree (as per IEC 60664-1)		

Protection against overcurrents (see trip-unit table page D-12)

Trip units	Built-in
Protection	Overloads
	Short-circuits

Durability

(O/C cycles)	Mechanical	With maintenance	
		Without maintenance	
	Electrical	Without maintenance	500 V DC
			900 V DC

Indication and control auxiliaries

Auxiliary contacts	
Voltage release	MX shunt release
	MN undervoltage release

Switch-disconnector as per IEC 60947-3 and EN 60947-3

Type of switch-disconnector

Rated making capacity	I_{cm}	(kA)
Rated short-time withstand current	I_{cw}	(kA) 1 s

Unprotected circuit breaker (500 V DC only)

Tripping by shunt trip as per IEC 60947-2

Type of unprotected circuit breaker

Ultimate breaking capacity	L/R = 6.5 ms	I_{cu}	(kA)	500 V DC
Short-time withstand current		I_{cw}	(kA)	1 s
Ultimate breaking capacity	L/R = 15 ms	I_{cu}	(kA)	500 V DC
Short-time withstand current		I_{cw}	(kA)	1 s
Service breaking capacity		I_{cs}	% I _{cu}	

Overload and short-circuit protection
 External protection relay: short-circuit protection, maximum delay: 500 ms

Installation and connections

Connection	Drawout	3P	RC	Horizontal
		4P		Vertical
Fixed		3P	RC	Horizontal
		4P		Vertical

Dimensions and weight

Dimensions H x W x D (mm) connected in series	Drawout	3P
		4P
	Fixed	3P
		4P
Weight (kg) connected in series (approximate values)	Drawout	3P
		4P
	Fixed	3P
		4P

[1] 50 °C - see the derating table for the NW40 DC.

General characteristics of Masterpact NW DC - DC PV

Masterpact NW10 to NW40 DC



NW10 DC		NW20 DC		NW40 DC	
<input type="radio"/>		<input type="radio"/>		<input type="radio"/>	
<input type="radio"/>		<input type="radio"/>		<input type="radio"/>	
1000		2000		4000	
1000		1000		1000	
12		12		12	
500/900		500/900		500/900	
N	H	N	H	N	H
85	100	85	100	85	100
-	85	-	85	-	85
-	85	-	85	-	85
35	85	35	85	35	85
-	50	-	50	-	50
-	35	-	35	-	35
25	50	25	50	25	50
-	50	-	50	-	50
-	25	-	25	-	25
100 %					
100 %					
50	85	50	85	50	85
B					
30 to 75					
< 70					
<input type="radio"/>	<input type="radio"/>	<input type="radio"/>	<input type="radio"/>	<input type="radio"/>	<input type="radio"/>
4					
<input type="radio"/>	<input type="radio"/>	<input type="radio"/>	<input type="radio"/>	<input type="radio"/>	<input type="radio"/>
-	-	-	-	-	-
<input type="radio"/>	<input type="radio"/>	<input type="radio"/>	<input type="radio"/>	<input type="radio"/>	<input type="radio"/>
20000					
10000					
8500		5000		2000	
-	2000	-	2000	-	1000
<input type="radio"/>	<input type="radio"/>	<input type="radio"/>	<input type="radio"/>	<input type="radio"/>	<input type="radio"/>
<input type="radio"/>	<input type="radio"/>	<input type="radio"/>	<input type="radio"/>	<input type="radio"/>	<input type="radio"/>
<input type="radio"/>	<input type="radio"/>	<input type="radio"/>	<input type="radio"/>	<input type="radio"/>	<input type="radio"/>
	HA		HA		HA
-	85	-	85	-	85
-	85	-	85	-	85

NW10 HADC-C 500V DC		NW20 HADC-C 500V DC		NW40 HADC-C 500V DC	
85		85		85	
85		85		85	
65		65		65	
65		65		65	
100 %					
-		-		-	
<input type="radio"/>	<input type="radio"/>	<input type="radio"/>	<input type="radio"/>	-	-
<input type="radio"/>	<input type="radio"/>	<input type="radio"/>	<input type="radio"/>	<input type="radio"/>	<input type="radio"/>
<input type="radio"/>	<input type="radio"/>	<input type="radio"/>	<input type="radio"/>	-	-
<input type="radio"/>	<input type="radio"/>	<input type="radio"/>	<input type="radio"/>	<input type="radio"/>	<input type="radio"/>
439 x 441 x 494				439 x 441 x 594	
439 x 556 x 494				439 x 556 x 594	
352 x 422 x 427				352 x 422 x 527	
352 x 537 x 427				352 x 537 x 527	
90 to 116					
125 to 146					
60 to 86					
85 to 106					

Trip-unit characteristics

Trip units for Masterpact NW DC

All Masterpact NW DC devices are equipped with a Micrologic 1.0 DC control unit.

A

PB101139-32R.eps

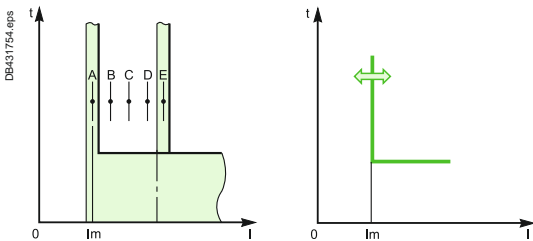

Magnetic pick-up value.

Protection using the Micrologic 1.0 DC control unit

Masterpact NW DC circuit breakers use Micrologic 1.0 DC control units. These interchangeable units with instantaneous thresholds, operating with electromagnetic sensors, can be adjusted on site.

The circuit breakers can be used with the three versions of sensors, defined by their setting range.

Type of sensor	1250/2500 A	2500/5400 A	5000/11000 A
Masterpact NW10 DC	<input checked="" type="radio"/>	<input type="radio"/>	<input type="radio"/>
Masterpact NW20 DC	<input type="radio"/>	<input checked="" type="radio"/>	<input type="radio"/>
Masterpact NW40 DC	<input type="radio"/>	<input type="radio"/>	<input checked="" type="radio"/>

Adjustments

Settings for Masterpact NW DC circuit breakers may be accessed from the front, with the switchboard door open.

- Settings are made for the input (+ pole) and the output (- pole).
- The setting range comprises eleven positions, plus five preferential settings marked **A, B, C, D** and **E**.
- The setting values for the two corresponding sensors must be identical.

DB431755.eps

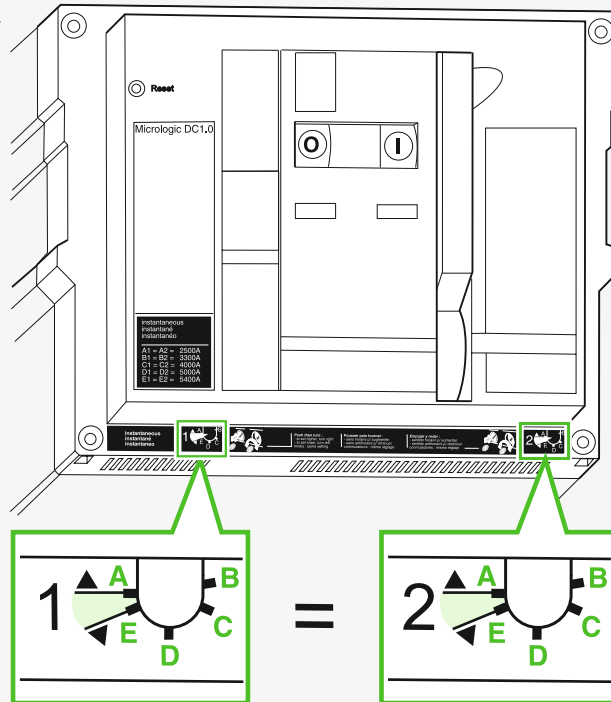

Two identical settings.

Setting values for magnetic pick-up I_m

Settings marked A, B, C, D and E

Sensor versions	Minimum				Maximum
	Settings A1 and A2	Settings B1 and B2	Settings C1 and C2	Settings D1 and D2	Settings E1 and E2
1250/2500	1250 A	1500 A	1600 A	2000 A	2500 A
2500/5400	2500 A	3300 A	4000 A	5000 A	5400 A
5000/11000	5000 A	8000 A	10000 A	11000 A	11000 A
Tolerances	±8 %	±10 %	±10 %	±10 %	±10 %

instantaneous
instantané
instantaneo :

A₁ = A₂ = 2500A
B₁ = B₂ = 3300A
C₁ = C₂ = 4000A
D₁ = D₂ = 5000A
E₁ = E₂ = 5400A

instantaneous
instantané
instantaneo :

A₁ = A₂ = 5000A
B₁ = B₂ = 8000A
C₁ = C₂ = 10000A
D₁ = D₂ = 11000A
E₁ = E₂ = 11000A

Intermediate settings

It is possible to set eleven other (unmarked) intermediate values.

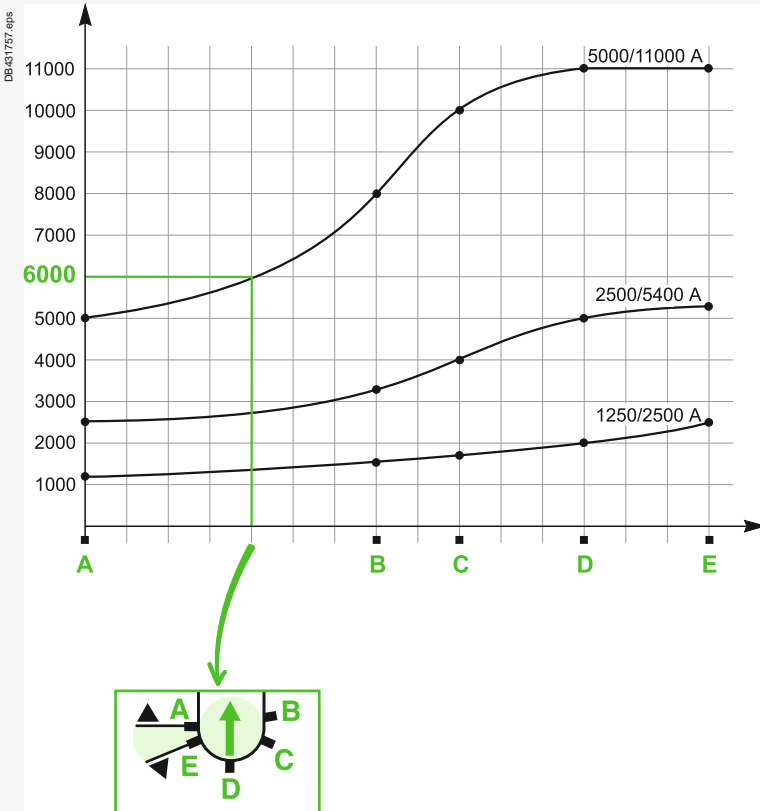

Switch-disconnectors for PV application

Masterpact NW HADCD-PV

PE11349_32.eps



Masterpact NW20 HADCD-PV.

A

DB416372.eps

Masterpact NW20 HADCD-PV

Ui 1000V Uimp 12kV

Ue 1000 V \approx 3P in series

Icw 85kA/1s

Icm 85kA

IEC 60947-3

Ith 2000A 55°C

Ue (V) Ie (A)

DC22A 1000 2000

Masterpact NW20 HADCD-PV rating plate.

DB416460.eps

Masterpact NW40 HADCD-PV

Ui 1000V Uimp 12kV

Ue 1000 V \approx 3P in series

Icw 85kA/1s

Icm 85kA

IEC 60947-3

Ith 4000A 45°C

Ue (V) Ie (A)

DC22A 1000 4000

Masterpact NW40 HADCD-PV rating plate.

Masterpact NW HADCD-PV switch-disconnectors for PV application		NW20 HADCD-PV	NW40 HADCD-PV		
Poles coupling version	D (3 poles)	⊙	⊙		
Electrical characteristics as per IEC 60947-1 / 60947-3 and EN 60947-1 / 60947-3					
Rated current at 40/45 °C	In (A)	2000	4000		
Rated insulation voltage	Ui (V)	1000	1000		
Rated impulse withstand voltage	Uimp (kV peak)	12	12		
Rated operational voltage	Ue (V DC)	1000 [1]	1000 [1]		
Switch-disconnector as per IEC 60947-3 and EN 60947-3					
Rated making capacity	Icm (kA)	85	85		
Rated short-time withstand current	Icw (kA/1 s)	85	85		
Utilization category		DC-22A	DC-22A		
Durability					
(O/C cycles)	Mechanical with maintenance	20000	20000		
	without maintenance	10000	10000		
	Electrical without maintenance	2000	1000		
	1000 V DC L/R = 2 ms				
Installation and connections					
Connection	Fixed	rear connections	Vertical	⊙	⊙
			Horizontal	⊙	-
	Drawout	rear connections	Vertical	⊙	⊙
			Horizontal	⊙	-
Dimensions and weight					
Dimensions	Fixed	3P	352 x 422 x 427	352 x 422 x 527	
H x W x D (mm) with the series connection	Drawout	3P	439 x 441 x 494	439 x 441 x 594	
Weight (kg)	Fixed	3P	60 to 86		
with the series connection (approximate values)	Drawout	3P	90 to 116		

All the accessories of the standard NW HADC switch-disconnectors can be used.

[1] NW HADCD-PV switch-disconnectors for PV applications are designed and qualified to break the rated or the fault current under 1000 V DC with all the 3 poles in series and this is a mandatory condition whatever the type of fault. This comes to say that the PV systems using these switch-disconnectors must be isolated systems from the earth and that the double fault situation (A and D or C and E on the diagram below) must be absolutely avoided : insulation monitoring devices shall detect the first fault and the staff shall look for this first fault and clear it with no delay. These switch-disconnectors cannot be used in grounded systems as in this situation they may be expected to break the current under the full voltage (1000 V DC) with only 1 pole or 2 poles in series. These devices are not designed for that purpose and could sustain irremediable damage if used to break in these conditions.

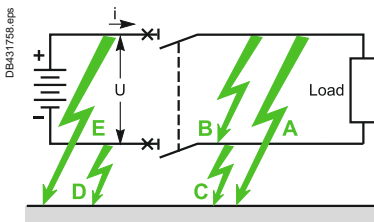

Isolated system.

Switch-disconnectors for PV application

Masterpact NW HADCD-PV - Connections and safety clearances



Fixed version, vertical rear connections

NW20 HADCD-PV

NW40 HADCD-PV

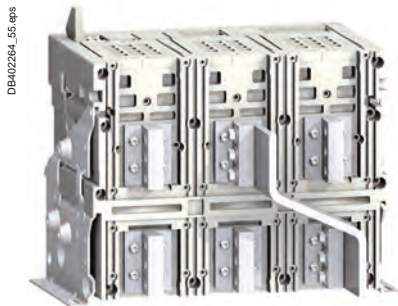

Safety clearances

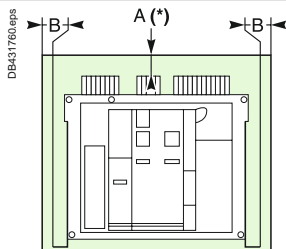
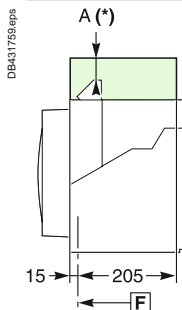

	Insulated parts	Metal parts	Energised parts
A	0	0	100
B	0	0	60

F: Datum.
A(*) An overhead clearance of 110 mm is required to remove the arc chutes.
 An overhead clearance of 20 mm is required to remove the terminal block.

Drawout version, vertical rear connections

NW20 HADCD-PV

NW40 HADCD-PV

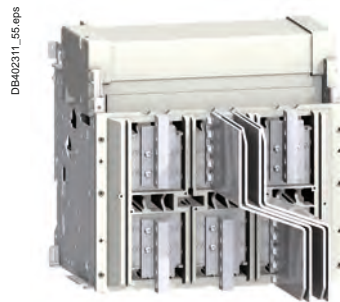

Safety clearances

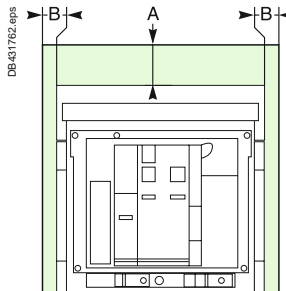
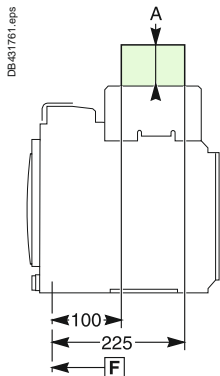

	Insulated parts	Metal parts	Energised parts
A	0	0	0
B	0	0	60

F: Datum.

Panorama of electrical and mechanical accessories

Masterpact NW10 to NW40 DC

All Masterpact NW DC devices exist in Circuit breaker (equipped with Micrologic DC 1.0 control unit) and switch-disconnector versions. All auxiliaries are common from 1000 to 4000 A.

A

- A** OFF pushbutton.
- B** ON pushbutton.
- C** Closing mechanism charging handle.
- D** Operation counter.
- E** Operating mechanism charged and "ready to close" indication:
 - spring charged
 - spring discharged.

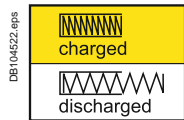

- F** Main contact position indication:
 - ON
 - OFF.

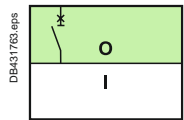

- G** Fault trip indication and reset button.
- H** Micrologic 1.0 DC control unit.
- I** Racking interlock.
- J** Racking-handle storage.
- K** Shutter position indication and locking.
- L** "Connected / test / disconnected" position indication.
- M** Racking-handle port.
- N** Reset pushbutton.
- O** Padlock locking.
- P** Keylock locking.

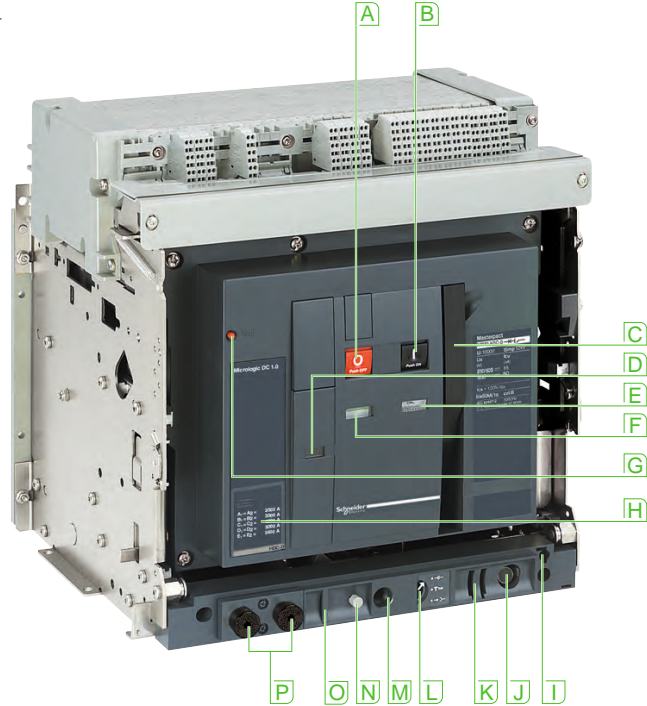

Vertical rear connection.

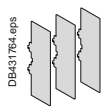

Circuit breakers and switch-disconnectors

- Masterpact NW DC exists in fixed and withdrawable versions:
 - circuit breaker equipped with Micrologic 1.0 DC control unit
 - switch-disconnector without the control unit.

Common auxiliaries from 1000 to 4000 A

- All auxiliaries are:
- accessible from the front in a compartment isolated from the power circuits
 - secured by a single screw
 - no adjustments
 - adaptable on site.

Communication

Circuit breaker or switch-disconnector integration in a supervision system requires the COM option. Masterpact uses the Modbus communication protocol compatible with ION-E electrical engineering expert system software. An external gateway is available for communication with other networks (Profibus, Ethernet, etc.).

Connections

- Rear vertical connection in standard.
- Possibility of conversion to horizontal connection by turning the connectors on the site by the customer (except for the NW40).
- Prefabricated series connections.
- Safety shutters, shutter locking blocks.
- Optional accessories:
 - interphase barriers
 - shutter position indication and locking.

Panorama of electrical and mechanical accessories

Masterpact NW10 to NW40 DC

Locking

- Pushbutton locking by padlockable transparent cover.
- OFF-position locking by padlock or keylock.
- Chassis locking:
 - in disconnected position by keylock
 - in connected, disconnected and test positions.
- Door interlock (inhibits door opening with breaker in connected position).
- Racking interlock (inhibits racking with door open).
- Racking interlock between crank and OFF pushbutton.
- Automatic spring discharge before breaker removal.
- Mismatch protection.



PB104387A32.eps



PB104386A32.eps



PB1007903DR_SE1.eps

Locking in disconnected position by keylock or padlock.

Door interlock (inhibits door opening with breaker in connected position).



Indication contacts

- Standard or low-level contacts:
 - ON/OFF indication (OF)
 - "fault-trip" indication (SDE)
 - carriage switches for connected (CE), disconnected (CD) and test (CT) positions.

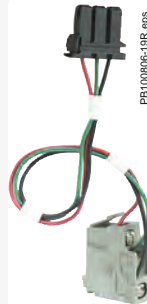

PB100806-19R.eps

OF contact (microswitch).



PB100807-12R.eps

OF contact (rotary).



PB100820-19R.eps

SDE contact.



PB100816-19R.eps

Combined contact (connected/closed).

Remote operation

- Remote ON/OFF:
 - gear motor
 - XF closing or MX opening voltage releases
 - PF ready-to-close contact
 - options:
 - RAR automatic or Res electrical remote reset
 - BPFE electrical closing pushbutton.
- Remote tripping function:
 - MN voltage release:
 - standard
 - adjustable or non-adjustable delay
 - or 2nd MX voltage release.

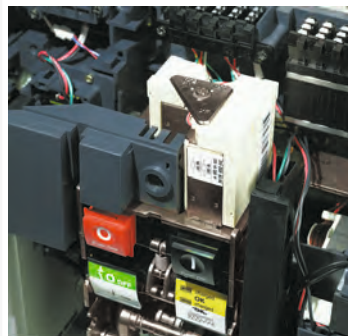

PB104349A455.eps

Remote ON/OFF.



PB100809-22R.eps

Gear motor.



PB100809-11R.eps

Voltage releases (MX and XF).



PB100816-11R.eps

PF ready-to-close contact.

Accessories

- Auxiliary terminal shield.
- Operation counter.
- Escutcheon.
- Transparent cover for escutcheon.
- Escutcheon blanking plate.



Operation counter.

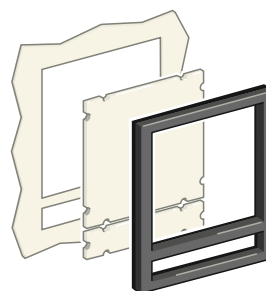

DB104524.eps

Escutcheon with blanking plate.



PB100776-29R.eps

Transparent cover.

Connection

Overview of solutions

Two types of connection are available: vertical connection is standard however the connectors can be rotated for on-site conversion to horizontal connection (except for NW40).

Rear connection fixed device

Masterpact NW DC

Vertical rear connection

PB106026.eps

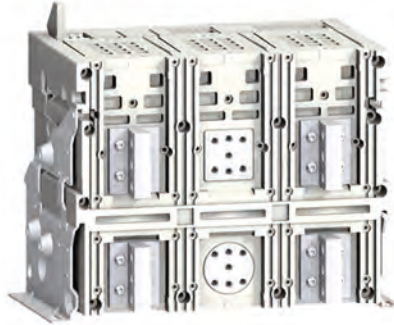

Horizontal rear connection

PB106025.eps

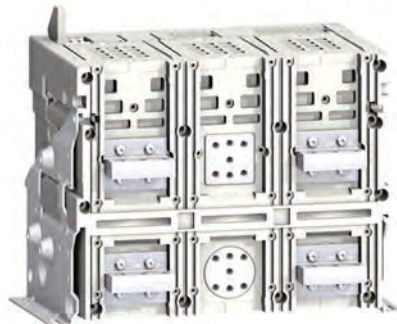

A

Rear connection withdrawable device

Masterpact NW DC

Horizontal rear connection

DB402291_59.eps



DB402303_59.eps

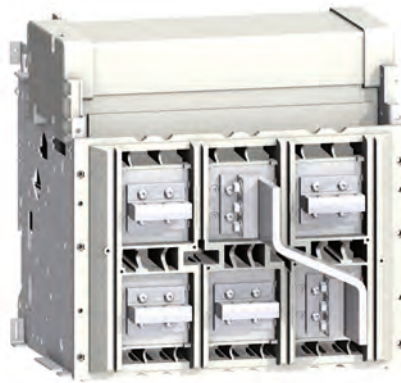

Vertical rear connection

PB104920_59.eps



DB402323_59.eps



Electrical and mechanical accessories

Masterpact NW10 to NW40 DC

A

Locking on the device

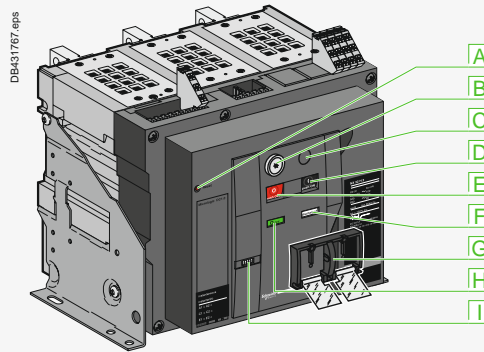

- A** Fault trip indication and reset button.
- B** OFF position locking.
- C** Electrical closing pushbutton.
- D** ON pushbutton.
- E** OFF pushbutton.
- F** Operating mechanism charged and "ready to close" indication.
- G** Pushbutton locking.
- H** Main contact position indication.
- I** Operation counter.



Access to pushbuttons protected by transparent cover.



Pushbutton locking using a padlock.



OFF position locking using a padlock.



OFF position locking using a keylock.

Pushbutton locking VBP

The transparent cover blocks access to the pushbuttons used to open and close the device.

It is possible to independently lock the opening button and the closing button. The locking device is often combined with a remote operating mechanism.

The pushbuttons may be locked using either:

- three padlocks (not supplied)
- lead seal
- two screws.

Device locking in the OFF position VCPO - by padlocks - VSPO - by keylocks

The circuit breaker is locked in the OFF position by physically maintaining the opening pushbutton pressed down:

- using padlocks (one to three padlocks, not supplied)
- using keylocks (one or two different keylocks, supplied).

Keys may be removed only when locking is effective (Profalux or Ronis type locks).

The keylocks are available in any of the following configurations:

- one keylock
- one keylock mounted on the device + one identical keylock supplied separately for interlocking with another device
- two different key locks for double locking.

Profalux and Ronis keylocks are compatible with each other.

A locking kit (without locks) is available for installation of one or two keylocks (Ronis, Profalux, Kirk or Castell).

Accessory-compatibility

3 padlocks and/or 2 keylocks.

Cable-type door interlock IPA

This option prevents door opening when the circuit breaker is closed and prevents circuit breaker closing when the door is open.

For this, a special plate associated with a lock and a cable is mounted on the right side of the circuit breaker.

With this interlock installed, the source changeover function cannot be implemented.

This option is identical for fixed or drawout versions.

Electrical and mechanical accessories

Masterpact NW10 to NW40 DC

Locking on the chassis

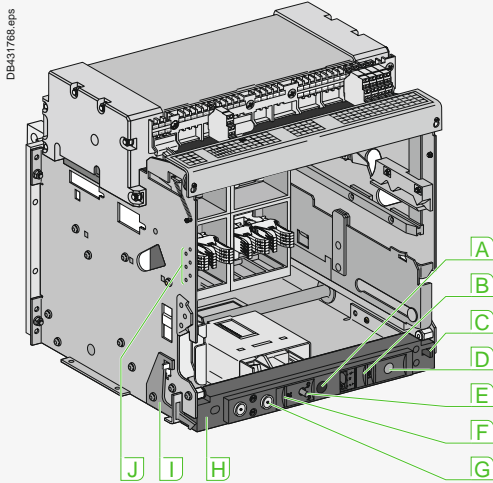

- A** Racking-handle port.
- B** "Connected/test/disconnected" position indication.
- C** Racking interlock.
- D** Racking-handle storage.
- E** Reset pushbutton.
- F** Padlock locking.
- G** Keylock locking.
- H** Chassis front plate (accessible with cubicle door closed).
- I** "Disconnected" position door interlock.
- J** Mismatch protection.

"Disconnected" position locking

By padlocks (standard) or keylocks (VSPD option)

Mounted on the chassis and accessible with the door closed, these devices lock the circuit breaker in the "disconnected" position in two manners:

- using padlocks (standard), up to three padlocks (not supplied)
- using keylocks (optional), one or two different keylocks are available.

Profalux and Ronis keylocks are available in different options:

- one keylock
- two different keylocks for double locking
- one (or two) keylocks mounted on the chassis + one (or two) identical keylocks supplied separately for interlocking with another device.

A locking kit (without locks) is available for installation of one or two keylocks (Ronis, Profalux, Kirk or Castell).

Connected, "disconnected" and "test" position locking

The "connected", "disconnected" and "test" positions are shown by an indicator and are mechanically indexed. The exact position is obtained when the racking handle blocks. A release button is used to free it.

As standard, the circuit breaker can be locked only in "disconnected" position. On request, the locking system may be modified to lock the circuit breaker in any of the three positions "connected", "disconnected" or "test".

Door interlock catch VPEC

Mounted on the right or left-hand side of the chassis, this device inhibits opening of the cubicle door when the circuit breaker is in "connected" or "test" position. If the breaker is put in the "connected" position with the door open, the door may be closed without having to disconnect the circuit breaker.

Racking interlock VPOC

This device prevents insertion of the racking handle when the cubicle door is open.

Cable-type door interlock IPA

This option is identical for fixed and drawout versions.

Racking interlock between crank and OFF pushbutton IBPO for NW DC

This option makes it necessary to press the OFF pushbutton in order to insert the racking handle and holds the device open until the handle is removed.

Automatic spring discharge before breaker removal DAE for NW DC

This option discharges the springs before the breaker is removed from the chassis.

Mismatch protection VDC

Mismatch protection ensures that a circuit breaker is installed only in a chassis with compatible characteristics. It is made up of two parts (one on the chassis and one on the circuit breaker) offering twenty different combinations that the user may select.



Racking interlock.



Mismatch protection.



PB104737A_005

PB100615-32R_SE_005

Electrical and mechanical accessories

Masterpact NW10 to NW40 DC

Indication contacts are available:

- in the standard version for relay applications
- in a low-level version for control of PLCs and electronic circuits.

A

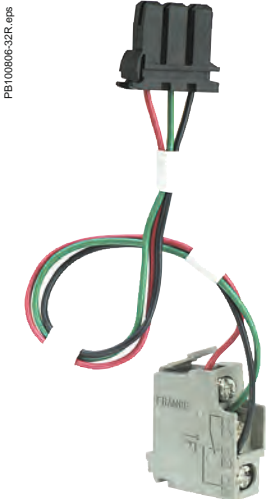

ON/OFF indication contacts OF (microswitch type).



ON/OFF indication contacts OF (rotary type).

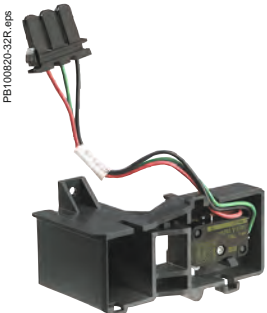

Additional "fault-trip" indication contacts SDE.

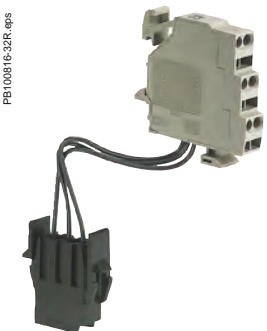

Combined contacts.

Indication contacts

ON/OFF indication contacts OF

Rotary type changeover contacts directly driven by the mechanism. These contacts trip when the minimum isolation distance between the main Circuit breaker contacts is reached.

OF			
Supplied as standard			4
Maximum number			12
Breaking capacity (A) p.f.: 0.3 AC12/DC12	Standard	V AC 240/380	10/6 ^[1]
		480	10/6 ^[1]
		690	6
		V DC 24/48	10/6 ^[1]
		125	10/6 ^[1]
		250	3
	Low-level		minimum load: 2 mA/15 V
		V AC 24/48	6
		240	6
		380	3
		V DC 24/48	6
		125	6
		250	3

[1] Standard contacts: 10 A; optional contacts: 6 A.

"Fault-trip" indication contacts SDE

Circuit breaker tripping due to a fault is signalled by:

- a red mechanical fault indicator (reset)
- one changeover contact SDE.

Following tripping, the mechanical indicator must be reset before the circuit breaker may be closed. One SDE is supplied as standard. An optimal SDE may be added. This latter is incompatible with the electrical reset after fault-trip option (Res).

SDE			
Supplied as standard			1
Maximum number			2
Breaking capacity (A) p.f.: 0.3 AC12/DC12	Standard	V AC 240/380	6
		480	2
		V DC 24/48	3
		125	0.3
		250	0.15
	Low-level		minimum load: 2 mA/15 V
		V AC 24/48	3
		240	3
		380	3
		V DC 24/48	3
		125	0.3
		250	0.15

Electrical and mechanical accessories

Masterpact NW10 to NW40 DC

Combined “connected/closed” contacts EF

The contact combines the “device connected” and the “device closed” information to produce the “circuit closed” information. Supplied as an option for Masterpact NW DC, it is mounted in place of the connector of an additional OF contact.

EF					
Maximum number			8		
Breaking capacity (A) p.f.: 0.3 AC12/DC12	Standard	V AC	240/380	6	
			480	6	
			690	6	
		V DC	24/48	2.5	
			125	0.8	
			250	0.3	
	Low-level	V AC	24/48	5	
			240	5	
			380	5	
		V DC	24/48	2.5	
			125	0.8	
			250	0.3	
			minimum load: 100 mA/24 V		
			minimum load: 2 mA/15 V		



CE, CD and CT “connected/disconnected/test” position carriage switches.

PB100817-32R-eps



“Connected”, “disconnected” and “test” position carriage switches

Three series of optional auxiliary contacts are available for the chassis:

- changeover contacts to indicate the “connected” position CE
- changeover contacts to indicate the “disconnected” position CD. This position is indicated when the required clearance for isolation of the power and auxiliary circuits is reached.
- changeover contacts to indicate the “test” position CT. In this position, the power circuits are disconnected and the auxiliary circuits are connected.

Additional actuators

A set of additional actuators may be installed on the chassis to change the functions of the carriage switches.

Contacts				CE	CD	CT
Maximum number	Standard with additional actuators			3	3	3
				9	0	0
				6	3	0
				6	0	3
				3	6	0
Breaking capacity (A) p.f.: 0.3 AC12/DC12	Standard	V AC	240	8		
			380	8		
			480	8		
			690	6		
			V DC	24/48	2.5	
				125	0.8	
	250	0.3				
	Low-level	V AC	24/48	5		
			240	5		
			380	5		
		V DC	24/48	2.5		
			125	0.8		
			250	0.3		
			minimum load: 100 mA/24 V			
minimum load: 2 mA/15 V						

Electrical and mechanical accessories

Masterpact NW10 to NW40 DC

Two solutions are available for remote operation of Masterpact devices:

- a point-to-point solution
- a bus solution with the COM communication option.

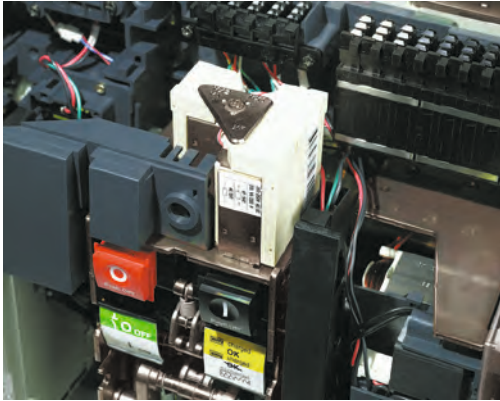

A

Remote operation: remote ON / OFF

The remote ON / OFF function is used to remotely open and close the circuit breaker. It is made up of:

- an electric motor MCH equipped with a "springs charged" limit switch contact CH
- two voltage releases:
 - a closing release XF
 - an opening release MX.

Optionally, other functions may be added:

- a "ready to close" contact PF
- an electrical closing pushbutton BPFE
- remote RES following a fault.

A remote-operation function is generally combined with:

- device ON / OFF indication OF
- "fault-trip" indication SDE.

Note:

An opening order always takes priority over a closing order. If opening and closing orders occur simultaneously, the mechanism discharges without any movement of the main contacts. The circuit breaker remains in the open position (OFF).

In the event of maintained opening and closing orders, the standard mechanism provides an anti-pumping function by blocking the main contacts in open position.

Anti-pumping function. After fault tripping or intentional opening using the manual or electrical controls, the closing order must first be discontinued, then reactivated to close the circuit breaker.

When the automatic reset after fault trip (RAR) option is installed, to avoid pumping following a fault trip, the automatic control system must take into account the information supplied by the circuit breaker before issuing a new closing order or blocking the circuit breaker in the open position. (information on type of fault: overload, short time delay, earth-leakage fault, fault vigi or short-circuit, etc.)

Wiring diagram of a point-to-point remote ON / OFF function

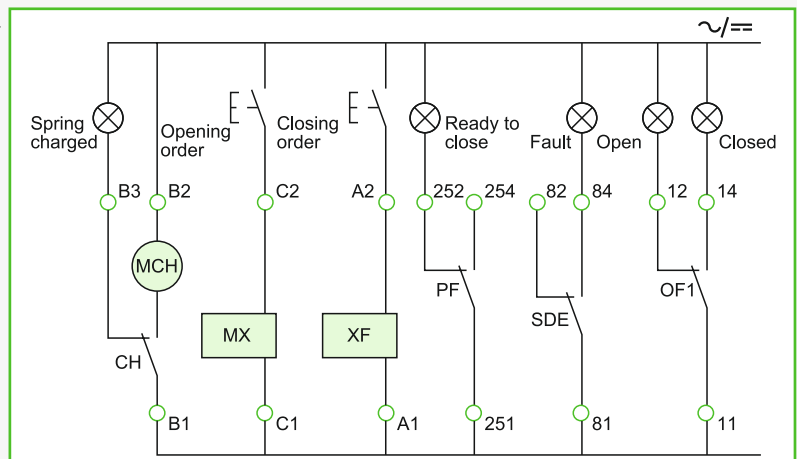

Wiring diagram of a bus-type remote ON / OFF function

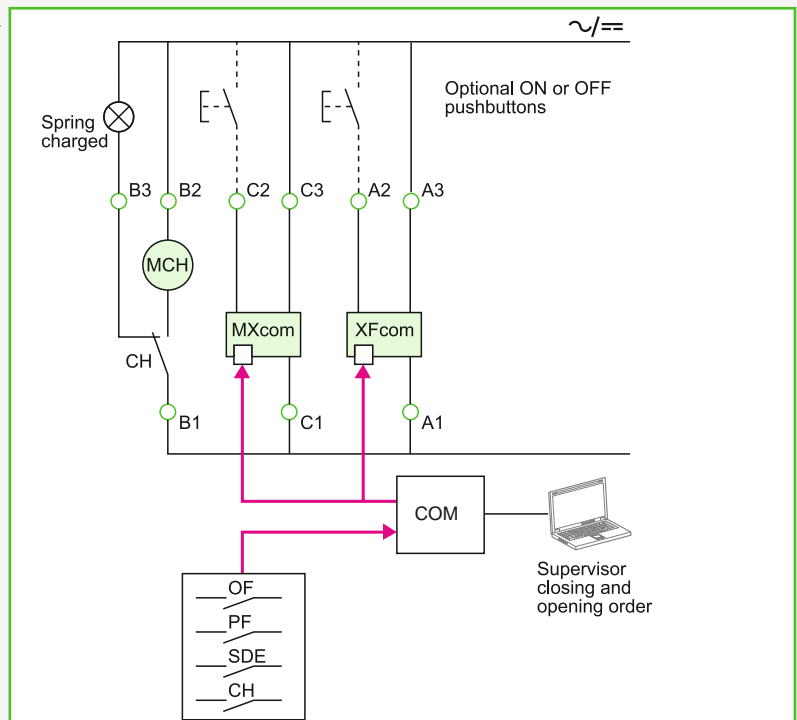

Note:

MX communicating releases are of the impulse type only and cannot be used to lock a circuit breaker in OFF position. For locking in OFF position, use the remote tripping function (2nd MX or MN).

When Mx or XF communicating releases are used, the third wire (C3, A3) must be connected even if the communication module is not installed. When the control voltage (C3-C1 or A3-A1) is applied to the MX or XF releases, it is necessary to wait 1.5 seconds before issuing an order. consequently, it is advised to use standrad MX or XF releases for applications such as source-changeover systems.

Electrical and mechanical accessories

Masterpact NW10 to NW40 DC

Electric motor MCH

The electric motor automatically charges and recharges the spring mechanism when the circuit breaker is closed. Instantaneous reclosing of the breaker is thus possible following opening. The spring-mechanism charging handle is used only as a backup if auxiliary power is absent.

The electric motor (MCH) is equipped as standard with a limit switch contact (CH) that signals the "charged" position of the mechanism (springs charged).

Characteristics

Power supply	V AC 50/60 Hz	48/60 - 100/130 - 200/240 - 277 - 380/415 - 400/440 - 480
	V DC	24/30 - 48/60 - 100/125 - 200/250
Operating threshold	0.85 to 1.1 Un	
Consumption (VA or W)	180	
Motor overcurrent	2 to 3 In for 0.1 s	
Charging time	maximum 4 seconds	
Operating frequency	maximum 3 cycles per minute	
CH contact	10 A at 240 V	

Voltage releases XF and MX

Their supply can be maintained or automatically disconnected.

Closing release XF

The XF release remotely closes the circuit breaker if the spring mechanism is charged.

Opening release MX

The MX release instantaneously opens the circuit breaker when energised, the minimum duration of the pulse operating order must be 200 ms. The MX release locks the circuit breaker in OFF position if the order is maintained (except for MX "communicating" releases).

Note: whether the operating order is maintained or automatically disconnected (pulse-type), XF or MX "communicating" releases ("bus" solution with "COM" communication option) always have an impulse-type action (see diagram).

Characteristics	XF	MX
Power supply	V AC 50/60 Hz	24 - 48 - 100/130 - 200/250 - 277 - 380/480
	V DC	12 - 24/30 - 48/60 - 100/130 - 200/250
Operating threshold	0.85 to 1.1 Un	
Consumption (VA or W)	pick-up: 200 (during 200 ms) hold: 4.5	pick-up: 200 (during 200 ms) hold: 4.5
Circuit breaker response time at Un	70 ms ±10 (NW DC ≤ 4000 A) 80 ms ±10 (NW DC > 4000 A)	50 ms ±10 (NW DC)

"Ready to close" contact PF

The "ready to close" position of the circuit breaker is indicated by a mechanical indicator and a PF changeover contact. This signal indicates that all the following are valid:

- the circuit breaker is in the OFF position
- the spring mechanism is charged
- a maintained opening order is not present:
- MX energised
- fault trip
- remote tripping second MX or MN
- device not completely racked in
- device locked in OFF position
- device interlocked with a second device.

Characteristics

Supplied as standard			-	
Maximum number			1	
Breaking capacity p.f.: 0.3 AC12/DC12	Standard	V AC	240/380	
			480	
		690		
	V DC	24/48		
		125		
		250		
	Low-level			minimum load: 2 mA/15 V
	V AC	24/48	3	
		240	3	
		380	3	
V DC	24/48	3		
	125	0.3		
	250	0.15		



Electric motor MCH for Masterpact NW DC.

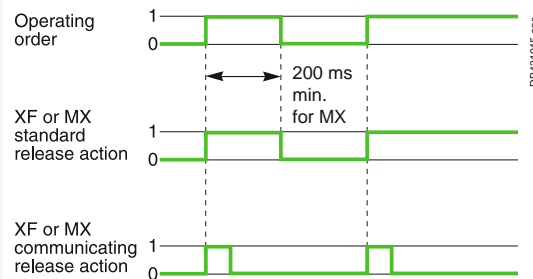

XF and MX voltage releases.



"Ready to close" contacts PF.

PB100808-32R.eps



DB431945.eps

PB100809-16R.eps

PB100810-16R.eps

Electrical and mechanical accessories

Masterpact NW10 to NW40 DC



Electrical closing pushbutton BPFE

Located on the front panel, this pushbutton carries out electrical closing of the circuit breaker. It is generally associated with the transparent cover that protects access to the closing pushbutton.

Electrical closing via the BPFE pushbutton takes into account all the safety functions that are part of the control/monitoring system of the installation.

The BPFE connects to the closing release XF in place of the COM module.

The COM module is incompatible with this option.

Different types of voltage exist and the XF electromagnet is compulsory if the BPFE option is selected.

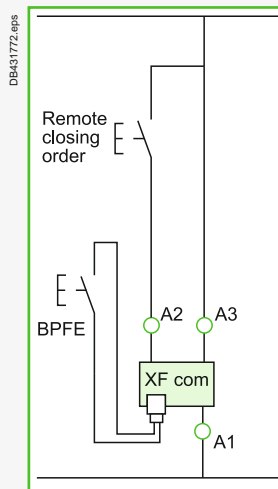

Remote reset after fault trip

Electrical reset after fault trip RES

Following tripping, this function resets the "fault trip" indication contacts SDE and the mechanical indicator and enables circuit breaker closing.

Power supply: 110 / 130 V AC and 200 / 240 V AC.

The use of XF closing release is compulsory with this option.

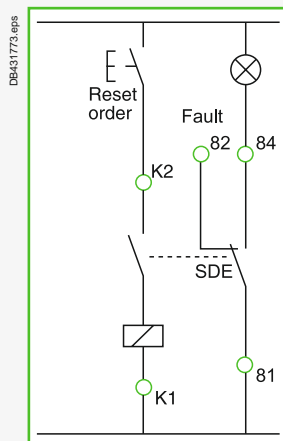

Automatic reset after fault trip RAR

Following tripping, a reset of the mechanical indicator (reset button) is no longer required to enable Circuit breaker closing. The mechanical (reset button) and electrical SDE indications remain in fault position until the reset button is pressed. The use of XF closing release is compulsory with this option.

Electrical and mechanical accessories

Masterpact NW10 to NW40 DC

Remote operation: remote tripping

This function opens the circuit breaker via an electrical order. It is made up of:

- a shunt release second MX
- or an undervoltage release MN
- or a delayed undervoltage release MNR: (MN + delay unit).

These releases (2nd MX or MN) cannot be operated by the communication bus. The delay unit, installed outside the circuit breaker, may be disabled by an emergency OFF button to obtain instantaneous opening of the circuit breaker.

Wiring diagram for the remote-tripping function

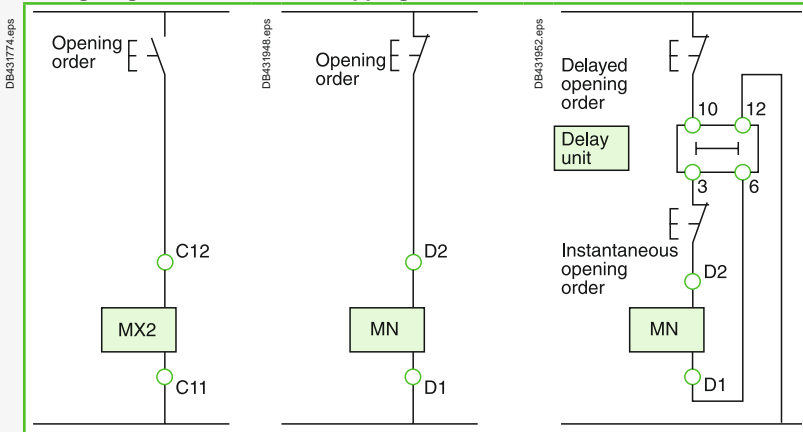

Voltage releases second MX

When energised, the MX voltage release instantaneously opens the circuit breaker. A continuous supply of power to the second MX locks the circuit breaker in the OFF position.

Characteristics		
Power supply	V AC 50/60 Hz	24 - 48 - 100/130 - 200/250 - 277 - 380/480
	V DC	24/30 - 48/60 - 100/130 - 200/250
Operating threshold		0.7 to 1.1 Un
Permanent locking function		0.85 to 1.1 Un
Consumption (VA or W)		pick-up: 200 (during 80 ms) hold: 4.5
Circuit breaker response time at Un		50 ms ±10

Instantaneous voltage releases MN

The MN release instantaneously opens the circuit breaker when its supply voltage drops to a value between 35 % and 70 % of its rated voltage. If there is no supply on the release, it is impossible to close the circuit breaker, either manually or electrically. Any attempt to close the circuit breaker has no effect on the main contacts. Circuit breaker closing is enabled again when the supply voltage of the release returns to 85 % of its rated value.

Characteristics		
Power supply	V AC 50/60 Hz	24 - 48 - 100/130 - 200/250 - 380/480
	V DC	12 - 24/30 - 48/60 - 100/130 - 200/250
Operating threshold	opening	0.35 to 0.7 Un
	closing	0.85 Un
Consumption (VA or W)		pick-up: 200 (during 200 ms) hold: 4.5
MN consumption with delay unit		pick-up: 200 (during 200 ms) hold: 4.5
Circuit breaker response time at Un		90 ms ±5

MN delay units

To eliminate Circuit breaker nuisance tripping during short voltage dips, operation of the MN release can be delayed. This function is achieved by adding an external delay unit in the MN voltage-release circuit. Two versions are available, adjustable and non-adjustable.

Characteristics		
Power supply	non-adjustable	100/130 - 200/250
VAC 50-60 Hz/DC	adjustable	48/60 - 100/130 - 200/250 - 380/480
Operating threshold	opening	0.35 to 0.7 Un
	closing	0.85 Un
Consumption of delay unit alone (VA or W)		pick-up: 200 (during 200 ms) hold: 4.5
Circuit breaker response time at Un	non-adjustable	0.25 s
	adjustable	0.5 s - 0.9 s - 1.5 s - 3 s

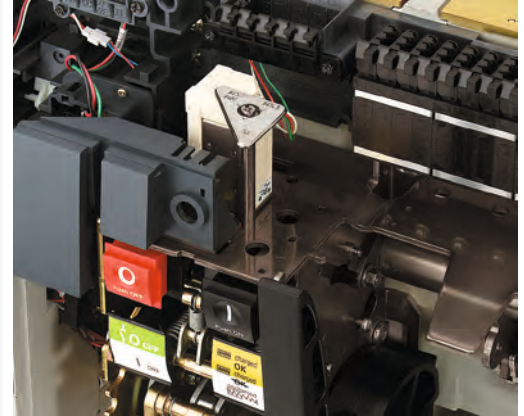

PB104060A-6BR.eps



MX or MN voltage release.

PB100800-1RF.eps

Electrical and mechanical accessories

Masterpact NW10 to NW40 DC

A

DB124953.eps



Shields, blanking plates, counters

Auxiliary terminal shield CB

Optional equipment mounted on the chassis, the shield prevents access to the terminal block of the electrical auxiliaries.

PB104342-32F.eps



Operation counter CDM

The operation counter sums the number of operating cycles and is visible on the front panel. It is compatible with manual and electrical control functions.

DB41775.eps

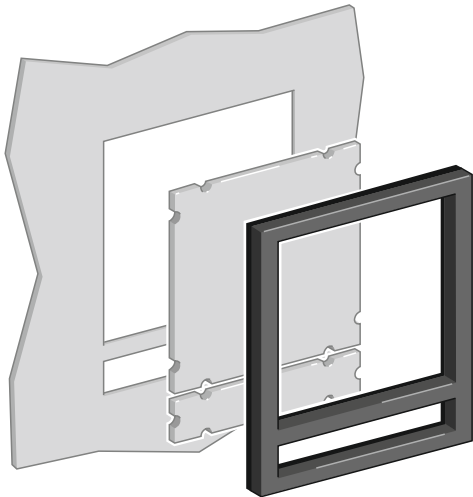

Escutcheon CDP

Optional equipment mounted on the door of the cubicle, the escutcheon increases the degree of protection to IP 40 (circuit breaker installed free standing: IP30) . It is available in fixed and drawout versions.

Blanking plate OP for escutcheon

Used with the escutcheon, this option closes off the door cut-out of a cubicle not yet equipped with a device. It may be used with the escutcheon for both fixed and drawout devices.

Transparent cover CCP for escutcheon

Optional equipment mounted on the escutcheon, the cover is hinged and secured by a screw. It increases the degree of protection to IP 54, IK10. It adapts to drawout devices.

Escutcheon CDP with blanking plate.

PB100776-42R.eps



Transparent cover CCP for escutcheon.

DB41776.eps

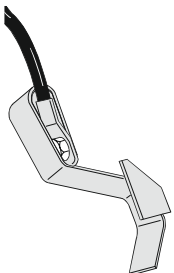

Grounding kit KMT

This option allows the grounding of the breaker mechanism while the front cover is removed. The grounding is made via the chassis for the drawout version and via the fixation side plate for the fixed version.

Grounding kit KMT.

Installation recommendations

Compact NSX100 to NSX1200 DC

Installation in switchboards.....	B-2
Power connections.....	B-3
Safety clearances, minimum distances and insulation of live parts.....	B-5
Temperature derating	B-6
Characteristics of circuit breakers with parallel connection of poles.....	B-7

Compact NSX DC PV

Safety clearances and minimum distances	B-10
Temperature derating	B-12
Temperature derating - Power dissipation / Resistance	B-13

Masterpact NW10 to NW40 DC - DC PV

Installation in switchboard	B-14
Door interlock.....	B-15
Cable-type door interlock - Connection of MN, MX and XF voltage releases	B-16
Power connection	B-17
Busbar sizing	B-20
Temperature derating - Power dissipation and input/output resistance.....	B-21



Other chapters

Presentation.....	2
Functions and characteristics	A-1
Dimensions and connection	C-1
Electrical diagrams	D-1
Additional characteristics	E-1
Catalogue numbers and order form	F-1

Compact NSX100 to NSX1200 DC Installation in switchboards

B

Possible mounting positions

For fixed or withdrawable circuit breakers

Fig. A

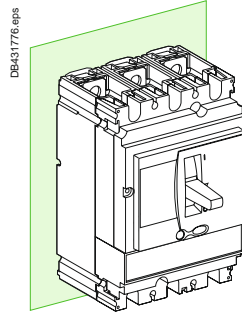

Fig. B

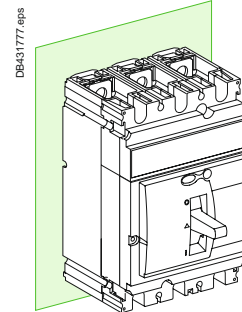

Fig. C

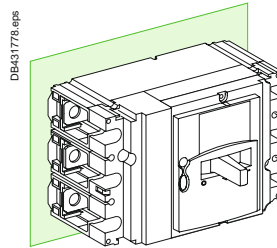

Fig. D

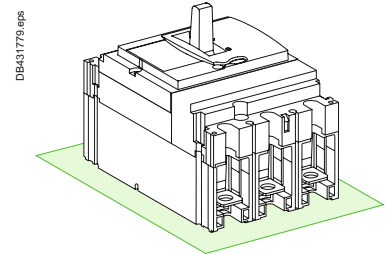
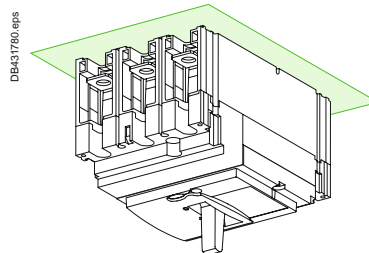

Fig. E



Possible supports

For fixed or withdrawable circuit breakers

On a plain mounting plate

On a slotted mounting plate

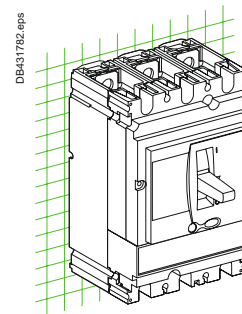
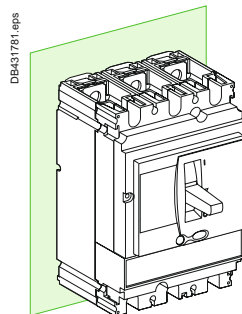

On rails

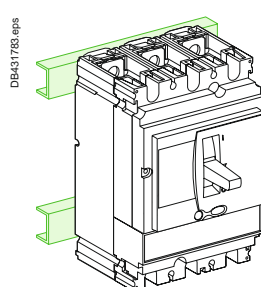

Installation recommendations

Compact NSX100 to NSX1200 DC

Power connections

Electrodynamic forces on the conductors

The circuit breakers can be connected with copper, tinned copper or tinned aluminum conductors (rigid or flexible bars, cables). In the event of a short-circuit, electrodynamic forces will be exerted on the conductors. They must therefore be correctly sized and maintained in place using supports. Electrical connection points on all types of devices (contactors, circuit breakers, etc.) should not be used for mechanical support.

Ties for flexible bars and cables

The table below indicates the maximum distance between ties depending on the prospective short-circuit current. The maximum distance between ties attached to the switchboard frame is 400 mm.

Type of tie	Maximum distance between ties (mm)	Short-circuit current (kA rms)
“PANDUIT” type ties	200	10
Width: 4.5 mm	100	14
Max. load: 22 kg	50	19
White		
“SAREL” type ties	350	21
Width: 9 mm	200	27
Max. load: 90 kg	100	36
Black	70	45
Double ties	50	100

Note: for 50 mm² cables, use the 9 mm wide ties.

Weights

Type	Circuit breaker	Plug-in base	Chassis	Motor mechanism
NSX100N/H DC	1P/1D	0.5	-	-
	2P/2D	1.45	-	-
NSX100 DC	3P/3D	1.79	0.8	2.2
	4P/4D	2.57	1.05	2.2
NSX160N/H DC	1P/1D	0.5	-	-
	2P/2D	1.45	-	-
NSX160N DC	3P/3D	1.85	0.8	2.2
	4P/4D	2.58	1.05	2.2
NSX250 DC	3P/3D	2.2	0.8	2.2
	4P/4D	2.78	1.05	2.2
NSX400/630 DC	3P/3D	6.19	2.4	2.2
	4P/4D	8.13	2.8	2.2
NSX1200 DC	2P/2D	8.9	-	2.8

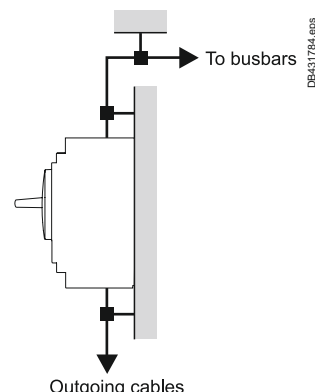

Compact NSX100 to NSX1200 DC

Power connections

B

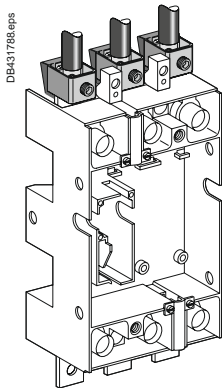
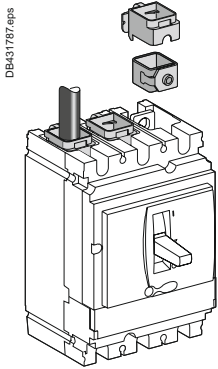
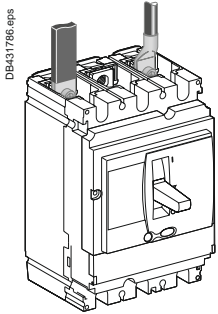

Connection of insulated bars or cables with lugs

	NSX100/160/250 DC	NSX400/630/1200 DC	
	Bars		
	L (mm)	≤ 25	≤ 32
	I (mm)	d + 10	d + 15
	d (mm)	≤ 10	≤ 15
	e (mm)	≤ 6	3 ≤ e ≤ 10
	Lugs		
	L (mm)	≤ 25	≤ 32
	Ø (mm)	8.5	10.5
	Tightening torque (Nm) ^[1]	15	50
	Tightening torque (Nm) ^[2]	5	20

[1] Tightening torque for lugs or bars on the circuit breaker.

[2] Tightening torque for rear connections or terminal extensions on plug-in base.

Connection of bare cables

NSX100 to 250 DC

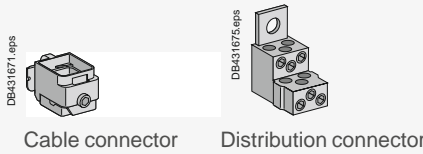

	Cable connector	Steel	Aluminium		
		≤ 160 A	≤ 250 A		
	L (mm)	20	20		
	S (mm ²) Cu/Al	1.5... 95 ^[1]	10... 16	25... 35	50... 185 150 max. flexible
	Tightening torque (Nm)	12	15	20	26
6-cable distribution connector (copper or aluminium)					
	L (mm)	15 or 30			
	S (mm ²) Cu/Al	1.5... 6 ^[1]	8... 35		
	Tightening torque (Nm)	4	6		

[1] For flexible cables from 1.5 to 4 mm², connection with crimped or self-crimping ferrule.

NSX400 to 630 DC

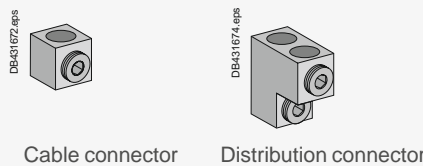

	Cable connector	2-cable connector	
	L (mm)	30 or 60	
	S (mm ²) Cu/Al	35 to 300 rigid 240 max. flexible	2 x 85 to 2 x 240 rigid 240 max. flexible
	Tightening torque (Nm)	31	31

NSX1200 DC

	2-cable connector	
	L (mm)	30 or 60
	S (mm ²) Cu/Al	2 x 85 to 2 x 240 rigid 240 max. flexible
	Tightening torque (Nm)	31

Compact NSX100 to NSX1200 DC

Safety clearances, minimum distances and insulation of live parts

When installing a Compact NSX100 to 1200 DC circuit breaker, minimum distances (safety clearances) must be maintained between the device and panels, bars and other protection devices installed nearby. These distances, which depend on the ultimate breaking capacity, are defined by tests carried out in accordance with standard IEC 60947-2.

If installation conformity is not checked by type tests, it is also necessary to:

- use insulated bars for circuit breaker connections
- block off the busbars using insulating screens.

Terminal shields, interphase barriers and the insulation kit are recommended and may be mandatory depending on the utilisation voltage and the type of installation (fixed, withdrawable).

Dimensions (mm)	Insulation, insulated bars or painted sheet metal			Sheetmetal						
	C1	D1	D2	C2	D1	D2	A1 [2]	A2 [3]	B	
Compact circuit breaker										
NSX100-250 DC	U ≤ 250 V	0	30	30	5	35	35	0	10	0
	U ≤ 500 V	0	30	30	10 [1]	35	35	0	20	0
	U ≤ 750 V	0	30 [4]	30 [4]	20 [4]	35 [4]	35 [4]	0	-	0
NSX400-630 DC	U ≤ 250 V	0	30	30	5	60	60	0	10	0
	U ≤ 500 V	0	30	30	10 [1]	60	60	0	20	0
	U ≤ 750 V	0	30 [4]	30 [4]	20 [4]	100 [4]	100 [4]	0	-	0
NSX1200 DC [5]	U ≤ 300 V	0	30	30	10	60	60	0	-	0
	U ≤ 600 V	0	30	30	20	100	100	0	-	0

[1] Distance must be doubled with interphase barriers.

[2] For Compact NSX DC with long or short terminal shields.

[3] For Compact NSX DC without terminal shields.

[4] For voltage > 500 V, terminal shields are mandatory. The length of terminal shields (long or short terminal shields) should be considered.

[5] For Compact NSX1200 DC, terminal shields are required and are supplied with the circuit breaker.

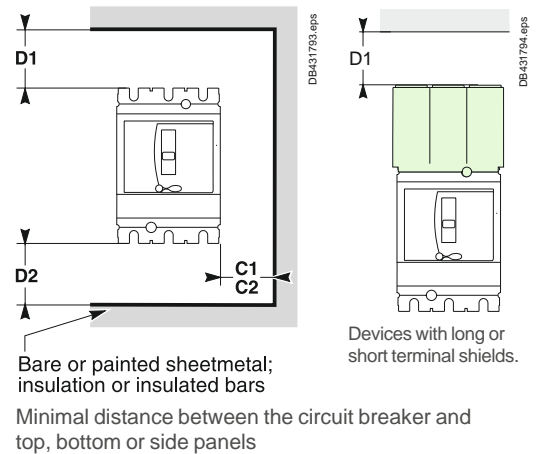
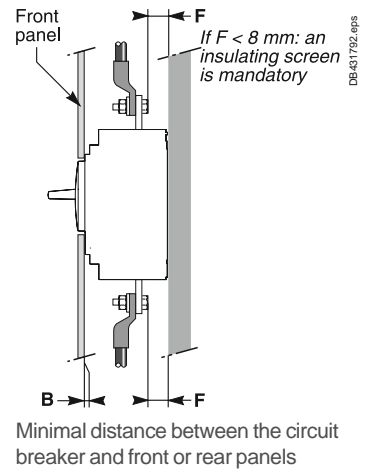
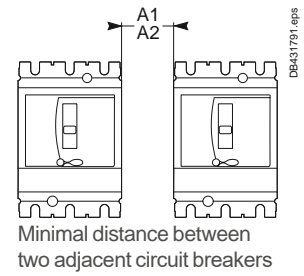

Terminal shield configuration

	NSX400/630/1200, NSX400/630 NA					NSX1200
Circuit breaker construction	3P	3P	4P	4P	4P	2P (4P platform)
Pole connection	3P in series	2P in series	3P in series	4P in series	2P parallel	-
Terminal shield construction	3P	3P	4P	4P	4P	4P
upstream	LV438291	LV432593	LV438294	LV432594	LV438293	LV438293
upstream with rear connection	LV438291	LV432593 or LV432591 (short)	LV438294	LV432594 or LV432592 (short)	-	-
downstream	LV438291	LV438292	LV438295	LV438293	LV438293	LV438293

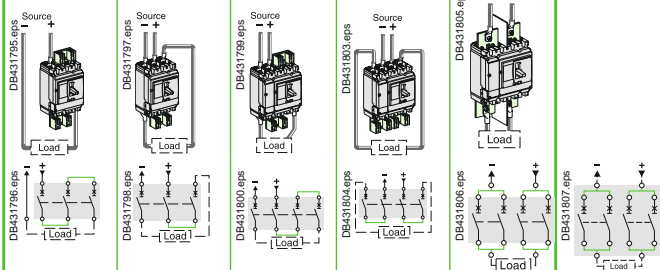

Compact NSX100 to NSX1200 DC

Temperature derating

These values are valid for fixed and withdrawable circuit breakers with or without terminal shields.

- "≤ 500 V" means that 2 poles only are used, for isolated system, this table shall be used up to 250 V only.
- "> 500 V" means that 3 or 4 poles are used, for isolated system, this table shall be used up to 500 V only.

When the ambient temperature is greater than 40 °C, overload-protection characteristics are slightly modified.

To determine tripping times using time/current curves, use the values of the current indicated in the table below, corrected to take into account the ambient temperature.

Compact NSX DC temperature derating

NSX DC configuration	Type of trip unit	Rating In (A) for a given temperature						
		Ambient temp. 40 °C	Ambient temp. 45 °C	Ambient temp. 50 °C	Ambient temp. 55 °C	Ambient temp. 60 °C	Ambient temp. 65 °C	Ambient temp. 70 °C
NSX100 DC 1/2P 1P 250 V - 2P 500 V	TM16D	16	15.6	15.2	14.8	14.5	14	13.8
	TM25D	25	24.5	24	23.5	23	22	21
	TM30D	30	31.3	30.5	30	29.5	29	28.5
	TM40D	40	39	38	37	36	35	34
	TM50D	50	49	48	47	46	45	44
	TM63D	63	61.5	60	58	57	55	54
	TM80D	80	78	76	74	72	70	68
TM100D	100	97.5	95	92.5	90	87.5	85	
NSX160 DC 1/2P 1P 250 V - 2P 500 V	TM125D	125	122	119	116	113	109	106
	TM160D	160	156	152	147	144	140	136
NSX100 DC 3/4P ≤ 500 V	TM16D	16.8	16.4	16	15.5	15.2	14.7	14.5
	TM25D	26.3	25.7	25.2	24.7	24.2	23.1	22.1
	TM32D	33.6	33	32	31.5	31	30.5	30
	TM40D	42	41	40	39	38	37	36
	TM50D	53	51	50	49	48	47	46
	TM63D	66	65	63	61	60	58	57
	TM80DC	84	82	80	78	76	74	71
TM100DC	105	102	100	97	95	92	89	
NSX160 DC 3/4P ≤ 500 V	TM125DC	131	128	125	122	119	114	111
	TM160DC	168	164	160	154	151	147	143
NSX250 DC 3/4P ≤ 500 V	TM200DC	210	205	200	194	189	184	179
	TM250DC	250	240	235	230	220	210	200
NSX100 DC 3/4P > 500 V	TM16D	16	15.6	15.2	14.8	14.5	14	13.8
	TM25D	25	24.5	24	23.5	23	22	21
	TM32D	32	31.3	30.5	30	29.5	29	28.5
	TM40D	40	39	38	37	36	35	34
	TM50D	50	49	48	47	46	45	44
	TM63D	63	61.5	60	58	57	55	54
	TM80DC	80	78	76	74	72	70	68
TM100DC	100	97.5	95	92.5	90	87.5	85	
NSX160 DC 3/4P > 500 V	TM125DC	125	122	119	116	113	109	106
	TM160DC	160	156	152	147	144	140	136
NSX250 DC > 500 V	TM200DC	200	195	190	185	180	175	170
	TM250DC	230	225	220	210	200	190	180
NSX400 DC ≤ 500 V	TM250DC	250 A	250 A	240 A	230 A	220 A	205 A	195 A
	TM320DC	320 A	320 A	315 A	305 A	295 A	280 A	270 A
	TM400DC	400 A	400 A	395 A	380 A	370 A	355 A	340 A
NSX400 DC > 500 V	TM250DC	250 A	250 A	240 A	230 A	220 A	205 A	195 A
	TM320DC	320 A	320 A	315 A	305 A	295 A	280 A	270 A
	TM400 DC	400 A	400 A	395 A	380 A	370 A	350 A	340 A
NSX630 DC ≤ 500 V	TM500DC	500 A	500 A	490 A	475 A	460 A	440 A	420 A
	TM600DC	600 A	600 A	585 A	560 A	535 A	510 A	485 A
NSX630 DC > 500 V	TM500DC	500 A	480 A	465 A	450 A	440 A	420 A	410 A
	TM600DC	-	-	-	-	-	-	-
NSX1200 DC 600 V	TM630DC	630 A	610 A	590 A	570 A	550 A	520 A	500 A
	TM800DC	800 A	775 A	740 A	720 A	695 A	665 A	640 A
	TM1000DC	1000 A	970 A	930 A	905 A	870 A	830 A	800 A
	TM1200DC	1200 A	1160 A	1115 A	1085 A	1040 A	995 A	955 A
NSX400 NA DC ≤ 500 V		400 A	400 A	400 A	400 A	400 A	400 A	400 A
NSX400 NA DC > 500 V		400 A	400 A	400 A	400 A	400 A	400 A	400 A
NSX600 NA DC ≤ 500 V		630 A	600 A	580 A	560 A	540 A	520 A	500 A
NSX600 NA DC > 500 V		605 A	585 A	570 A	550 A	530 A	505 A	485 A



Example: Compact NSX100 DC equipped with a TM80DC trip unit has a rating of:
 84 A at 40 °C
 78 A at 55 °C.

Compact NSX100 to NSX1200 DC

Characteristics of circuit breakers with parallel connection of poles

When poles are connected in parallel, the trip unit corresponding to the maximum circuit breaker rating is never used, for safety reasons related to temperature rise. The heating conditions are modified. The table opposite indicates the new thermal ratings that should be used for 2P, 3P and 4P circuit breakers.

Type of circuit breaker	Pole connections	Type of trip unit	Equivalent rated current ^[1] In (A) at 40 °C	Magnetic threshold Im (A) ±20 %	Breaking capacity Icu (kA)		
					250 V	500 V	
NSX100F DC					250 V	500 V	
NSX100F DC 2-pole See example 2 (see page A-8)	2P in parallel	TM16D	40	520	36	-	
		TM25D	63	800			
		TM30D	80	800			
		TM40D	100	1400			
		TM50D	125	1400			
		TM63D	158	1400			
		TM80D	200	1600			
NSX100F DC 3-pole	3P in parallel	TM16D	58	780	Please consult us	-	
		TM25D	90	1200			
		TM32D	115	1650			
		TM40D	144	2100			
		TM50D	180	2100			
		TM63D	227	2100			
		TM80DC	288	2400			
		TM16G	58	240			
		TM25G	90	300			
		TM40G	144	300			
		TM63G	227	450			
		TM80G	288	750			
		TM100G	360	1200			
NSX100F DC 4-pole	4P in parallel	TM16D	74	1040	Please consult us	-	
		TM25D	115	1600			
		TM32D	147	2200			
		TM40D	184	2800			
		TM50D	230	2800			
		TM63D	290	2800			
		TM80DC	368	3200			
		TM16G	74	320			
		TM25G	115	400			
		TM40G	184	400			
		TM63G	290	600			
		TM80G	368	1000			
		TM100G	460	1600			
	2 x 2P (in parallel) in series		TM16D	37	520	36	36
			TM25D	58	800		
			TM32D	74	1100		
			TM40D	46	1400		
			TM50D	115	1400		
			TM63D	145	1400		
			TM80DC	184	1600		
			TM16G	37	160		
			TM25G	58	200		
TM40G	46	200					
TM63G	145	300					
TM80G	184	500					
TM100G	230	800					

[1] Rated current of the assembly with the indicated pole connections.
 Example : a Compact NSX100F DC 4-pole circuit breaker with 4 poles in parallel, equipped with a TM63D trip unit:
 an equivalent rated current of 290 A
 a fixed magnetic threshold of 2800 A.



Compact NSX100 to NSX1200 DC

Characteristics of circuit breakers with parallel connection of poles

When poles are connected in parallel, the trip unit corresponding to the maximum circuit breaker rating is never used, for safety reasons related to temperature rise. The heating conditions are modified. The table opposite indicates the new thermal ratings that should be used for 2P, 3P and 4P circuit breakers.

B

Type of circuit breaker	Pole connections	Type of trip unit	Equivalent rated current ^[1] I _n (A) at 40 °C	Magnetic threshold I _m (A) ±20 %	Breaking capacity	
					I _{cu} (kA)	I _{cs} (kA)
NSX160F DC					250 V	500 V
NSX160F DC 2-pole	2P in parallel	TM125D	313	2400	36	-
NSX160F DC 3-pole	3P in parallel	TM100DC	360	2400	Please consult us	-
		TM125DC	450	3750		
		TM125G	450	1560		
		TM160G	576	1560		
NSX160F DC 4-pole	4P in parallel	TM100DC	460	3200		
		TM125DC	575	5000		
		TM125G	575	2080		
		TM160G	736	2080		
See example 1 (see page A-8)	2x2P (in parallel) in series	TM100DC	230	1600	36	36
		TM125DC	288	2500		
		TM125G	288	1040		
		TM160G	368	1040		
NSX250F DC						
NSX250F DC 3-pole	2P in parallel	TM160DC	400	2500	36	-
		TM200DC	500	2000 to 4000		
NSX250F DC 3-pole	3P in parallel	TM160DC	576	3750	Please consult us	-
		TM200DC	720	3000 to 6000		
		TM200G	720	1560		
		TM250G	900	1875		
NSX250F DC 4-pole	4P in parallel	TM160DC	736	5000		
		TM200DC	920	4000 to 8000		
		TM200G	920	2080		
		TM250G	1150	2500		
	2x2P (in parallel) in series	TM160DC	368	2500	36	36
		TM200DC	460	2000 to 4000		
		TM200G	460	1040		
		TM250G	575	1250		

Example : a Compact NSX160F DC 4-pole circuit breaker with 2x2P poles in parallel, equipped with a TM125DC trip unit:

- an equivalent rated current of 288 A
- a fixed magnetic threshold of 2500 A.

Compact NSX100 to NSX1200 DC

Characteristics of circuit breakers with parallel connection of poles

When poles are connected in parallel, the trip unit corresponding to the maximum circuit breaker rating is never used, for safety reasons related to temperature rise. The heating conditions are modified. The table opposite indicates the new thermal ratings that should be used for 2P, 3P and 4P circuit breakers.

Type of circuit breaker	Pole connections	Type of trip unit	Equivalent rated current ^[1] In (A) at 40 °C	Magnetic threshold Im (A) ±20 %	Breaking capacity Icu (kA)	
					250 V	500 V
NSX400F DC						
NSX400F DC 3-pole	2P in parallel	TM250DC	500	1250 to 2000	36	-
		TM320DC	640	1600 to 3200		
	3P in parallel	TM250DC	750	1875 to 3000		
TM320DC		960	2400 to 4800			
NSX400F DC 4-pole	4P in parallel	TM250DC	1000	2500 to 4000	36	36
		TM320DC	1280	3200 to 6400		
	2x2P (in parallel) in series	TM250DC	500	1250 to 2000		
		TM320DC	640	1600 to 3200		
NSX630F DC						
NSX630F DC 3-pole	2P in parallel	TM500DC	1000	2500 to 5000	36	-
		TM600DC	1065	3000 to 6000		
NSX630F DC 3-pole	3P in parallel	TM500DC	1485	3750 to 7500	36	-
		TM600DC	1500	4500 to 9000		
NSX630F DC 4-pole	4P in parallel	TM500DC	1650	5000 to 10000	36	-
		TM600DC	1985	6000 to 12000		

B

Compact NSX DC PV

Safety clearances and minimum distances

B

Safety clearance using terminals shields

- Terminal shields must be used with all DC PV circuit breakers when operating at 1000 V DC.
- Terminal shields can be used in option with DC PV switch-disconnectors ($U \leq 1000$ V DC).

Minimal distance between two adjacent devices

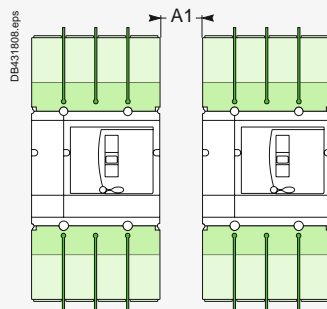

Minimal distance between the device and panels

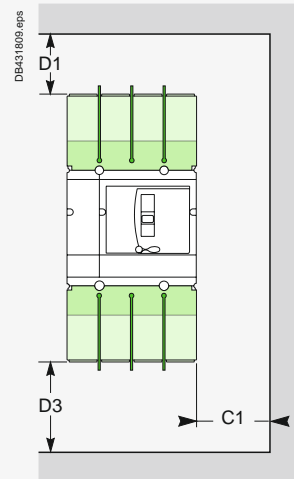

Dimensions (mm)	Insulation, insulated bars or painted sheet metal			
	C1	D1	D3	A1
NSX80-500 TM DC PV	30	30	30	30
NSX100-500 NA DC PV	30	30	30	30
NSX630b-1600 NA DC PV	30	30	30	30

Minimal distance between the device and panels

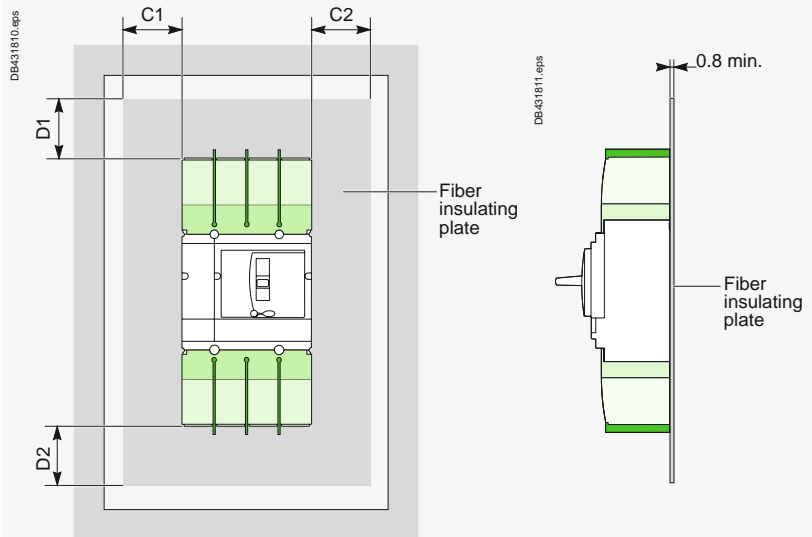

Dimensions (mm)	C1	C2	D1	D2
NSX80 to 200 DC PV	13	13	13	13
NSX250 to 500 DC PV	25.4	25.4	25.4	25.4

Note: the thermal behaviour of switchgear and enclosures warrants careful monitoring. PV generator boxes and array boxes are usually installed outdoors and exposed to the elements. In the event of high ambient temperatures, high IP levels could reduce air flow and thermal power dissipation. In addition, the way switchgear devices achieve high voltage operation - i.e. through the use of poles in series - increases their temperature. Special attention should therefore be paid to the temperature of switchgear inside outdoor enclosures on the DC side. Schneider Electric recommend to check the installation as per IEC 61439 or any other equivalent standard.

Installation recommendations

Compact NSX DC PV

Safety clearances and minimum distances

Safety clearance with interphase barriers

■ Interphase barriers can be used **only with DC PV switch-disconnectors** ($U \leq 1000$ V DC).

Minimal distance between two adjacent devices

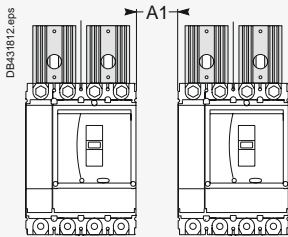

Minimal distance between the device and panels

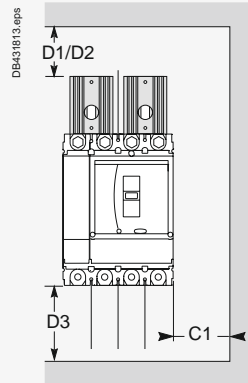

Rear panel: insulation screen mandatory

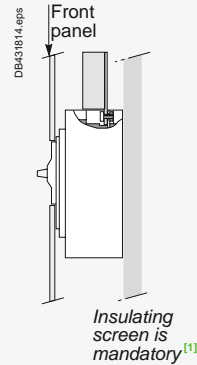

[1] Dimensions of the insulating screen are identical as for the circuit breaker (see page B-10).

Dimensions (mm)	Insulation, painted sheet metal			Sheetmetal			
	C1	D1	D3	C1	D2	D3	A1
NSX100-200 NA DC PV	50	50	100	50	100	100	50
NSX400-500 NA DC PV	70	70	100	70	100	100	70
NSX630b-1600 NA DC PV	70	70	125	70	100	125	70

Note: the thermal behaviour of switchgear and enclosures warrants careful monitoring. PV generator boxes and array boxes are usually installed outdoors and exposed to the elements. In the event of high ambient temperatures, high IP levels could reduce air flow and thermal power dissipation.

In addition, the way switchgear devices achieve high voltage operation - i.e. through the use of poles in series - increases their temperature. Special attention should therefore be paid to the temperature of switchgear inside outdoor enclosures on the DC side.

Schneider Electric recommend to check the installation as per IEC 61439 or any other equivalent standard.



Compact NSX200 NA DC PV with short heatsinks and interphase barriers.



Compact NSX200 NA DC PV with long heatsinks and interphase barriers.

B

Compact NSX DC PV

Temperature derating

Compact switch-disconnectors have been tested for operation in industrial atmospheres. It is recommended that the equipment be cooled or heated to the proper operating temperature and kept free of excessive vibration and dust.

B

DC PV switch-disconnectors													
Compact NSX NA DC PV													
IP	Bottom interphase barrier	Bottom terminal shield	Top interphase barrier	Top terminal shield	Top series connection	Maximum current (A): I _{th}							Cooper cable section ⁽¹⁾
						40 °C	45 °C	50 °C	55 °C	60 °C	65 °C	70 °C	
NSX100 NA DC PV 4P													
IP0	3 (LV429329)	No	1 (LV429329)	No	Short 2 x LV438328	100	100	100	100	100	100	100	Cu 35 mm ²
IP4X	No	LV429518	No	LV438327	Short 2 x LV438328	100	100	100	100	100	100	100	Cu 35 mm ²
NSX160 NA DC PV 4P													
IP0	3 (LV429329)	No	1 (LV429329)	No	Short 2 x LV438328	160	160	160	160	160	155	145	Cu 70 mm ²
IP0	3 (LV429329)	No	1 (LV429329)	No	Long 2 x LV438339	160	160	160	160	160	160	160	Cu 70 mm ²
IP4X	No	LV429518	No	LV438327	Short 2 x LV438328	160	160	160	160	150	145	135	Cu 70 mm ²
NSX200 NA DC PV 4P													
IP0	3 (LV429329)	No	1 (LV429329)	No	Short 2 x LV438328	200	195	190	180	170	160	150	Cu 95 mm ²
IP0	3 (LV429329)	No	1 (LV429329)	No	Long 2 x LV438339	200	200	200	200	195	185	170	Cu 95 mm ²
IP4X	No	LV429518	No	LV438327	Short 2 x LV438328	190	180	175	165	155	150	140	Cu 95 mm ²
NSX400 NA DC PV 4P													
IP3X	No	LV432594	No	LV438337	LV438338	400	400	400	400	400	390	380	Cu 240 mm ²
IP0	3 (LV432570)	No	1 (LV429329)	No	LV438338	400	400	400	400	400	400	400	Cu 240 mm ²
NSX500 NA DC PV 4P													
IP3X	No	LV432594	No	LV438337	LV438338	500	500	490	470	450	435	420	Cu 2 x 150 mm ²
IP0	3 (LV432570)	No	1 (LV429329)	No	LV438338	500	500	500	500	500	500	480	Cu 2 x 150 mm ²

For Compact NSX the overload protection is calibrated at 40 °C and for C60 DC PV at 20 °C. This means that when the ambient temperature is less or greater than these temperatures, the Ir protection pickup is slightly modified.

- Temperature rise for Compact range have been checked with terminal shields (mandatory) heatsink on top, four cables on bottom connections with section and length according to IEC60947-1 Table 9 and 10.
- Values in the tables are provided for vertical mounting only. In case of horizontal mounting consult us. To obtain the tripping time for a given temperature:
 - see the tripping curves for 20 or 40 °C
 - determine tripping times corresponding to the Ir value (thermal setting on the device), corrected for the breaker ambient temperature as indicated in the tables below.

DC PV overcurrent protection												
Compact NSX TM DC PV												
Maximum current (A): I _{th}											Cooper cable section ^[1]	
	20 °C	25 °C	30 °C	35 °C	40 °C	45 °C	50 °C	55 °C	60 °C	65 °C		70 °C
NSX80 TM DC PV												
88	86	84	82	80	77	75	72	69	66	63		Cu 25 mm ²
NSX125 TM DC PV												
137.5	135	131	128	125	121	116	112	108	103	98		Cu 50 mm ²
NSX160 TM DC PV												
176	172	168	164	160	153	147	142	136	130	124		Cu 70 mm ²
NSX200 TM DC PV												
194	189	183	178	172	167	161	155	149	142	136		Cu 95 mm ²
200	200	200	200	200	188	182	175	168	160	153		Cu 95 mm ² ^[2]
NSX250 TM DC PV												
302	295	288	280	250	243	235	228	220	210	197		Cu 120 mm ²
NSX320 TM DC PV												
371	362	352	342	320	309	297	286	273	261	248		Cu 185 mm ²
NSX400 TM DC PV												
455	444	433	421	400	386	372	358	343	327	311		Cu 240 mm ²
NSX500 TM DC PV												
557	542	526	511	495	478	461	444	426	405	384		Cu 2x150 mm ²

[1] Temperature rise have been checked with four cables on bottom connections with section and length according to IEC60947-1 Table 9.

a. When used in array boxes, with short connection to string protections the cross section of the bars or cables shall have a higher cross section.

b. When cables have a cross section lower than the value indicated an additional 0.9 derating coefficient shall be applied. Values in the tables are provided for vertical mounting only.

[2] Take into account this derating line for products with date code over --15011.

Compact NSX DC PV Temperature derating - Power dissipation / Resistance

Compact NSX630b to 1600 DC PV switch-disconnectors [1]

All the given values comes from connections tests.

For other kind of connections (rear horizontal/rear vertical) the values remain the same.

DC PV switch-disconnector													
Compact NSX NA DC PV													
IP	Bottom interphase barrier	Bottom terminal shield	Top interphase barrier	Top terminal shield	Top series connection	Maximum current (A): I _m							Copper cable section
						40 °C	45 °C	50 °C	55 °C	60 °C	65 °C	70 °C	
NSX630b NA DC PV 4P													
IP2X	No	33629	No	LV438968	2 x LV438966	630	630	630	630	630	630	630	Cu 2 x 185 mm ²
IP0	3 (33646)	No	1 (33646)	No	2 x LV438966	630	630	630	630	630	630	630	Cu 2 x 185 mm ²
NSX800 NA DC PV 4P													
IP2X	No	33629	No	LV438968	2 x LV438966	800	800	800	800	800	800	800	Cu 2 x 240 mm ²
IP0	3 (33646)	No	1 (33646)	No	2 x LV438966	800	800	800	800	800	800	800	Cu 2 x 240 mm ²
NSX1000 NA DC PV 4P													
IP2X	No	33629	No	LV438968	2 x LV438966	1000	1000	1000	1000	1000	1000	1000	Bar Cu 2 x 60 x 5 mm
IP0	3 (33646)	No	1 (33646)	No	2 x LV438966	1000	1000	1000	1000	1000	1000	1000	Bar Cu 2 x 60 x 5 mm
NSX1250 NA DC PV 4P													
IP2X	No	33629	No	LV438968	2 x LV438966	1250	1250	1250	1250	1232	1169	1102	Bar Cu 2 x 80 x 5 mm
IP0	3 (33646)	No	1 (33646)	No	2 x LV438966	1250	1250	1250	1250	1250	1227	1157	Bar Cu 2 x 80 x 5 mm
NSX1600 NA DC PV 4P													
IP2X	No	33629	No	LV438968	2 x LV438966	1473	1428	1384	1338	1291	1243	1193	Bar Cu 2 x 100 x 5 mm
IP0	3 (33646)	No	1 (33646)	No	2 x LV438966	1500	1500	1500	1448	1397	1345	1291	Bar Cu 2 x 100 x 5 mm

[1] For a switch-disconnector mounted in horizontal position, the derating to be applied is equivalent to that of a front or horizontal rear connected switch-disconnector.

The values indicated in the tables opposite are typical values.

Power dissipated per pole (P/pole) in Watts (W)

The value indicated in the table is the power dissipated at I_N, four-pole switchboard (these values can be higher than the power calculated on the basis of the pole resistance). Measurement and calculation of the dissipated power are carried out in compliance with the recommendations of Annex G of standard IEC 60947-2.

Resistance per pole (R/pole) in milliohms (mΩ)

The value of the resistance per pole is provided as a general indication for a new device.

The value of the contact resistance must be determined on the basis of the measured voltage drop, in accordance with the manufacturer's test procedure.

Compact NSX80 TM to 500 TM DC PV switch-disconnectors		
Version	Fixed device TM	
	R/pole	P/pole
NSX80 TM DC PV	1	6.40
NSX100 TM DC PV	0.72	7.20
NSX125 TM DC PV	0.68	10.63
NSX160 TM DC PV	0.49	12.54
NSX200 TM DC PV	0.44	17.60
NSX250 TM DC PV	0.33	20.63
NSX320 TM DC PV	0.215	22.02
NSX400 TM DC PV	0.16	25.60
NSX500 TM DC PV	0.134	33.50

Compact NSX630b NA to 1600 NA DC PV switch-disconnectors		
Version	Fixed device NA	
	R/pole	P/pole
NSX630b NA DC PV	0.029	11.4
NSX800 NA DC PV	0.029	18.7
NSX1000 NA DC PV	0.030	29.7
NSX1250 NA DC PV	0.030	47.3
NSX1600 NA DC PV	0.033	74.0

Note: this measurement is not sufficient to determine the quality of the contacts, i.e. the capacity of the circuit breaker to carry its rated current.



Masterpact NW10 to NW40 DC - DC PV

Installation in switchboard

B

Possible positions

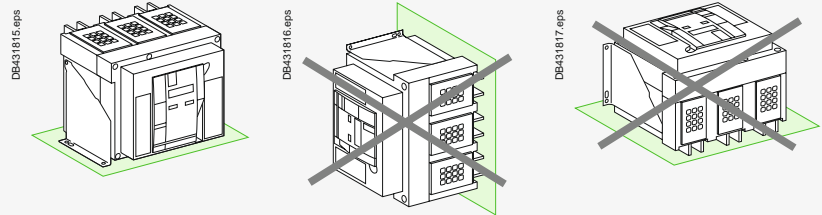

Power supply

The plus and minus polarities (**LINE + and LINE -**) of the power supply must be connected as indicated in the “Dimensions and connection” chapter.

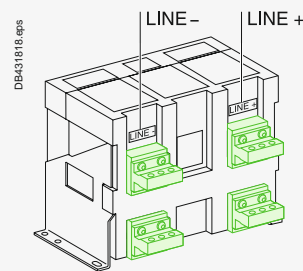

Mounting the circuit breaker

It is important to distribute the weight of the device uniformly over a rigid mounting surface such as rails or a base plate. This mounting plane should be perfectly flat (tolerance on support flatness: 2 mm). This eliminates any risk of deformation which could interfere with correct operation of the circuit breaker. Masterpact devices can also be mounted on a vertical plane using the special brackets.

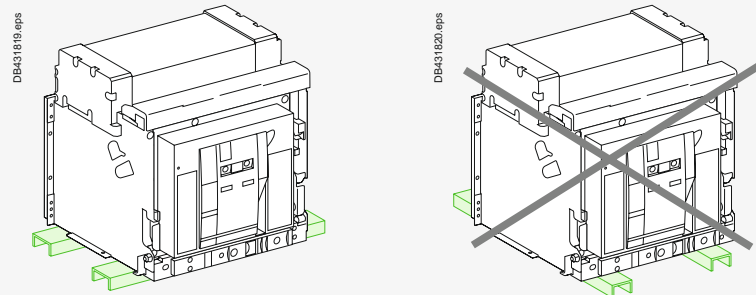

Mounting on rails.

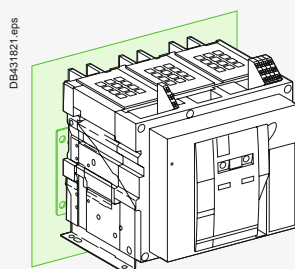

Mounting with vertical brackets.

Masterpact NW10 to NW40 DC - DC PV Door interlock

Mounted on the right or left-hand side of the cradle, this device inhibits opening of the cubicle door when the circuit breaker is in "connected" or "test" position.
If the breaker is put in the "connected" position with the door open, the door may be closed without having to disconnect the circuit breaker.

Door interlock catch VPEC

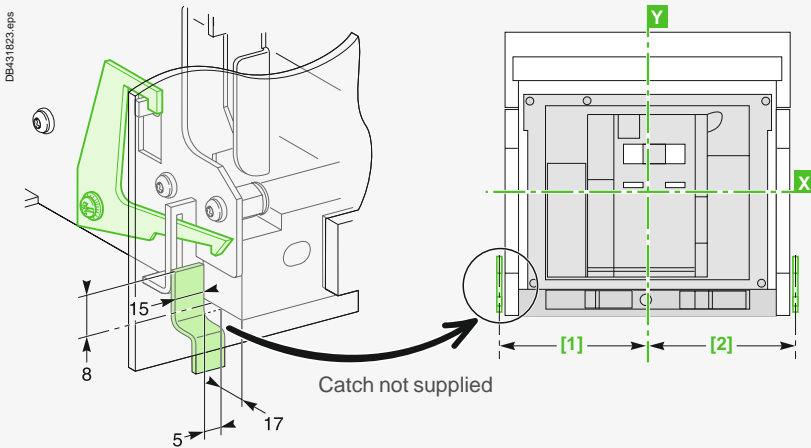

Dimensions (mm)

Type DC	[1]	[2]
NW10-40 DC (versions C-D)	215	215
NW10-40 DC (version E)	330	215
Type DC PV	[1]	[2]
NW10-40 DC PV (version D)	215	215

Breaker in "connected" or "test" position

Door cannot be opened

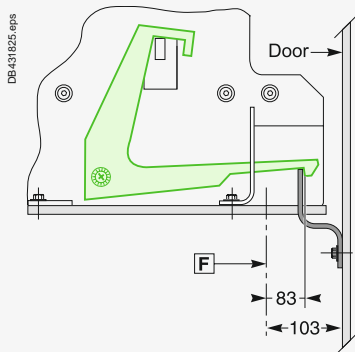

Breaker in "disconnected" position

Door can be opened

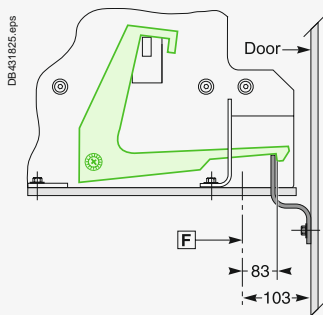

Note: The door interlock can either be mounted on the right side or the left side of the breaker.

F: Datum.

B

Masterpact NW10 to NW40 DC - DC PV

Cable-type door interlock - Connection of MN, MX and XF voltage releases

Cable-type door interlock IPA

This option prevents door opening when the circuit breaker is closed and prevents circuit breaker closing when the door is open.

For this, a special plate associated with a lock and a cable is mounted on the right side of the circuit breaker. With this interlock installed, the source changeover function cannot be implemented.

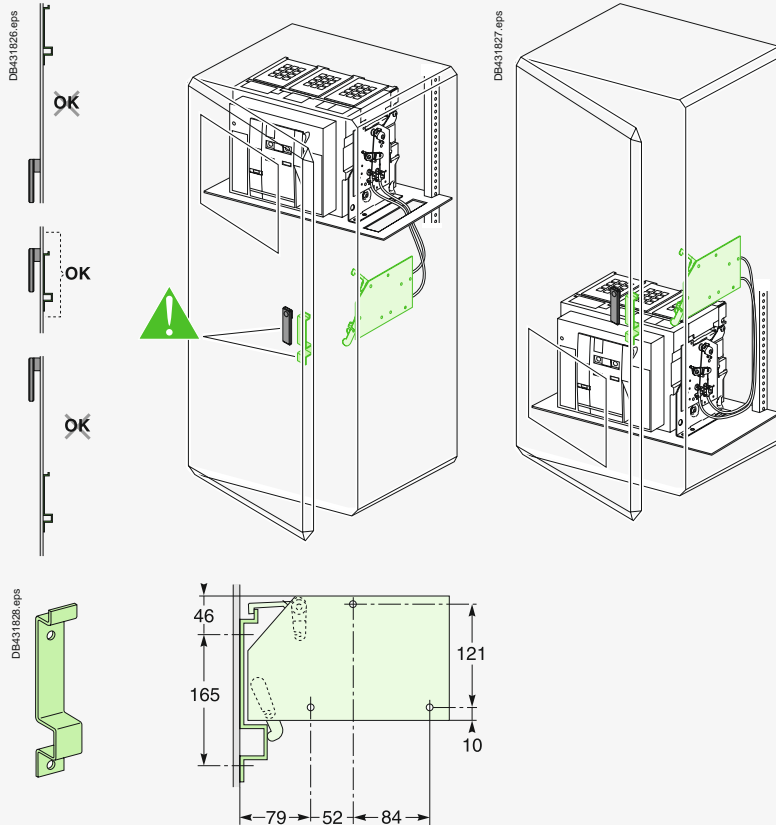

Wiring of voltage releases

During pick-up, the power consumed is approximately 150 to 200 VA. For low control voltages (12, 24, 48 V), maximum cable lengths are imposed by the voltage and the cross-sectional area of cables.

Recommended maximum cable lengths (meter)

		12 V		24 V		48 V	
		2.5 mm ²	1.5 mm ²	2.5 mm ²	1.5 mm ²	2.5 mm ²	1.5 mm ²
MN	U source 100 %	-	-	58	35	280	165
	U source 85 %	-	-	16	10	75	45
MX-XF	U source 100 %	21	12	115	70	550	330
	U source 85 %	10	6	75	44	350	210

Note: the indicated length is that of each of the two wires.

B

Masterpact NW10 to NW40 DC - DC PV Power connection

Cable connections

If cables are used for the power connections, make sure that they do not apply excessive mechanical forces to the circuit breaker terminals.

For this, make the connections as follows:

- extend the circuit breaker terminals using short bars designed and installed according to the recommendations for bar-type power connections:
- for a single cable, use solution **B** opposite
- for multiple cables, use solution **C** opposite.
- in all cases, follow the general rules for connections to busbars:
- position the cable lugs before inserting the bolts
- the cables should firmly secured to the framework of the switchboard **E**.

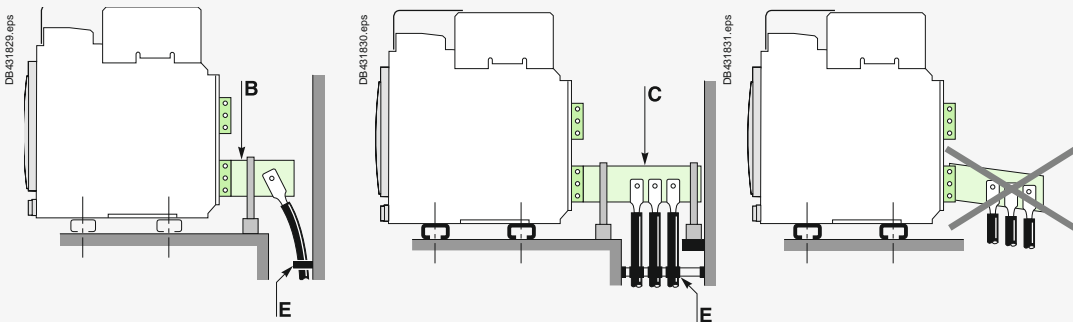

Busbar connections

The busbars should be suitably adjusted to ensure that the connection points are positioned on the terminals before the bolts are inserted **B**. The connections are held by the support which is solidly fixed to the framework of the switchboard, such that the circuit breaker terminals do not have to support its weight **C**. (This support should be placed close to the terminals).

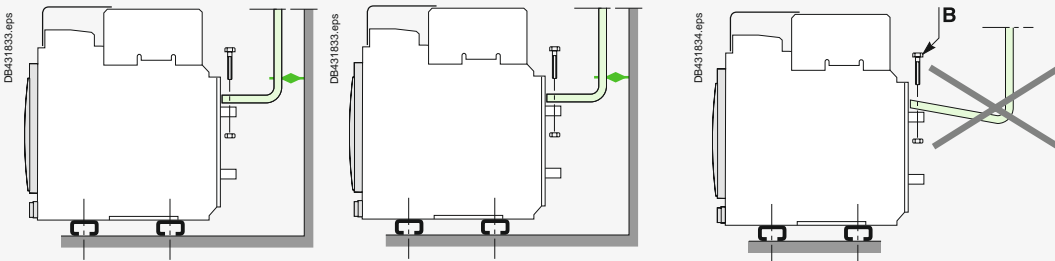

Electrodynamic stresses

The first busbar support or spacer shall be situated within a maximum distance from the connection point of the breaker (see table below). This distance must be respected so that the connection can withstand the electrodynamic stresses between phases in the event of a short circuit.

Maximum distance A between busbar to circuit breaker connection and the first busbar support or spacer with respect to the value of the prospective short-circuit current.					
Isc (kA)	30	50	65	80	100
distance A (mm)	350	300	250	150	150

B

Masterpact NW10 to NW40 DC - DC PV

Power connection

B

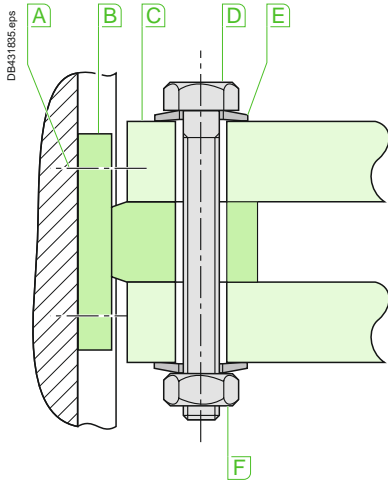

- A** Terminal screw factory-tightened to 16 Nm.
- B** Breaker terminal.
- C** Busbar.
- D** Bolt.
- E** Washer.
- F** Nut.

Clamping

Correct clamping of busbars depends amongst other things, on the tightening torques used for the nuts and bolts. Over-tightening may have the same consequences as under-tightening. For connecting busbars (Cu ETP-NFA51-100) to the circuit breaker, the tightening torques to be used are shown in the table below. These values are for use with copper busbars and steel nuts and bolts, class 8.8. The same torques can be used with AGS-T52 quality aluminium bars (French standard NFA 02-104 or American National Standard H-35-1).

Examples

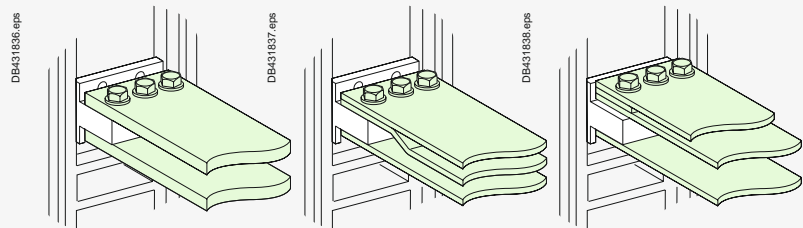

Tightening torques

Ø Nominal (mm)	Ø Drilling (mm)	Tightening torque (Nm) with flat washers or split lockwashers	Tightening torque (Nm) with contact or serrated washers
10	11	37.5	50

Busbar drilling

Examples

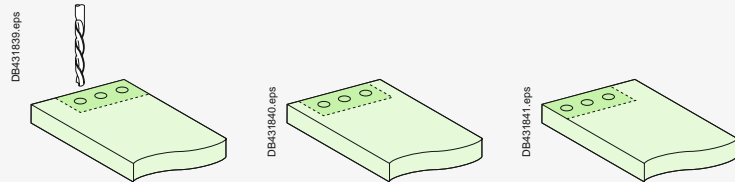

Isolation distance

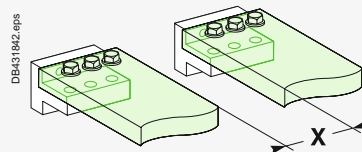

Dimensions (mm)

Ui	X mini
500 V DC	8 mm
900 V DC	14 mm

Busbar bending

When bending busbars maintain the radius indicated below (a smaller radius would cause cracks).

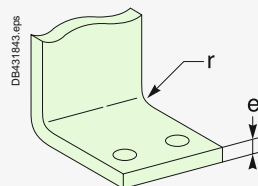

Dimensions (mm)

e	Radius of curvature r	
	Min.	Recommended
5	5	7.5
10	15	18 to 20

Masterpact NW10 to NW40 DC - DC PV Power connection

Horizontal rear connection NW10 to NW20 DC - DC PV

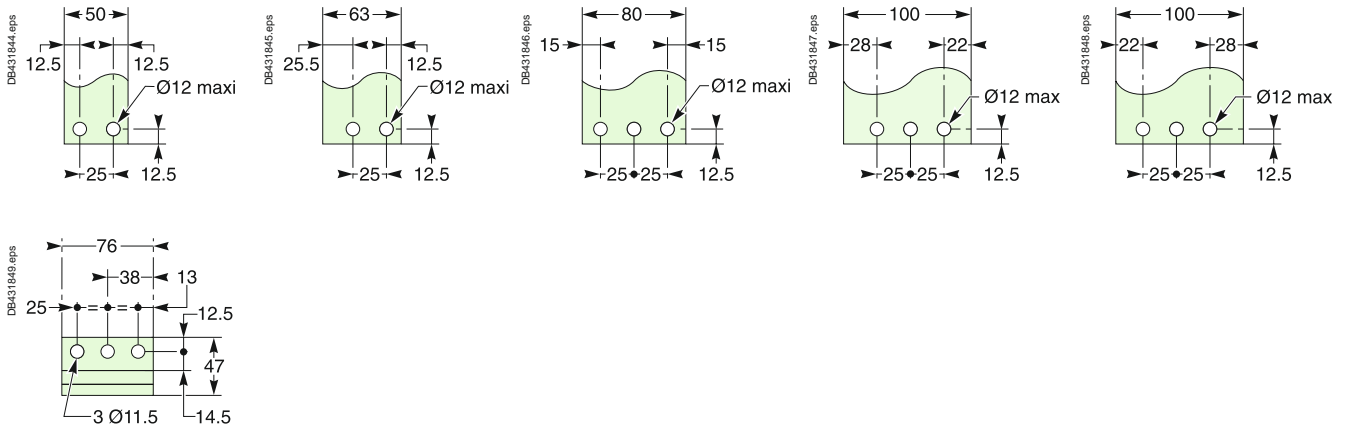

Vertical rear connection NW10 to NW20 DC - DC PV

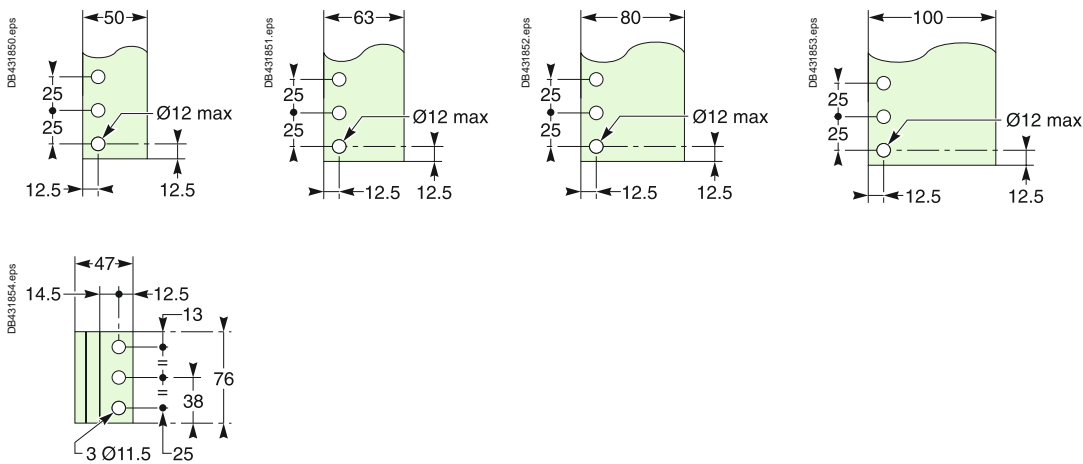

Vertical rear connection NW40 DC - DC PV

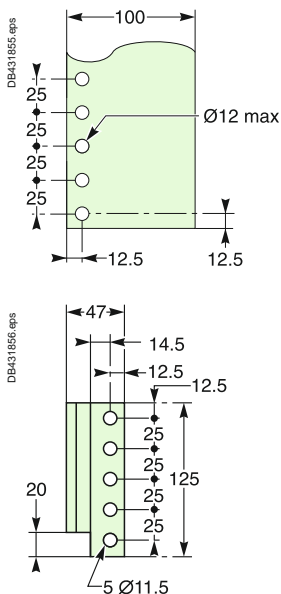

B

Masterpact NW10 to NW40 DC - DC PV Busbar sizing

B

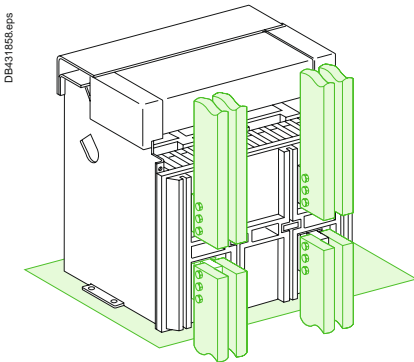
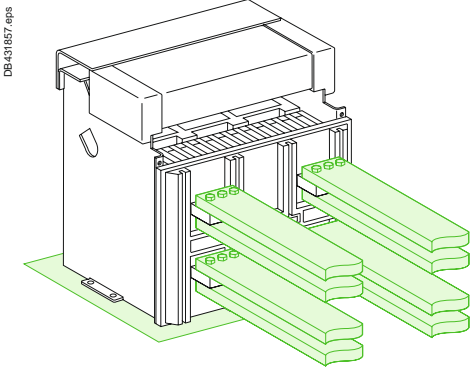

Rear horizontal connection

Basis of tables

- maximum permissible busbar temperature: 100 °C
- Ti: temperature around the circuit breaker and its connections
- busbar material is unpainted copper.

Example

Conditions:

- drawout version
- horizontal busbars
- Ti: 50 °C
- service current: 2000 A.

Solution

For Ti = 50 °C, use an NW20 DC - DC PV which can be connected with three 100 x 5 mm bars or two 80 x 10 mm bars.

Masterpact NW DC - DC PV	Maximum service current	Ti: 40 °C no. of bars		Ti: 50 °C no. of bars		Ti: 60 °C no. of bars	
		5 mm thick bars	10 mm thick bars	5 mm thick bars	10 mm thick bars	5 mm thick bars	10 mm thick bars
NW10 DC	1000	3b.50 x 5	1b.63 x 10	3b.50 x 5	2b.50 x 10	3b.63 x 5	2b.50 x 10
NW20 DC	2000	3b.100 x 5	2b.80 x 10	3b.100 x 5	2b.80 x 10	3b.100 x 5	3b.80 x 10
NW20 HADCD-PV	2000	3b.100 x 5	2b.80 x 10	3b.100 x 5	2b.80 x 10	3b.100 x 5	3b.80 x 10

Note: the values indicated in these tables have been extrapolated from test data and theoretical calculations. These tables are only intended as a guide and cannot replace industrial experience or a temperature rise test.

Rear vertical connection

Basis of tables

- maximum permissible busbar temperature: 100 °C
- Ti: temperature around the circuit breaker and its connections
- busbar material is unpainted copper.

Example

Conditions:

- fixed version
- vertical busbars
- Ti: 40 °C
- service current: 1000 A.

Solution

For Ti = 40 °C, use an NW10 DC - DC PV which can be connected with two 50 x 5 mm bars or one 50 x 10 mm bar.

Masterpact NW DC - DC PV	Maximum service current	Ti: 40 °C no. of bars		Ti: 50 °C no. of bars		Ti: 60 °C no. of bars	
		5 mm thick bars	10 mm thick bars	5 mm thick bars	10 mm thick bars	5 mm thick bars	10 mm thick bars
NW10 DC	1000	2b.50 x 5	1b.50 x 10	2b.50 x 5	1b.50 x 10	2b.63 x 5	1b.63 x 10
NW20 DC	2000	3b.100 x 5	2b.63 x 10	3b.100 x 5	2b.63 x 10	3b.100 x 5	3b.63 x 10
NW40 DC	4000	-	4b.100 x 10	-	4b.100 x 10	-	4b.100 x 10
NW20 HADCD-PV	2000	3b.100 x 5	2b.63 x 10	3b.100 x 5	2b.63 x 10	3b.100 x 5	3b.63 x 10
NW40 HADCD-PV	4000	-	4b.100 x 10	-	4b.100 x 10	-	4b.100 x 10

Note: the values indicated in these tables have been extrapolated from test data and theoretical calculations. These tables are only intended as a guide and cannot replace industrial experience or a temperature rise test.

Masterpact NW10 to NW40 DC - DC PV

Temperature derating - Power dissipation and input/output resistance

Temperature derating

The table below indicates the maximum current rating, for each connection type, as a function of the ambient temperature around the circuit breaker and the busbars. For ambient temperatures greater than 60 °C, consult us.

Ti: temperature around the circuit breaker and its connections.

Version	Drawout device										Fixed device															
	Rear horizontal					Rear vertical					Rear horizontal					Rear vertical										
temp. Ti	40	45	50	55	60	40	45	50	55	60	40	45	50	55	60	40	45	50	55	60						
NW DC																										
NW10	Version C	1000					1000					1000					1000									
	Version D	1000					1000					1000					1000									
	Version E	1000					1000					1000					1000									
NW20	Version C	2000					2000					2000					2000									
	Version D	2000					2000					2000					2000									
	Version E	2000					2000					2000					2000									
NW40	Version C	-					4000					-					4000									
	Version D	-					4000					3900 3750 3600					-					4000				
	Version E	-					4000					3800 3650 3500					-					4000				
NW DC PV																										
NW20	Version D	2000					2000					2000					2000									
NW40	Version D	-					4000					3900 3750 3600					-					4000				

Power dissipation and input/output resistance

Total power dissipation is the value measured at IN, for a 3 pole (version C, D [1]) or 4 pole (version E) breaker (values above the power P = 3RI²).

[1] DC PV version D only.

Version	Drawout device			Fixed device		
	Power dissipation (Watt)			Power dissipation (Watt)		
Version	C	D	E	C	D	E
NW10 DC	45	75	105	25	40	60
NW20 DC	135	230	330	90	160	235
NW40 DC	460	800	1150	360	580	850

Version	Drawout device	Fixed device
	Power dissipation (Watt)	Power dissipation (Watt)
Version	D	D
NW20 HADCD-PV	230	160
NW40 HADCD-PV	800	580





Dimensions and connection

Compact (fixed version) 1P-2P NSX100-NSX160 DC	
Dimensions, mounting, cutout.....	C-2
Dimensions and mounting	
Compact NSX100 to 1200 DC fixed version.....	C-4
Compact NSX100 to 630 DC plug-in version.....	C-6
Compact NSX100 to 630 DC withdrawable version.....	C-8
Motor mechanism module for Compact NSX100 to 1200 DC.....	C-10
Direct rotary handle for Compact NSX100 to 1200 DC.....	C-11
MCC and CNOMO type direct rotary handles for Compact NSX100 to 1200 DC fixed version.....	C-12
Extended rotary handle for Compact NSX100 to 1200 DC.....	C-13
Front-panel accessories	
Compact NSX100 to 1200 DC.....	C-14
Power connections	
Compact NSX100 to 1200 DC fixed version.....	C-16
Compact NSX100 to 630 DC fixed version.....	C-18
Connection of insulated bars or cables with lugs to Compact NSX100 to 1200 DC.....	C-20
Connection of bare cables to Compact NSX100 to 1200 DC.....	C-21
Compact (fixed version) 2P-3P-4P Parallel and series connection of poles	
Compact NSX100 to NSX250 DC.....	C-22
Compact NSX400 to NSX630 DC.....	C-23
Compact (fixed version) 4P Parallel and series connection of poles	
Compact NSX630 to NSX1200 DC.....	C-24
Compact (withdraw. version) 3P-4P Parallel and series connection of poles	
Compact NSX100 to NSX250 DC.....	C-25
Compact NSX400 to NSX630 DC.....	C-26
Compact (fixed version) 4P connection of poles, dimensions and mounting	
Compact NSX100 to NSX630 DC PV.....	C-27
Compact (fixed version) 4P connection of poles, dimensions	
Compact NSX630b to 1600 DC PV.....	C-28
Compact (fixed version) 4P front connection of poles, mounting	
Compact NSX630b to 1600 DC PV.....	C-29
Compact (fixed version) 4P rear connection of poles, mounting	
Compact NSX630b to 1600 DC PV.....	C-30
Masterpact (fixed device)	
NW10 to 40 DC version C/D (3P), version E (4P) NW10 to 40 DC PV version D (3P).....	C-31
NW10 to 40 DC-Version C.....	C-32
NW10 to 40 DC-DC PV-Version D.....	C-33
NW10 to 40 DC-Version E.....	C-34
Masterpact (drawout device)	
NW10 to 40 DC version C/D (3P) version E (4P) NW10 to 40 DC PV version D (3P).....	C-35
NW10 to 40 DC-Version C.....	C-36
NW10 to 40 DC-DC PV-Version D.....	C-37
NW10 to 40 DC-Version E.....	C-38
Masterpact NW10 to 40 DC-DC PV	
Accessories.....	C-39
Dimensions and mounting	
External modules for Compact and Masterpact.....	C-41
FDM121 switchboard display.....	C-42
FDM128 switchboard display.....	C-43

Other chapters

Presentation.....	2
Functions and characteristics.....	A-1
Installation recommendations.....	B-1
Electrical diagrams.....	D-1
Additional characteristics.....	E-1
Catalogue numbers and order form.....	F-1

Compact (fixed version) 1P-2P NSX100-NSX160 DC

Dimensions, mounting, cutout

Dimensions

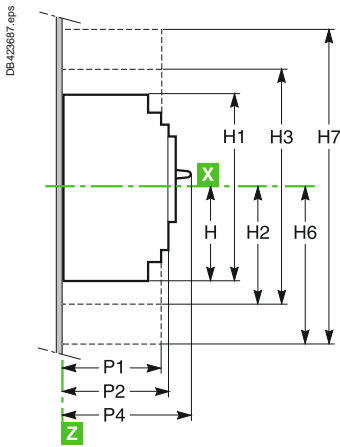

1 pole

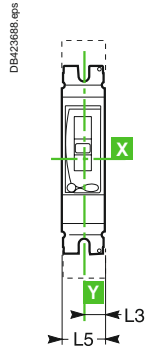

2 poles

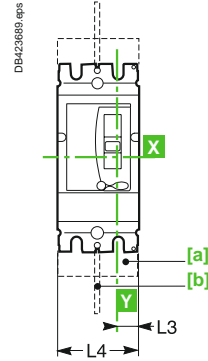

[a] Short terminal shields.
[b] Interphase barriers.

Mounting

On backplate

1 pole

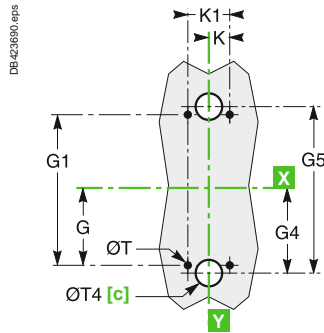

[c] For rear connection only.

2 poles

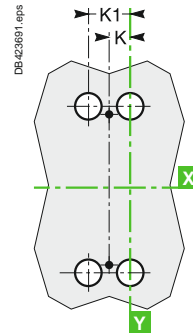

On rails

1 pole

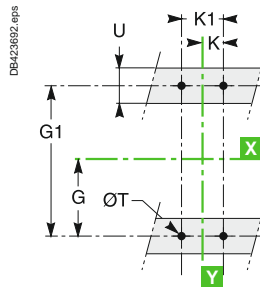

2 poles

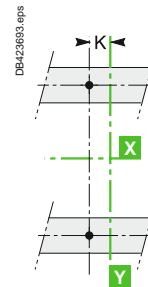

Compact (fixed version) 1P-2P NSX100-NSX160 DC

Dimensions, mounting, cutout

Front-panel cutout

On backplate

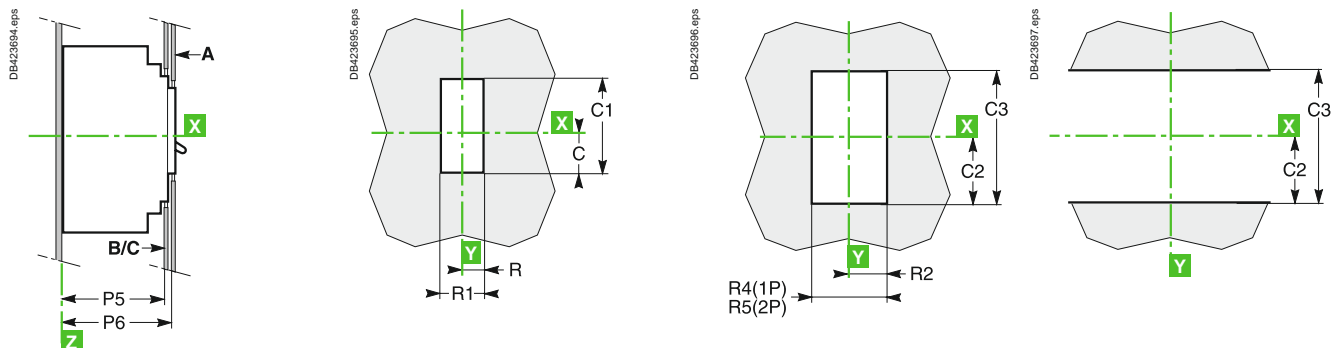

With escutcheon

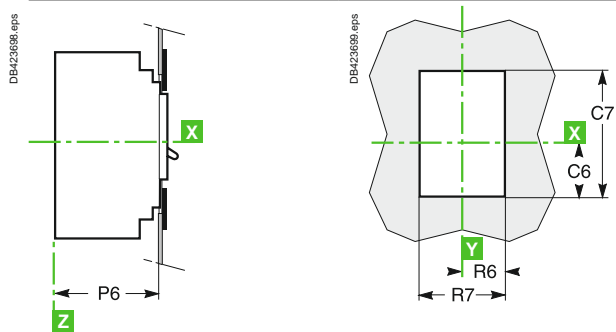

Dimensions (mm)

Type	C	C1	C2	C3	C6	C7	G	G1	G4	G5	H
NSX100/160 DC	29	76	54	108	43	104	62.5	125	70	140	80.5
Type	H1	H2	H3	H4	H6	H7	K	K1	L3	L4	L5
NSX100/160 DC	161	94	188	160.5	178.5	357	17.5	35	17.5	70	35
Type	P1	P2	P4	P5	P6	R	R1	R2	R4	R5	R6
NSX100/160 DC	81	86	111	83	88	14.5	29	19	38	73	29
Type	R7	ØT	ØT4	U							
NSX100/160 DC	58	6	22	≤ 32							

Dimensions and connection

Dimensions and mounting

Compact NSX100 to 1200 DC fixed version

Dimensions

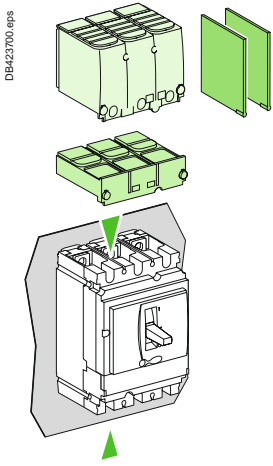

- Interphase barriers.
- Short terminal shields.

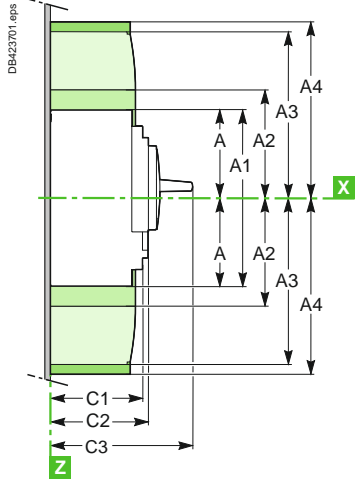

3P

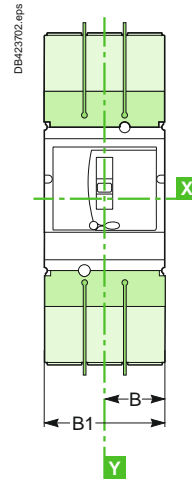

4P, 2P (4P circuit breaker platform)

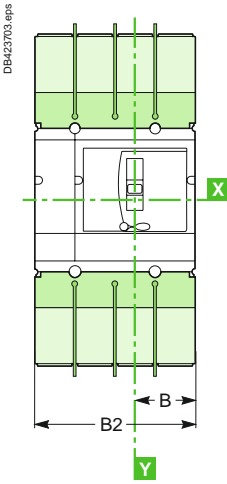

Long terminal shields (also available for NSX400/630 DC spreaders with 52.5 mm pitch: B1 = 157.5 mm, B2 = 210 mm).

Mounting

On backplate

NSX100 to 250 DC

3P

NSX400/630 DC

3P

NSX100 to 1200 DC

4P, 2P (4P circuit breaker platform)

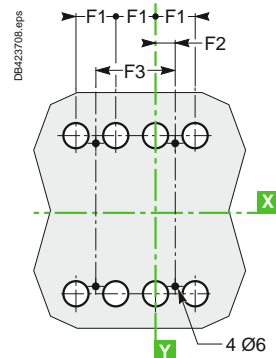
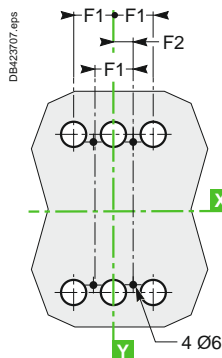
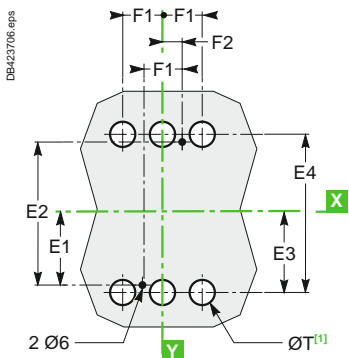
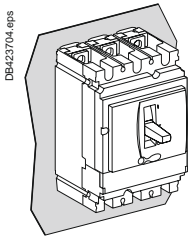

[1] The ØT holes are required for rear connection only.

On rails

3P

3P

4P, 2P (4P circuit breaker platform)

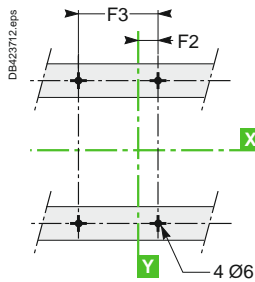
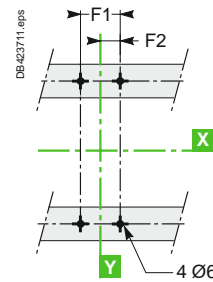
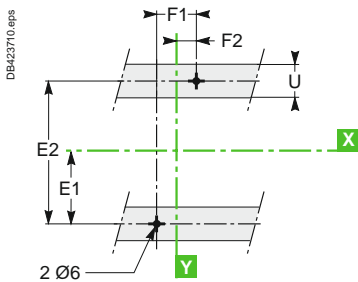
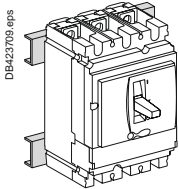

Dimensions and mounting

Compact NSX100 to 1200 DC fixed version

On DIN rail with adapter plate (NSX100 to 250 DC)

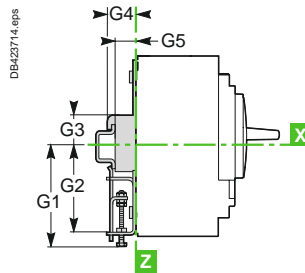
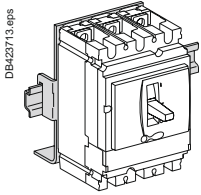

Dimensions (mm)

Type	A	A1	A2	A3	A4	B	B1	B2	C1	C2	C3
NSX100/160/250 DC	80.5	161	94	145	178.5	52.5	105	140	81	86	126
NSX400/630 DC	127.5	255	142.5	200	237	70	140	185	95.5	110	168
NSX1200 DC	-	-	-	240	-	70	-	185	95.5	110	168
Type	E1	E2	F1	F2	F3	G1	G2	G3	G4	G5	
NSX100/160/250 DC	62.5	125	35	17.5	70	95	75	13.5	23	17.5	
NSX400/630 DC	100	200	45	22.5	90	-	-	-	-	-	
NSX1200 DC	100	200	-	22.5	90	-	-	-	-	-	



Dimensions and connection

Dimensions and mounting

Compact NSX100 to 630 DC plug-in version

Dimensions

3P

4P

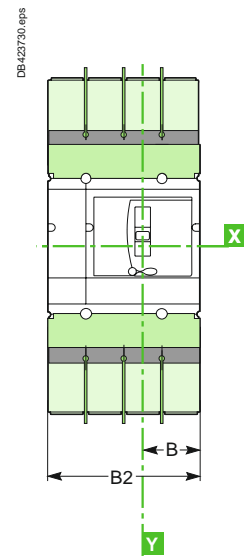
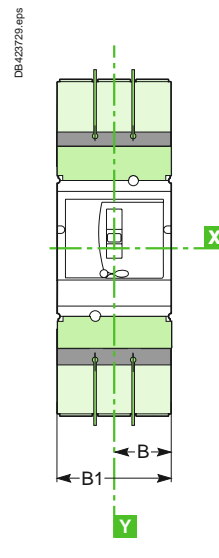
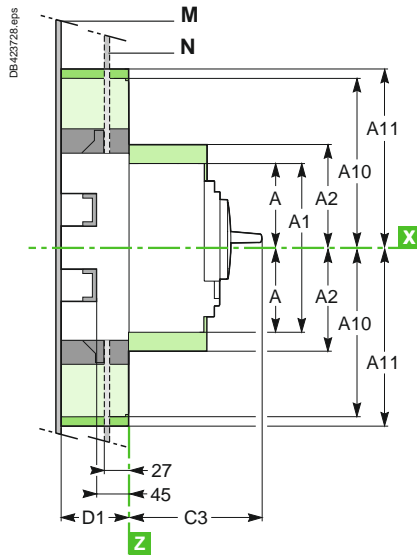
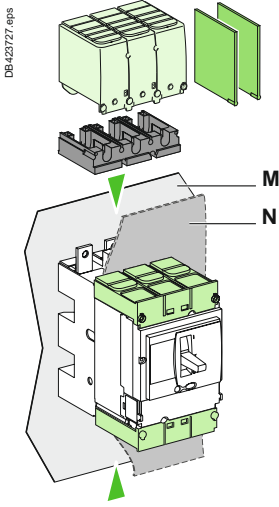

Interphase barriers for base.

Short terminal shields on circuit breaker.

Long terminal shields (also available for NSX400/630 DC spreaders with 52.5 mm pitch:
B1 = 157.5 mm, B2 = 210 mm)

Adapter for base, required to mount long terminal shields or interphase barriers.

Mounting

Through front panel (N)

3P NSX100 to 250 DC

3P NSX400/630 DC

4P NSX100 to 630 DC

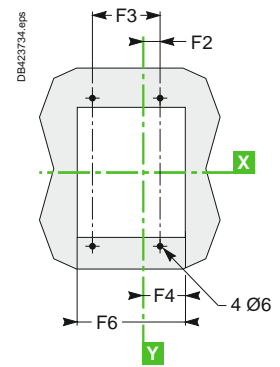
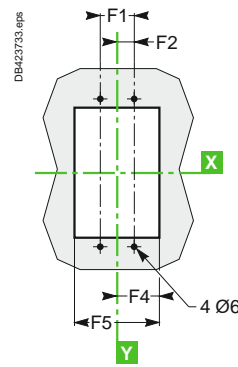
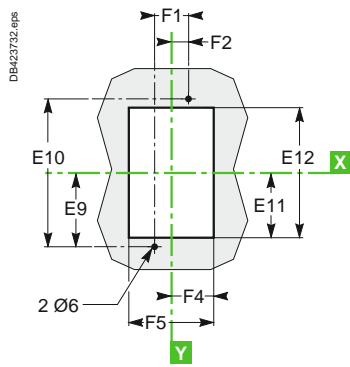
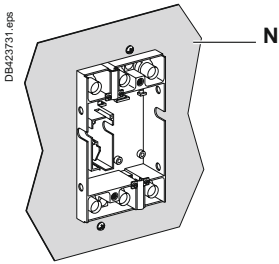

Dimensions and connection

Dimensions and mounting

Compact NSX100 to 630 DC plug-in version

On backplate (M)

3P

4P

Front connection (an insulating screen is supplied with the base and must be fitted between the base and the backplate)

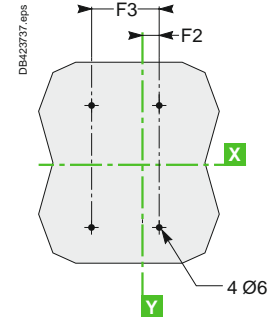
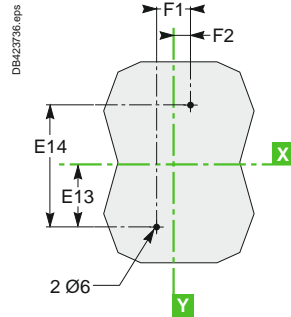
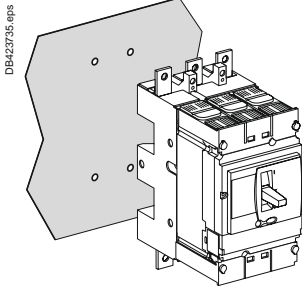

Connection by exterior-mounted rear connectors

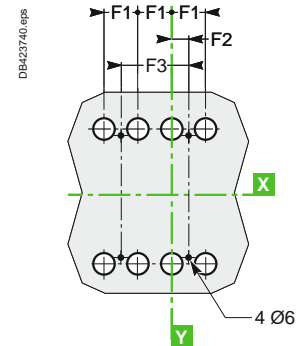
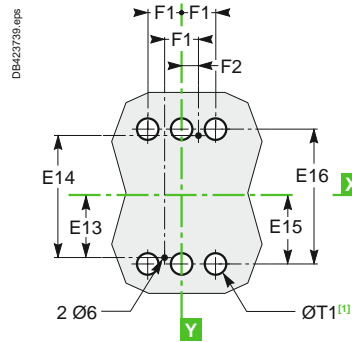
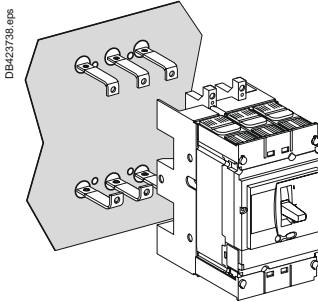

[1] The ØT1 holes are required for rear connection only.

Connection by interior-mounted rear connectors

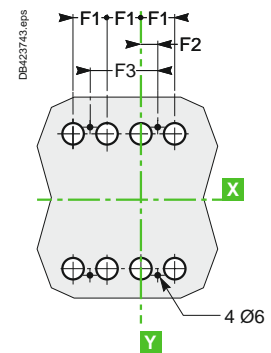
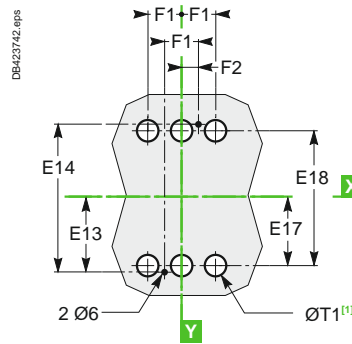
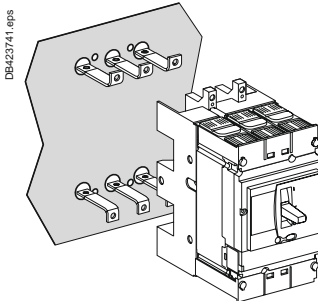

[1] The ØT1 holes are required for rear connection only.

On rails

3P

4P

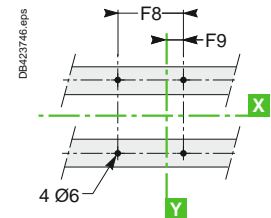
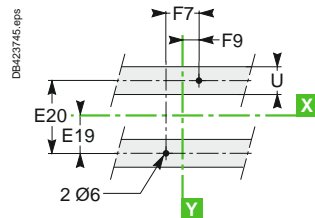
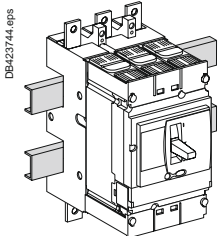

Type	A	A1	A2	A10	A11	B	B1	B2	C3	D1	E9	E10	E11	E12	E13	E14	E15
NSX100/160/250 DC	80.5	161	94	175	210	52.5	105	140	126	75	95	190	87	174	77.5	155	79
NSX400/630 DC	127.5	255	142.5	244	281	70	140	185	168	100	150	300	137	274	125	250	126
Type	E16	E17	E18	E19	E20	F1	F2	F3	F4	F5	F6	F7	F8	F9	ØT1	U	
NSX100/160/250 DC	158	61	122	37.5	75	35	17.5	70	54.5	109	144	70	105	35	24	≤ 32	
NSX400/630 DC	252	101	202	75	150	45	22.5	90	71.5	143	188	100	145	50	33	≤ 35	



Dimensions and connection

Dimensions and mounting

Compact NSX100 to 630 DC withdrawable version

Dimensions

3P

4P

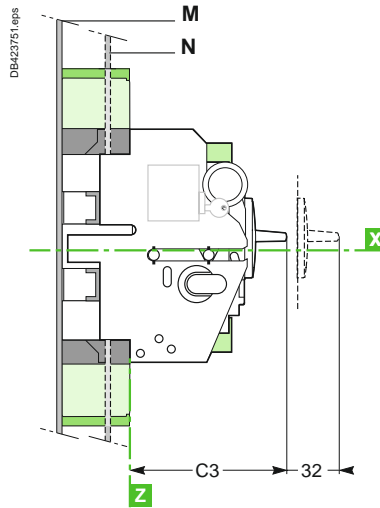
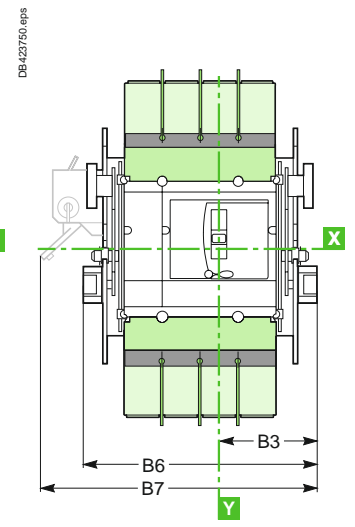
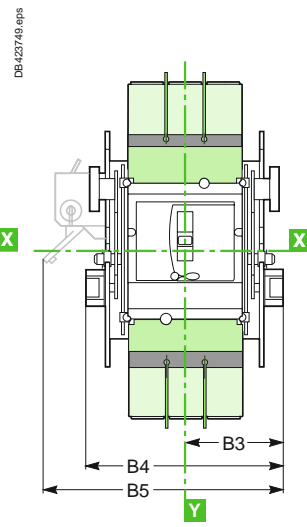
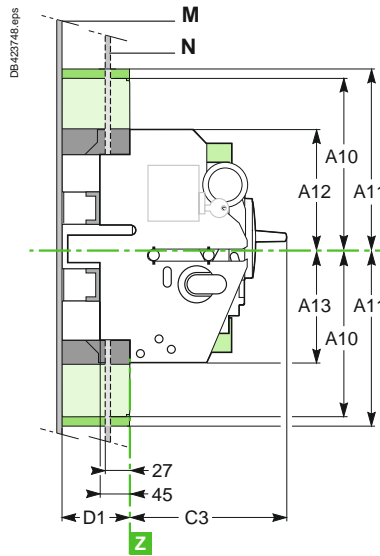
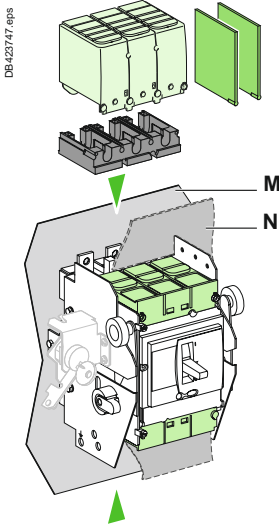

- Interphase barriers for base.
- Short terminal shields on circuit breaker.
- Long terminal shields.
- Adapter for base, required to mount long terminal shields or interphase barriers.

Mounting

Through front panel (N) 3P

3P

4P

NSX100 to 250 DC

NSX400/630 DC

NSX100 to 630 DC

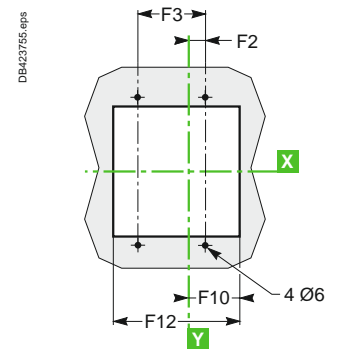
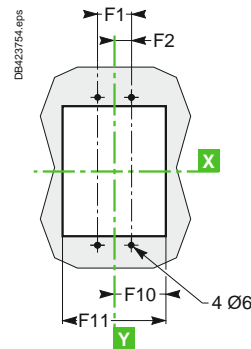
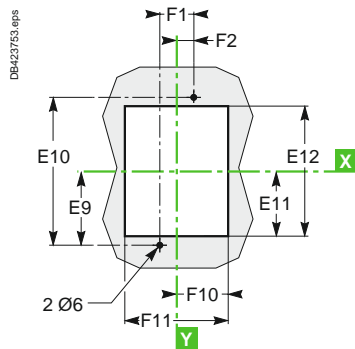
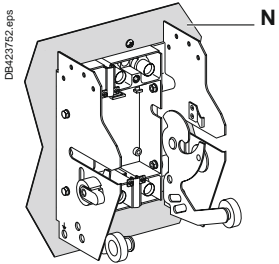

Dimensions and mounting

Compact NSX100 to 630 DC withdrawable version

On backplate (M)

3P

4P

Front connection (an insulating screen is supplied with the base and must be fitted between the base and the backplate)

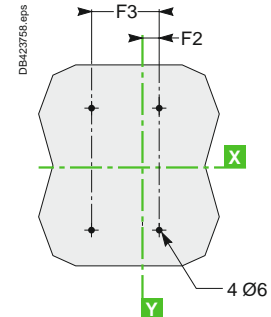
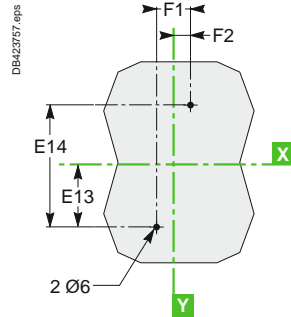
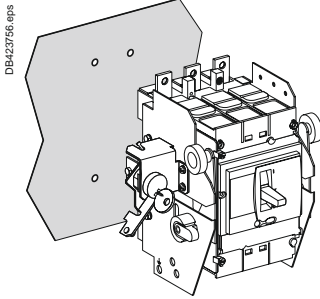

Connection by exterior-mounted rear connectors

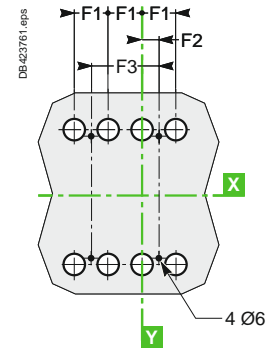
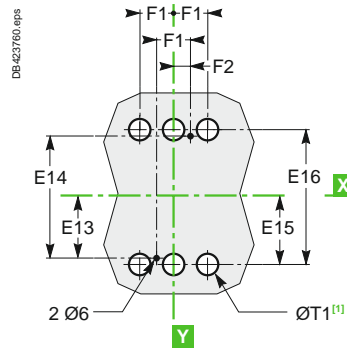
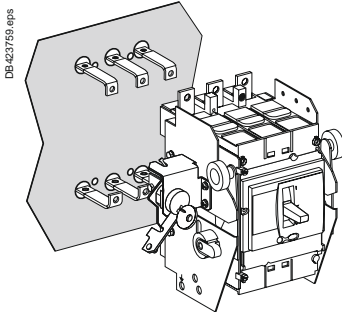

[1] The ØT1 holes are required for rear connection only.

Connection by interior-mounted rear connectors

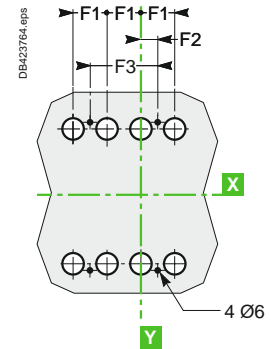
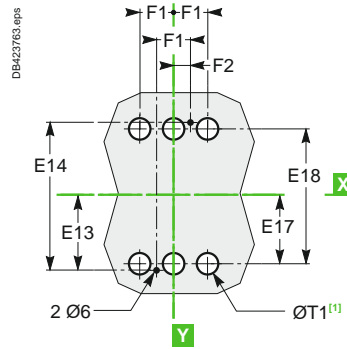
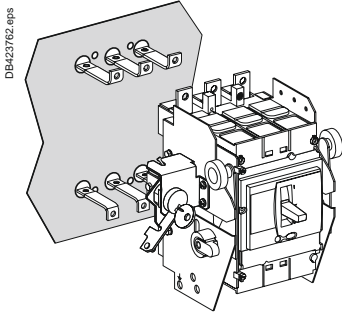

[1] The ØT1 holes are required for rear connection only.

On rails

3P

4P

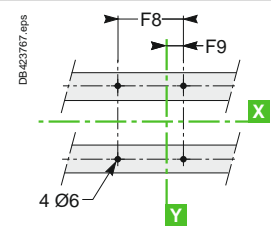
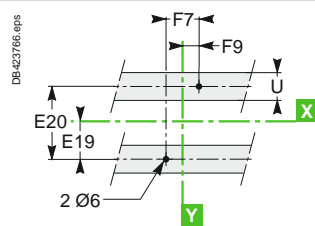
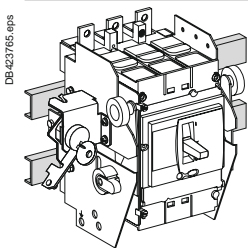

Type	A10	A11	A12	A13	B3	B4	B5	B6	B7	C3	D1	E9	E10	E11	E12	E13	E14
NSX100/160/250 DC	175	210	106.5	103.5	92.5	185	216	220	251	126	75	95	190	87	174	77.5	155
NSX400/630 DC	244	281	140	140	110	220	250	265	295	168	100	150	300	137	274	125	250
Type	E15	E16	E17	E18	E19	E20	F1	F2	F3	F7	F8	F9	F10	F11	F12	ØT1	U
NSX100/160/250 DC	79	158	61	122	37.5	75	35	17.5	70	70	105	35	74	148	183	24	≤ 32
NSX400/630 DC	126	252	101	202	75	150	45	22.5	90	100	145	50	91.5	183	228	33	≤ 35



Dimensions and mounting

Motor mechanism module for Compact NSX100 to 1200 DC

Dimensions

3P

4P, 2P(4P circuit breaker platform)

Fixed circuit breaker

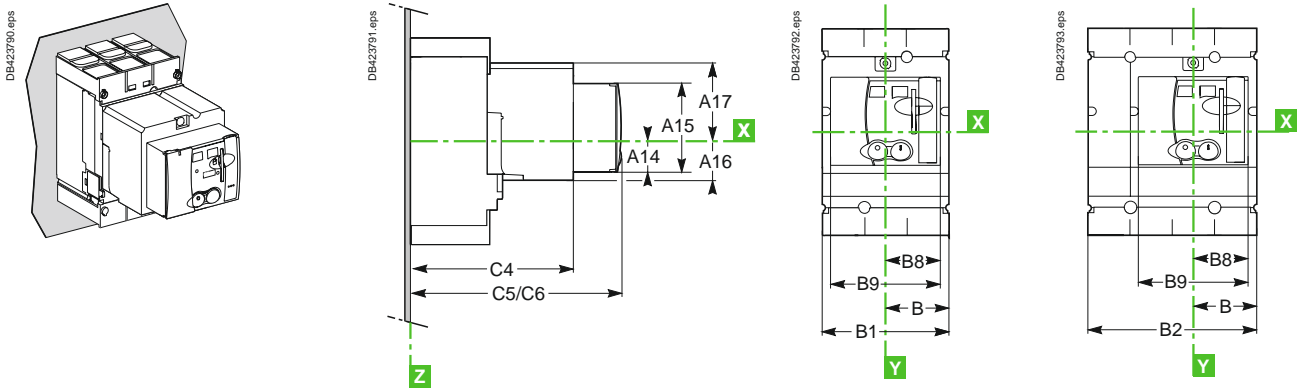

C5: without keylock
C6: with keylock

Plug-in circuit breaker

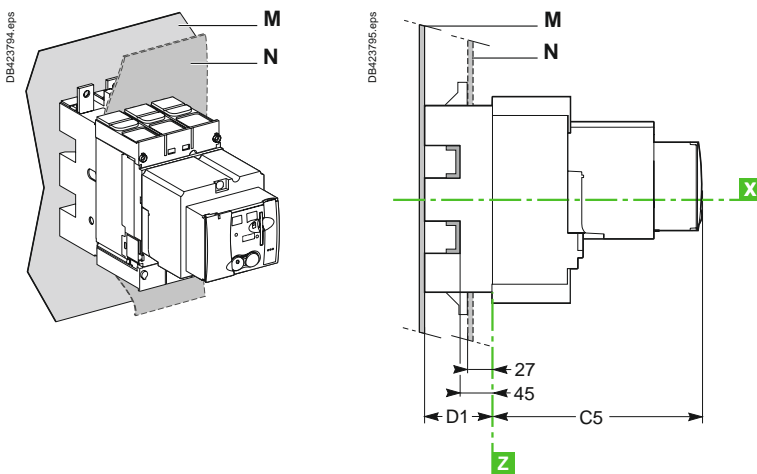

Withdrawable circuit breaker

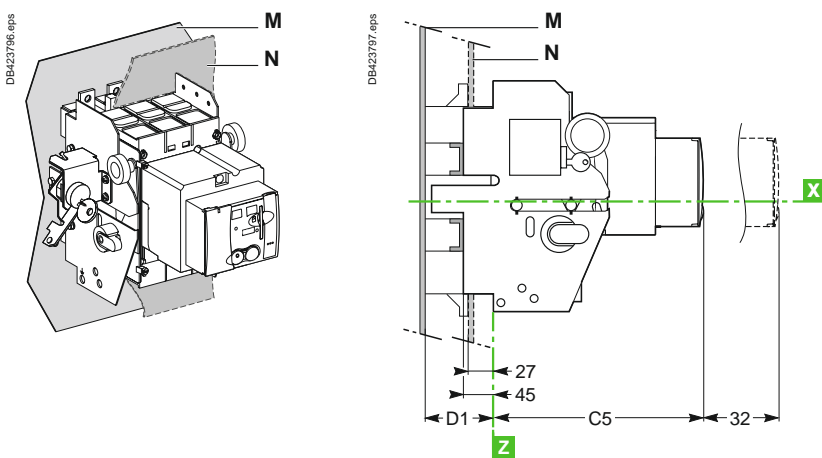

Type	A14	A15	A16	A17	B	B1	B2	B8	B9	C4	C5	C6	D1
NSX100/160/250 DC	27.5	73	34.5	62.5	52.5	105	140	45.5	91	143	182	209.5	75
NSX400/630 DC	40	123	52	100	70	140	185	61.5	123	215	256	258	100
NSX1200 DC	40	123	52	100	70	140	185	61.5	123	215	-	258	-

Dimensions and mounting

Direct rotary handle for Compact NSX100 to 1200 DC

Dimensions

3P

4P, 2P (4P circuit breaker platform)

Fixed circuit breaker

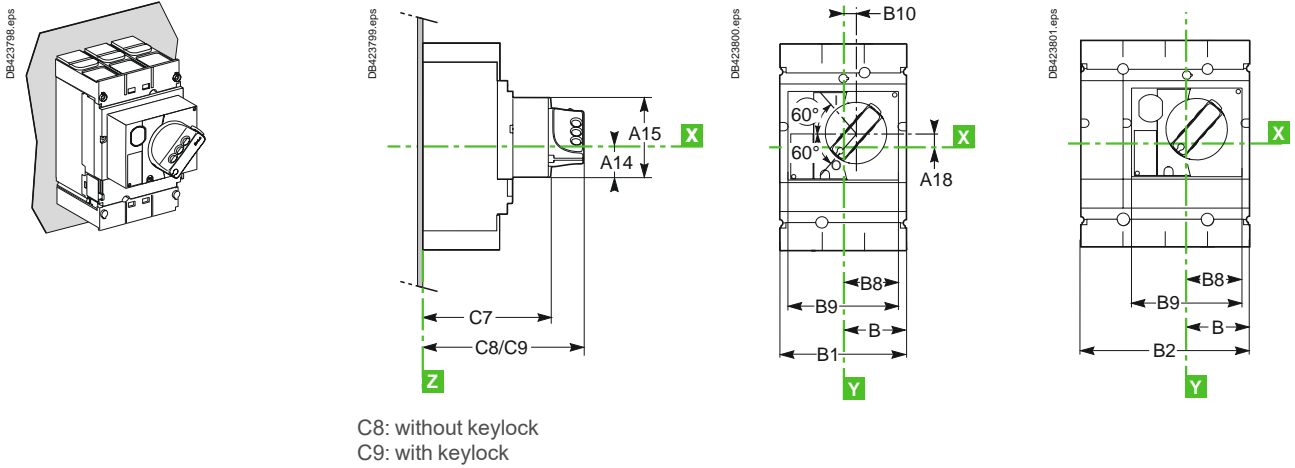

Plug-in circuit breaker

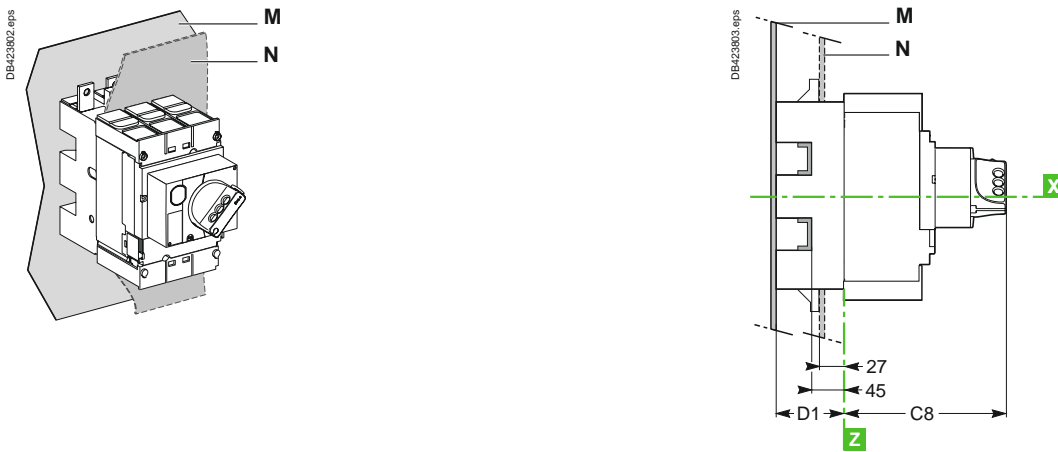

Withdrawable circuit breaker

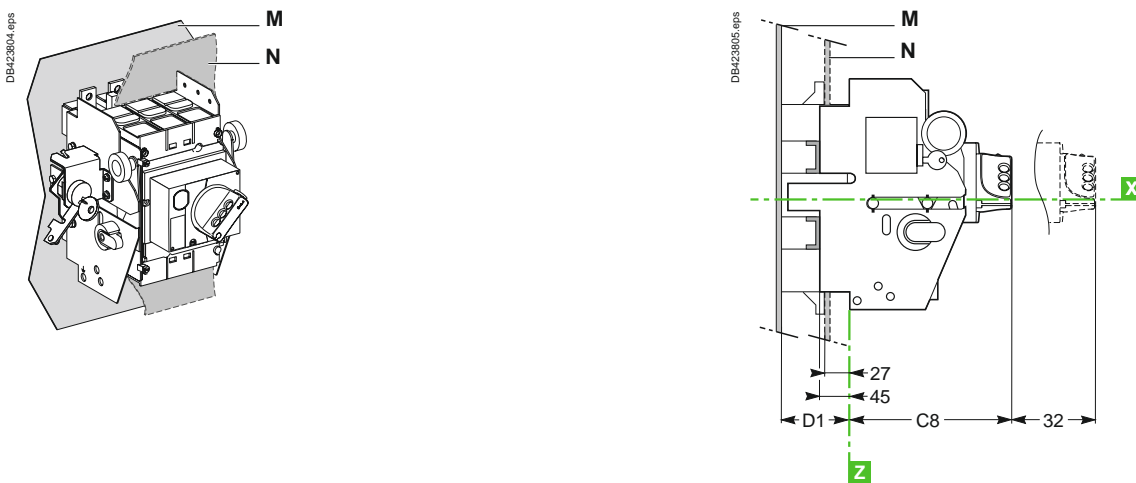

Type	A14	A15	A18	B	B1	B2	B8	B9	B10	C7	C8	C9	D1
NSX100/160/250 DC	27.5	73	9	52.5	105	140	45.5	91	9.25	121	155	164	75
NSX400/630 DC	40	123	24.6	70	140	185	61.5	123	5	145	179	188	100
NSX1200 DC	40	123	24.6	70	140	185	61.5	123	5	145	-	188	-

Dimensions and connection

Dimensions and mounting

MCC and CNOMO type direct rotary handles for Compact NSX100 to 1200 DC fixed version

Dimensions

MCC type direct rotary handle

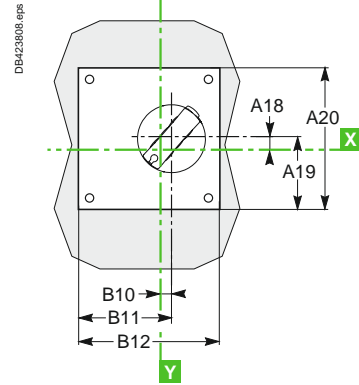
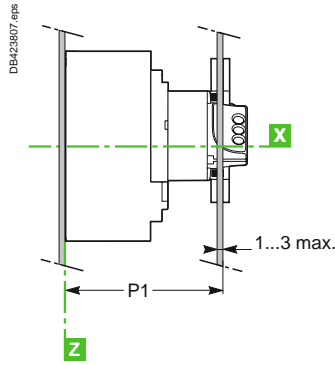
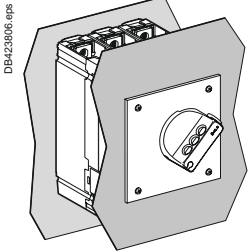

CNOMO type direct rotary handle

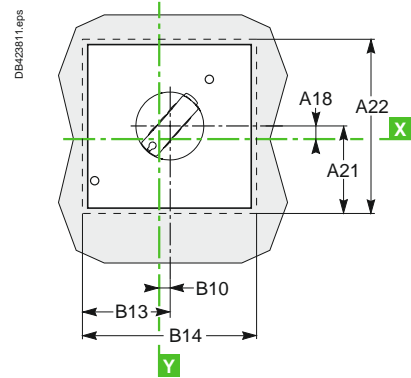
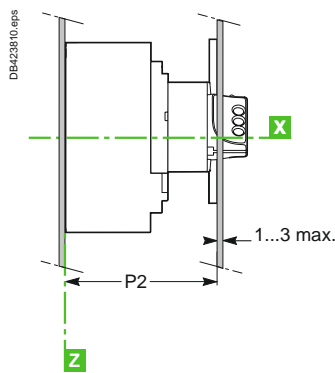
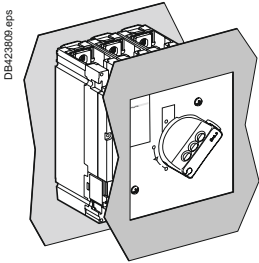

Front-panel cutout

MCC type direct rotary handle

NSX100 to 250 DC

NSX400/630/1200 DC

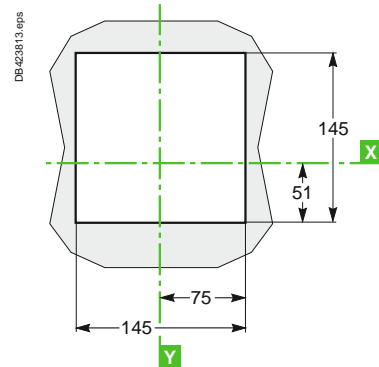
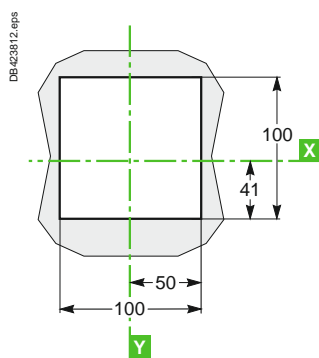
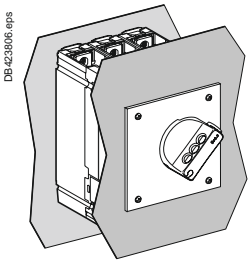

CNOMO type direct rotary handle

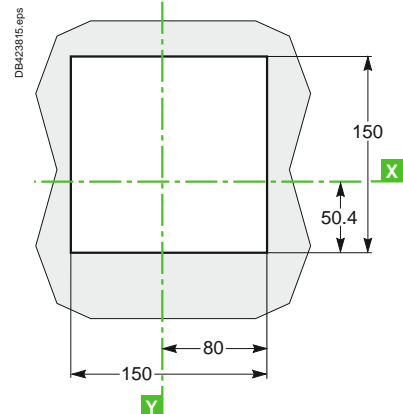
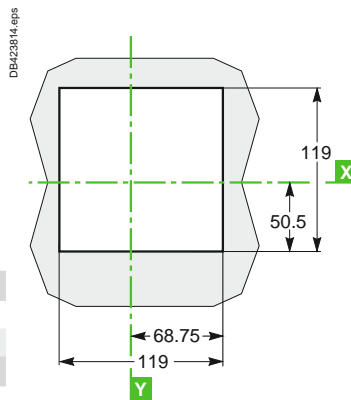
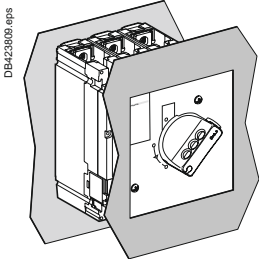

Type	A18	A19	A20	A21	A22	B10
NSX100/160/250 DC	9	60	120	65	130	9.25
NSX400/630/1200 DC	24.6	83	160	82	164	5
Type	B11	B12	B13	B14	P1	P2
NSX100/160/250 DC	69	120	65	130	125	135
NSX400/630/1200 DC	85	160	82	164	149	158

Dimensions and connection

Extended rotary handle for Compact NSX100 to 1200 DC

Dimensions

Fixed and plug-in circuit breakers

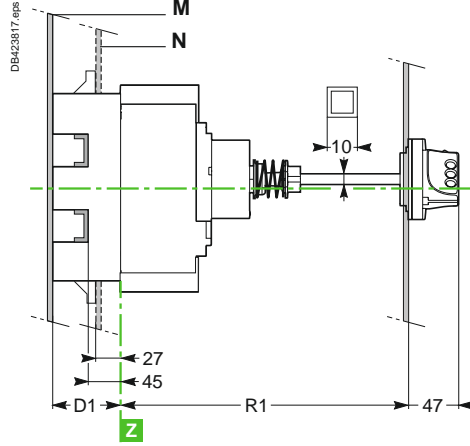
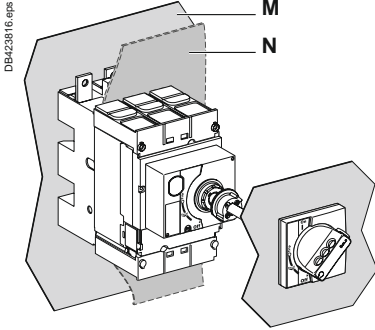

Cutout for shaft (mm)	
Type	R1
NSX100/160/250 DC	min. 171 max. 600
NSX400/630/1200 DC	min 195 max. 600

Withdrawable circuit breaker

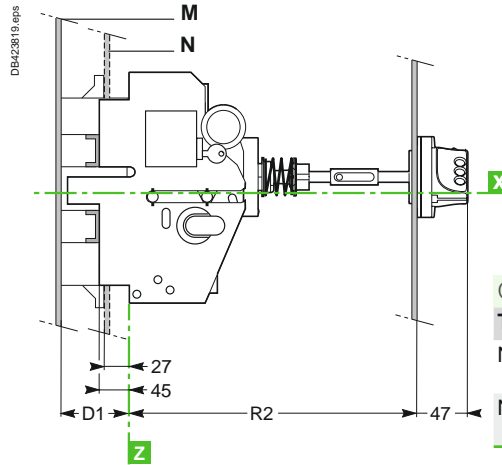
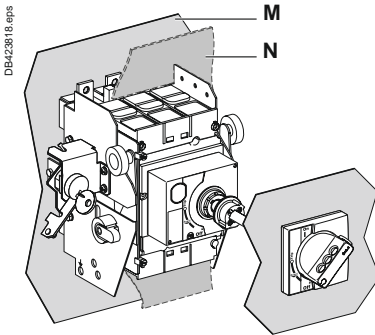

Cutout for shaft (mm)	
Type	R2
NSX100/160/250 DC	min. 248 max. 600
NSX400/630 DC	min. 272 max. 600

Dimensions and front-panel cutout

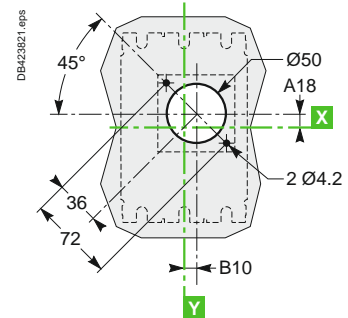
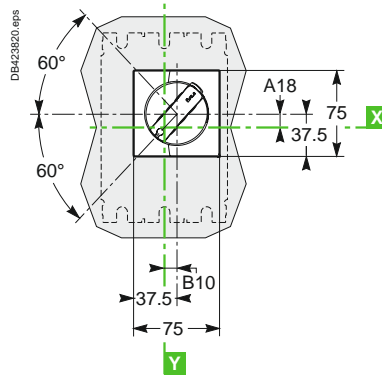

Type	A18	B10	D1
NSX100/160/250 DC	9	9.25	75
NSX400/630/1200 DC	24.6	5	100



Front-panel accessories

Compact NSX100 to 1200 DC

IP30 front-panel escutcheons

For toggle, rotary handle or motor mechanism module

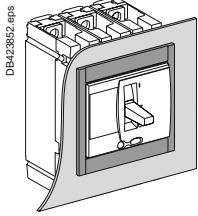

DB423852.eps

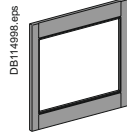

DB114938.eps

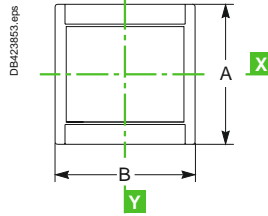

DB423853.eps



DB423854.eps

For toggle or rotary handle with access to trip unit

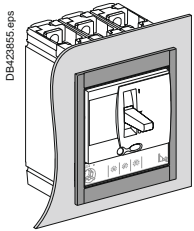

DB423855.eps

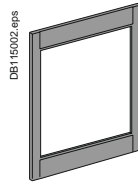

DB115002.eps

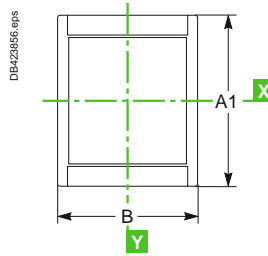

DB423856.eps



DB423857.eps

IP40 front-panel escutcheons

For toggle, rotary handle or motor mechanism module and protection collar

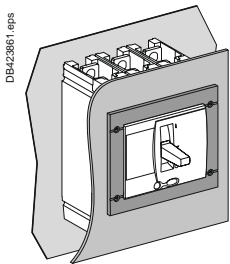

DB423861.eps

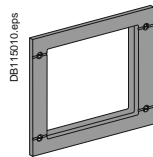

DB115010.eps

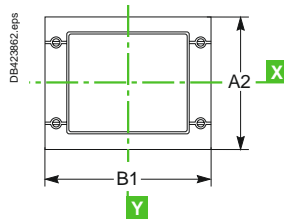

DB423862.eps

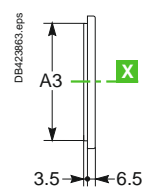

DB423863.eps

Protection collars for IP40 front-panel escutcheons

For toggle

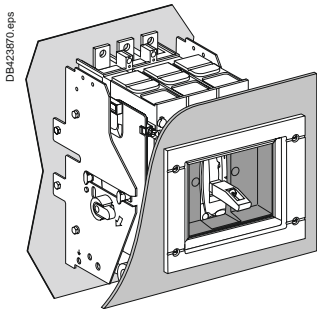

DB423870.eps

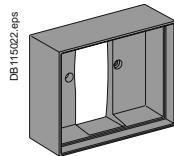

DB115022.eps

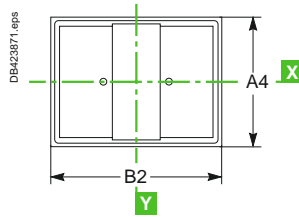

DB423871.eps

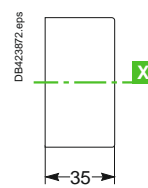

DB423872.eps

Dimensions and connection

Front-panel accessories

Compact NSX100 to 1200 DC

IP43 toggle cover

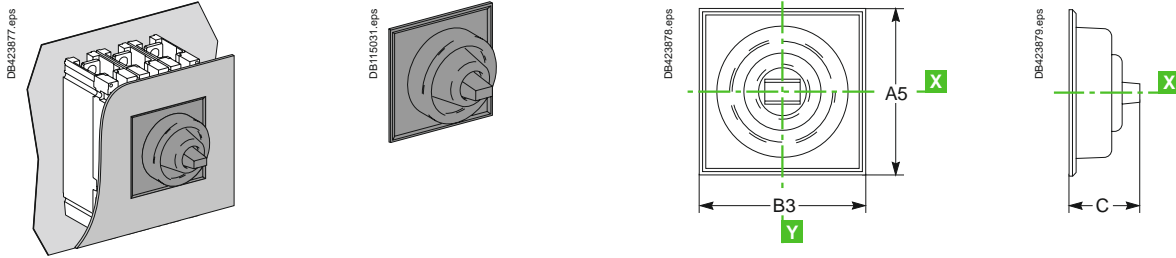

Type	A	A1	A2	A3	A4	A5	B	B1	B2	B3	C
NSX100/160/250 DC	113	138	114	101	73	85	113	157	91	103	40
NSX400/630/1200 DC	163	211	164	151	122.5	138	163	189	122.5	138	60



Power connections

Compact NSX100 to 1200 DC fixed version

Front connection without accessories

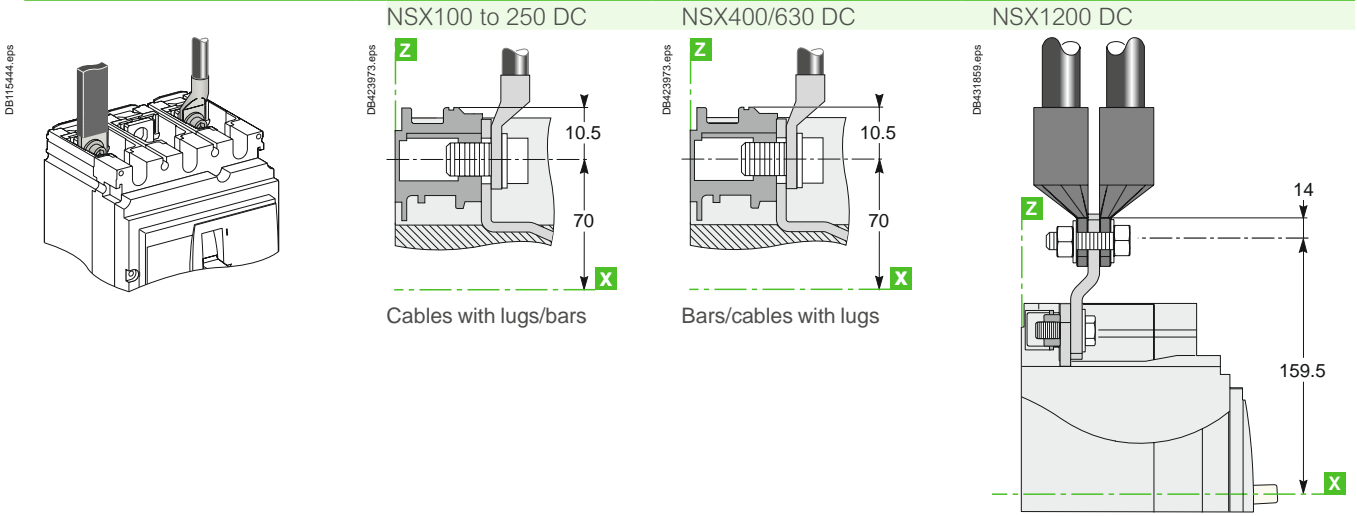

Connection with accessories

Long and short rear connectors

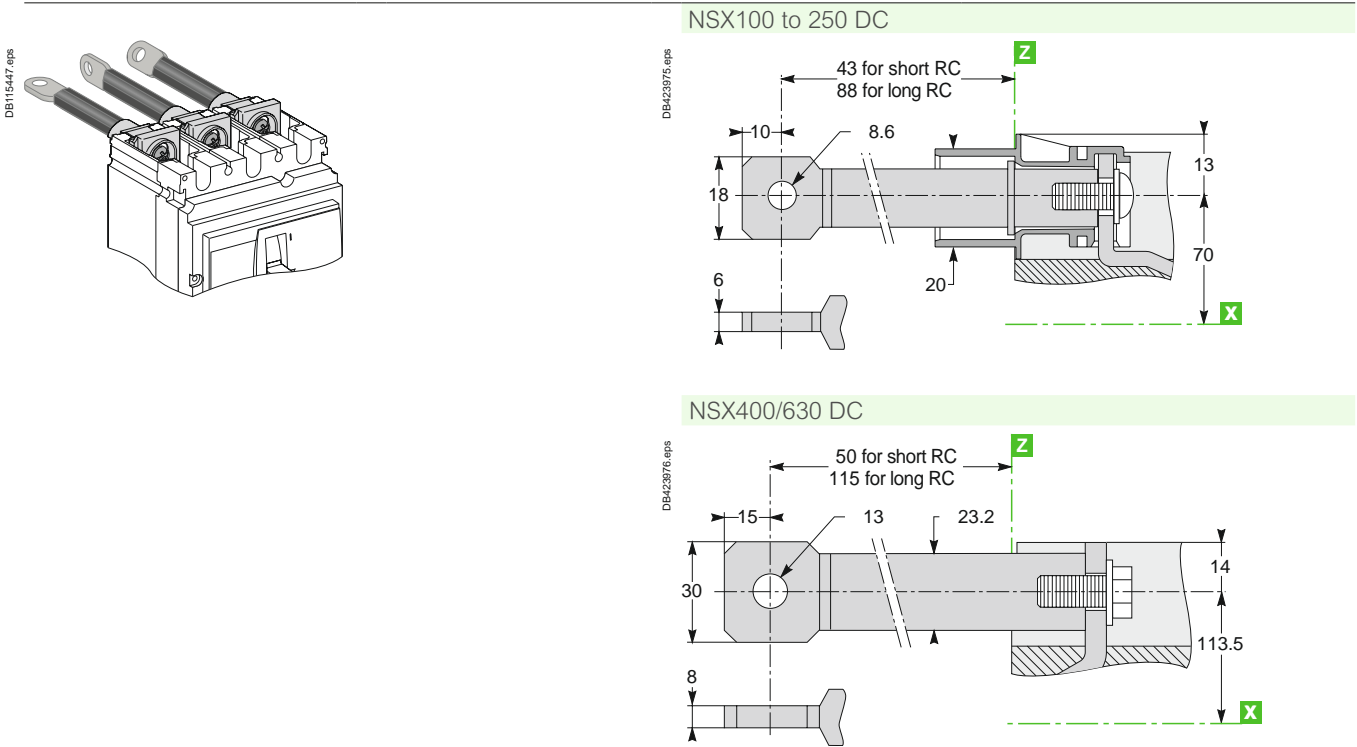

Bare-cable connectors

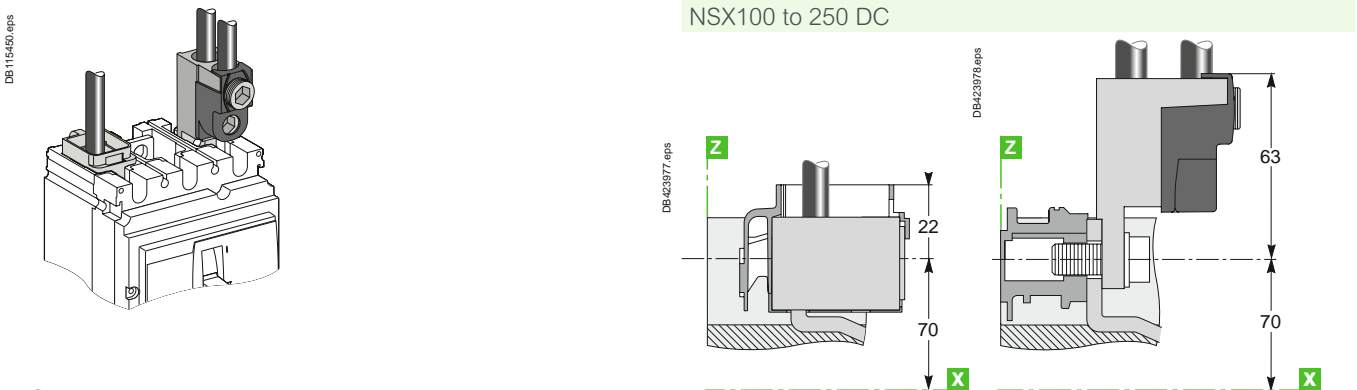

Dimensions and connection

Power connections

Compact NSX100 to 1200 DC fixed version

Connection with accessories (cont.)

Bare-cable connectors

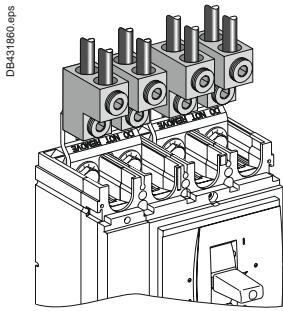
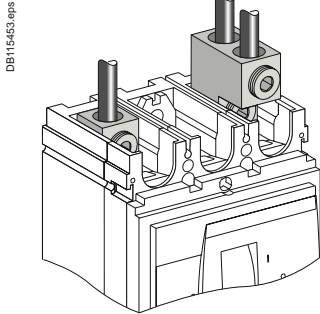

NSX400/1200 DC

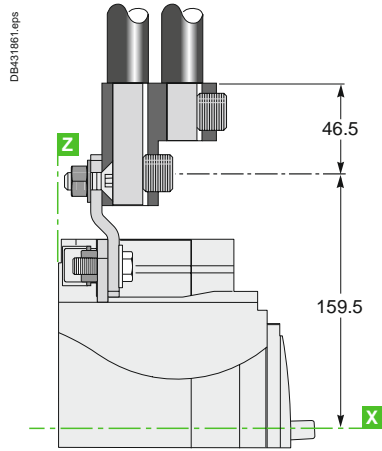
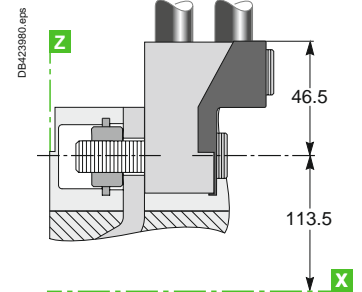
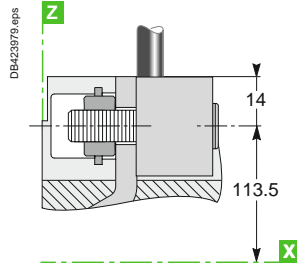

Distribution connectors (for NSX100 to 250 DC only)

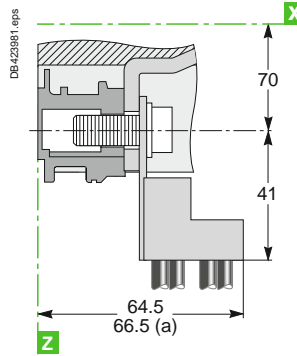
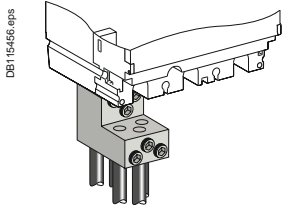

(a) NSX250 DC.

Right-angle terminal extensions (upstream only)

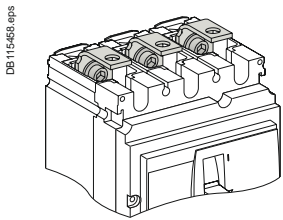

NSX100 to 250 DC

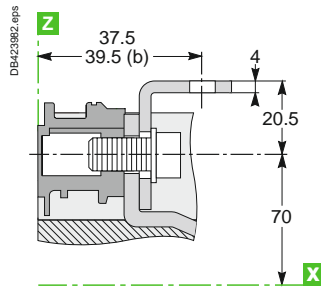

(b) NSX250 DC.

NSX400/630 DC

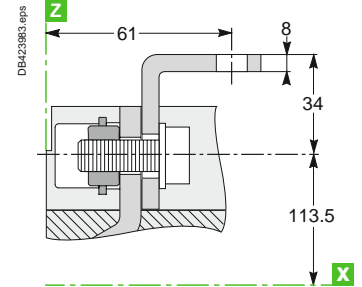

Power connections

Compact NSX100 to 630 DC fixed version

Connection with accessories (cont.)

Straight terminal extensions (for NSX100 to 250 DC only)

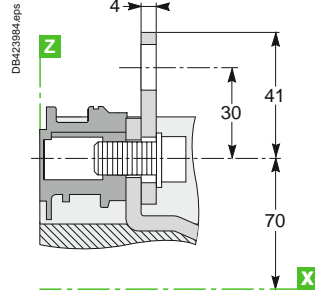
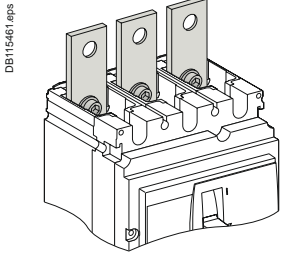

Edgewise terminal extensions

NSX100 to 250 DC

NSX400/630 DC

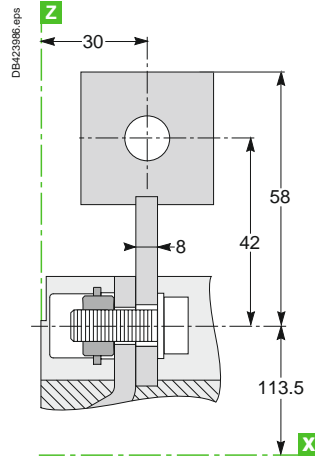
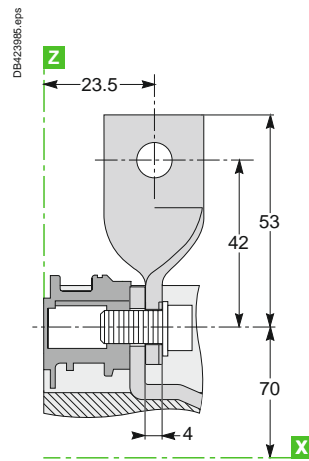
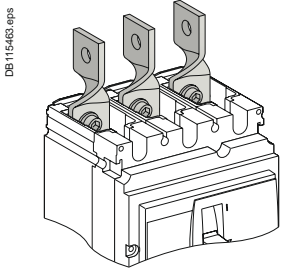

45° terminal extensions

NSX100 to 250 DC

NSX400/630 DC

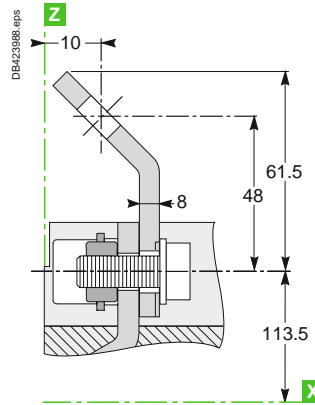
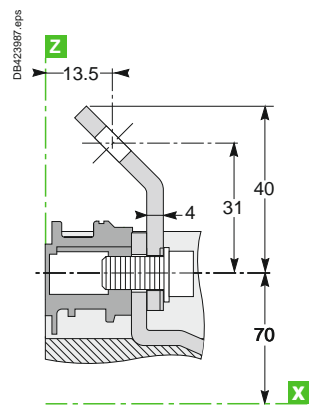
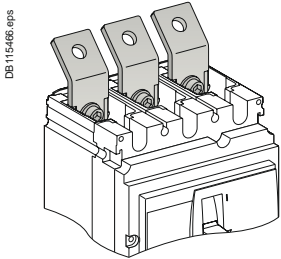

Double-L terminal extensions

NSX100 to 250 DC

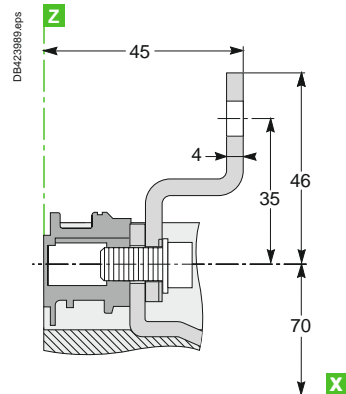
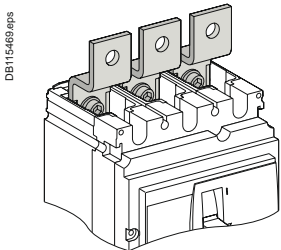

Dimensions and connection

Power connections

Compact NSX100 to 630 DC fixed version

Connection with accessories (cont.)

Spreaders

3P

4P

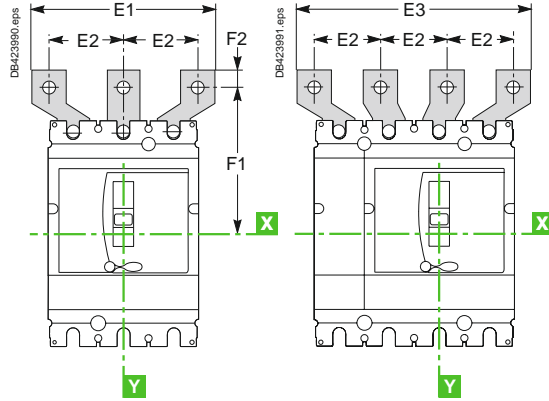
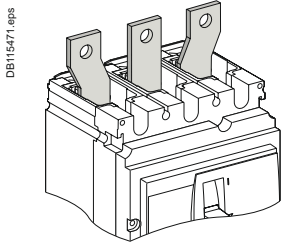

NSX100 to 250 DC

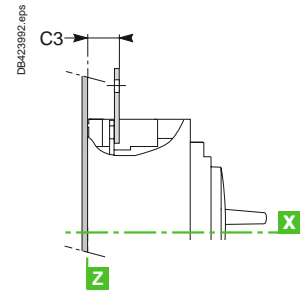

NSX400/630 DC

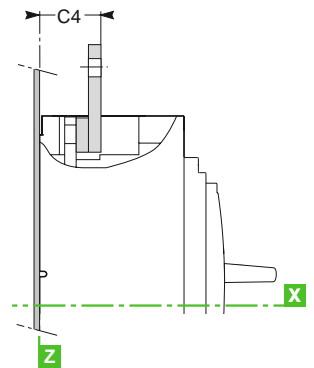

Type	C3	C4	E1	E2	E3	F1	F2
NSX100/160 DC	23.5	-	114	45	159	100	11
NSX250 DC	25.5	-	114	45	159	100	11
NSX400/630 DC	-	44	135	52.5	187.5	152.5	15
			170	70	240	166	15

One-piece spreader (for NSX100 to 250 only)

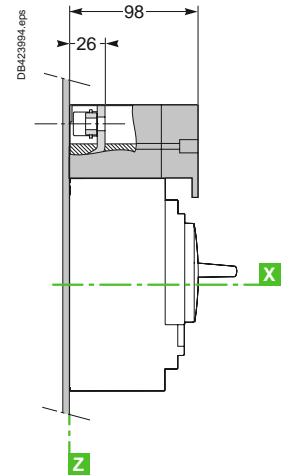
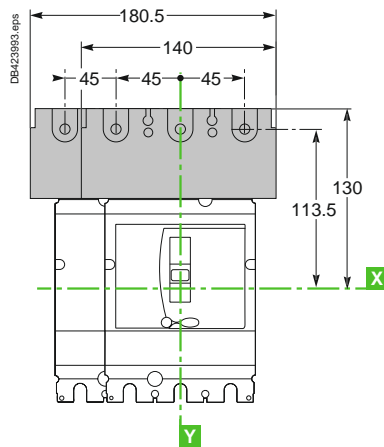
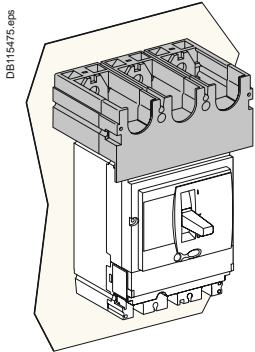

Dimensions and connection

Power connections

Connection of insulated bars or cables with lugs to Compact NSX100 to 1200 DC

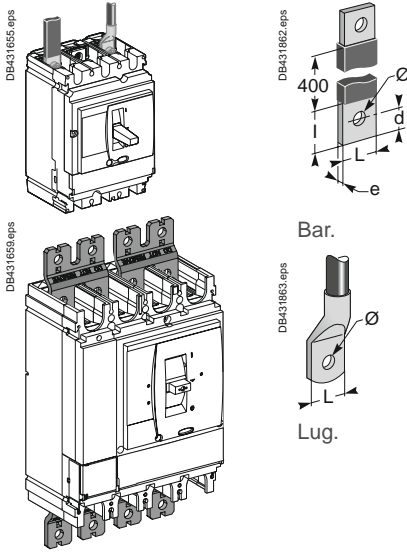

Direct connection to NSX100 to 1200 DC

Dimensions		NSX100 DC	NSX160/250 DC	NSX400/630/1200 DC
Bars	L (mm)	≤ 25	≤ 25	≤ 32
	l (mm)	d + 10	d + 10	d + 15
	d (mm)	≤ 10	≤ 10	≤ 15
	e (mm)	≤ 6	≤ 6	3 ≤ e ≤ 10
	Ø (mm)	6.5	8.5	10.5
Lugs	L (mm)	≤ 25	≤ 25	≤ 32
	Ø (mm)	6.5	8.5	10.5
Torque (Nm) [1]		10	15	50
Torque (Nm) [2]		5/5	5/5	20/11
Torque (Nm) [3]		8	8	20

- [1] Tightening torque on the circuit breaker for lugs or bars.
- [2] Tightening torque on fixed devices for rear connectors//tightening torque on plug-in or withdrawable devices for power connectors.
- [3] Tightening torque on the plug-in base for terminal extensions.

Connection with accessories to NSX100 to 250 DC (IEC 228)

Pole pitch			
Without spreaders		35 mm	
With spreaders		45 mm	
Dimensions		With spreaders or terminal extensions	
		NSX100 DC	NSX160/250 DC
Bars	L (mm)	≤ 25	≤ 25
	l (mm)	20 ≤ l ≤ 25	20 ≤ l ≤ 25
	d (mm)	≤ 10	≤ 10
	e (mm)	≤ 6	≤ 6
	Ø (mm)	6.5	8.5
Lugs	L (mm)	≤ 25	≤ 25
	Ø (mm)	6.5	8.5
Torque (Nm) [1]		10	15
Torque (Nm) [2]		5	5

- [1] Tightening torque on the circuit breaker for spreaders or terminal extensions.
 - [2] Tightening torque on the plug-in base for spreaders or terminal extensions.
- Spreaders and straight, right-angle, 45°, double-L and edgewise terminal extensions are supplied with flexible interphase barriers.

Connection with accessories to NSX400 DC and 630 DC (IEC 228)

Pole pitch			
Without spreaders		45 mm	
With spreaders		52.5 or 70 mm	
Dimensions		With spreaders	With terminal extensions
Bars	L (mm)	≤ 40	≤ 32
	l (mm)	d + 15	30 ≤ l ≤ 34
	d (mm)	≤ 20	≤ 15
	e (mm)	3 ≤ e ≤ 10	3 ≤ e ≤ 10
	Ø (mm)	12.5	10.5
	Ø (mm)	12.5	10.5
Lugs	L (mm)	≤ 40	≤ 32
	Ø (mm)	12.5	10.5
Torque (Nm) [1]		50	50
Torque (Nm) [2]		20	20

- [1] Tightening torque on the circuit breaker for spreaders or terminal extensions.
 - [2] Tightening torque on the plug-in base for spreaders or terminal extensions.
- Spreaders and right-angle, 45° and edgewise terminal extensions are supplied with flexible interphase barriers.

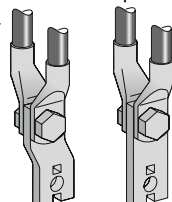

Mounting detail: 2 cables with lugs.

Accessories for NSX100 to 250 DC

Straight terminal extensions Double-L terminal extensions

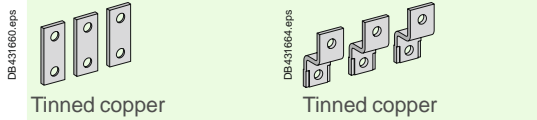

Separate parts One-piece spreader

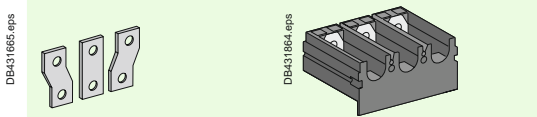

Tinned copper
For U > 600 V, the mandatory insulation kit is not compatible with spreaders made up of separate parts.

Accessories for NSX400 and 630 DC
Spreaders made up of separate parts for 52.5 and 70 mm pitch

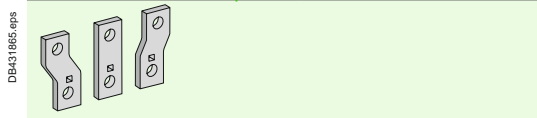

Tinned copper
For U > 600 V, use of the 52.5 mm pitch spreaders requires a specific insulation kit.
The 70 mm pitch spreaders may not be used.

Accessories for NSX100 to 630 DC
Right-angle terminal extensions Edgewise terminal extensions

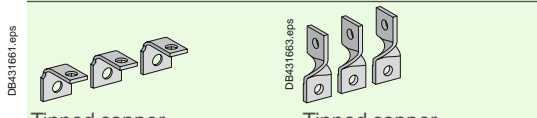

Tinned copper
To be mounted on upstream side.

45° terminal extensions

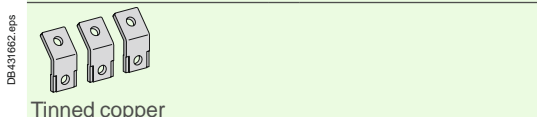

Tinned copper



Power connections

Connection of bare cables to Compact NSX100 to 1200 DC

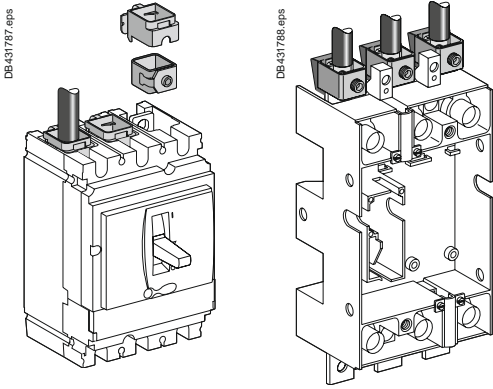

Connection for NSX100 to 250 DC

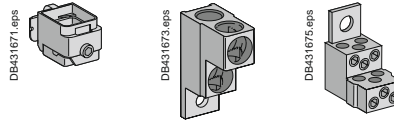

1-cable connector 2-cable connector Distribution connector

	1-cable connector	Steel ≤ 160 A	Aluminium ≤ 250 A	
L (mm)	25	25		
S (mm ²) Cu / Al	1.5 to 95 ^[1]	25 to 50	70 to 95	120 to 185 150 max. flex.
Torque (Nm)	12	20	26	26
2-cable connector				
L (mm)	25 or 50			
S (mm ²) Cu / Al	2 x 50 to 2 x 120			
Torque (Nm)	22			
6-cable distribution connector (copper or aluminium)				
L (mm)	15 or 30			
S (mm ²) Cu / Al	1.5 to 6 ^[1]	8 to 35		
Torque (Nm)	4	6		

[1] For flexible cables from 1.5 to 4 mm², connection with crimped or self-crimping ferrules.

Connection for NSX400 and 630 DC



1-cable connector 2-cable connector

	1-cable connector	2-cable connector
L (mm)	30	30 or 60
S (mm ²) Cu / Al	35 to 300 rigid 240 max. flex.	2 x 35 to 2 x 240 rigid 240 max. flex.
Torque (Nm)	31	31

Connection for NSX630 and 1200 DC

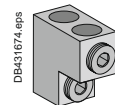

2-cable connector

	2-cable connector
L (mm)	30 or 60
S (mm ²) Cu / Al	2 x 35 to 2 x 240 rigid 240 max. flex.
Torque (Nm)	31

Conductor materials and electrodynamic stresses

Compact NSX DC circuit breakers can be connected indifferently with bare-copper, tinned-copper and tinned-aluminium conductors (flexible or rigid bars, cables). In the event of a short-circuit, thermal and electrodynamic stresses will be exerted on the conductors. They must therefore be correctly sized and held in place by supports.

Electrical connection points on switchgear devices (switch-disconnectors, contactors, circuit breakers, etc.) should not be used for mechanical support. Any partition between upstream and downstream connections of the device must be made of non-magnetic material.



Dimensions and connection

Compact (fixed version) 2P-3P-4P

Parallel and series connection of poles

Compact NSX100 to NSX250 DC

2P fixed version (Compact NSX100-160 N/H DC) - 3P fixed version (Compact NSX100-250 DC)

With series connections

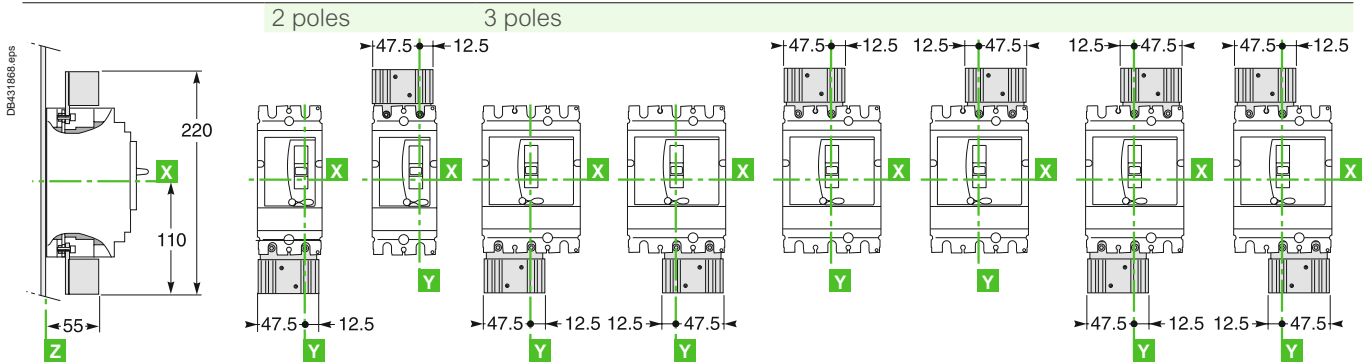

With parallel connections

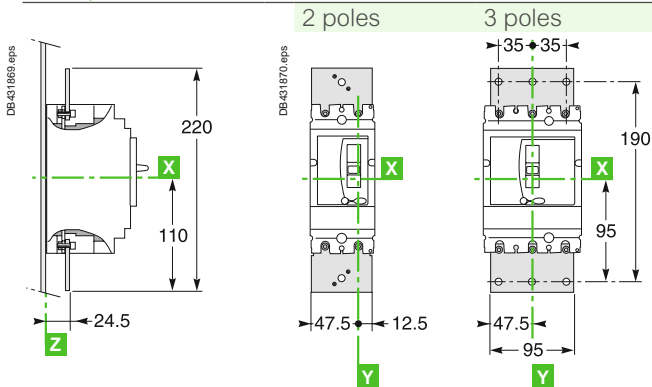

4P fixed version (Compact NSX100-250 DC)

With series connections

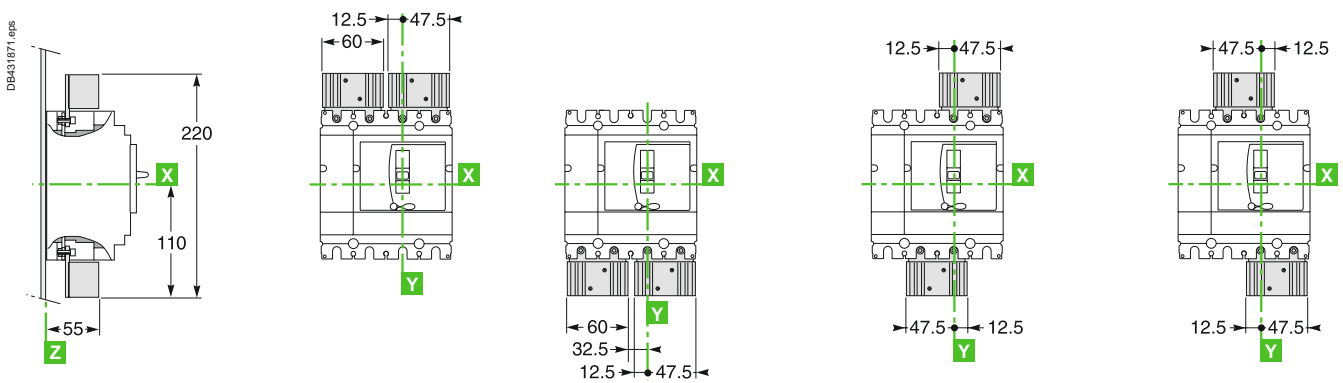

With parallel connections

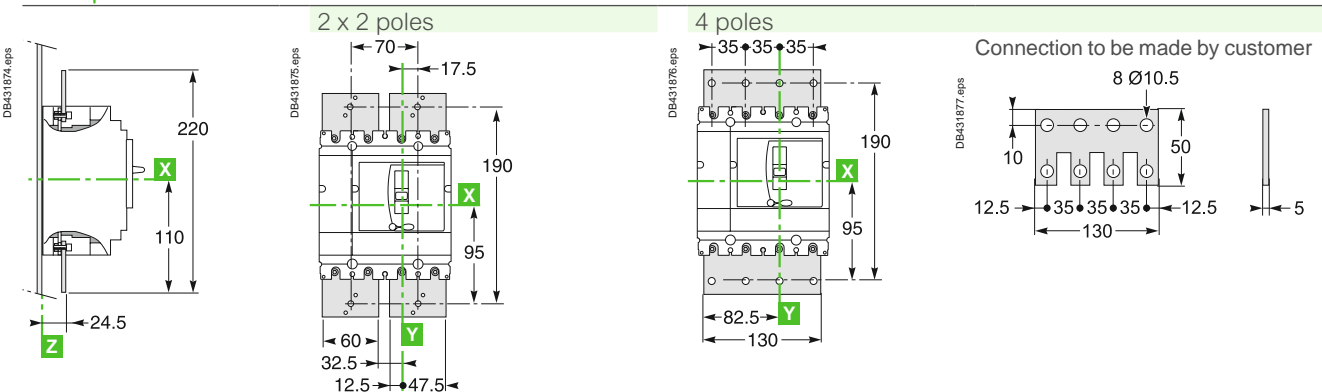

Compact (fixed version) 2P-3P-4P

Parallel and series connection of poles

Compact NSX400 to NSX630 DC

3P fixed version (Compact NSX400-630 DC)

With series connections

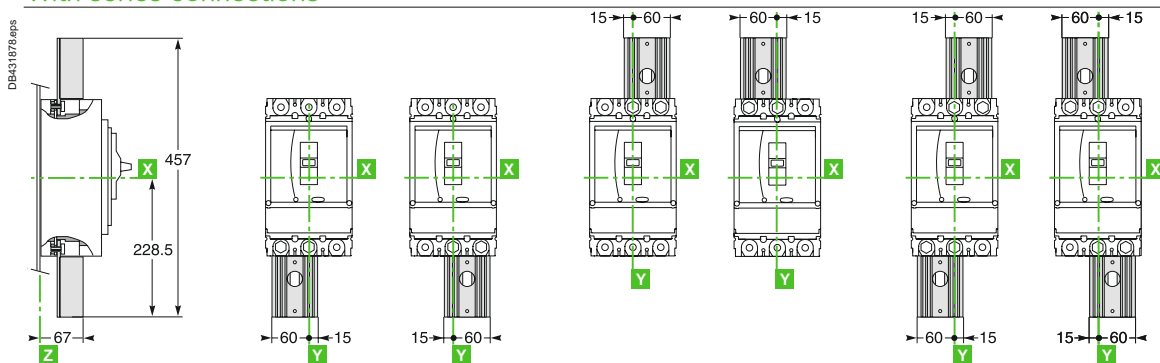

With parallel connections

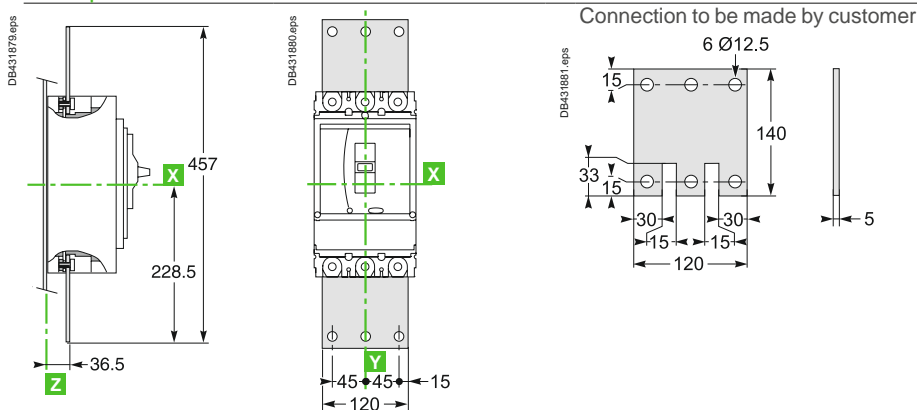

4P fixed version (Compact NSX400 to NSX630 DC)

With series connections

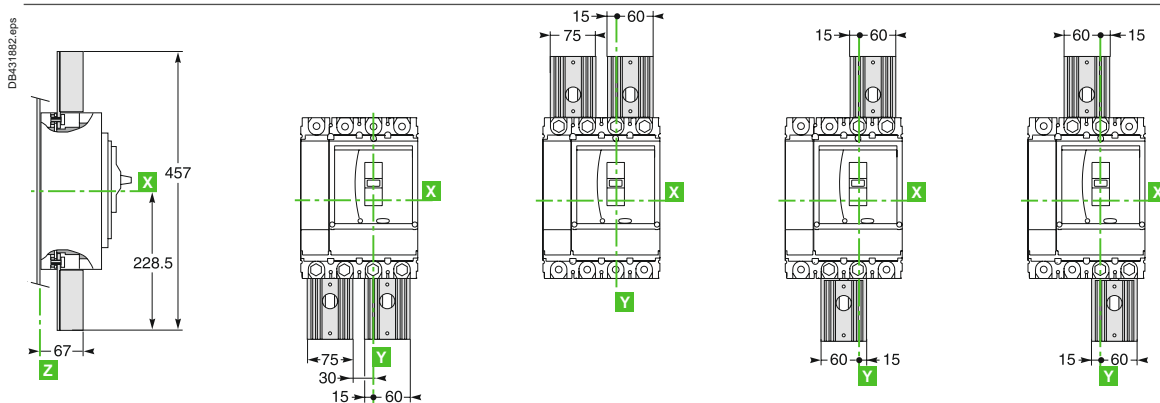

With parallel connections

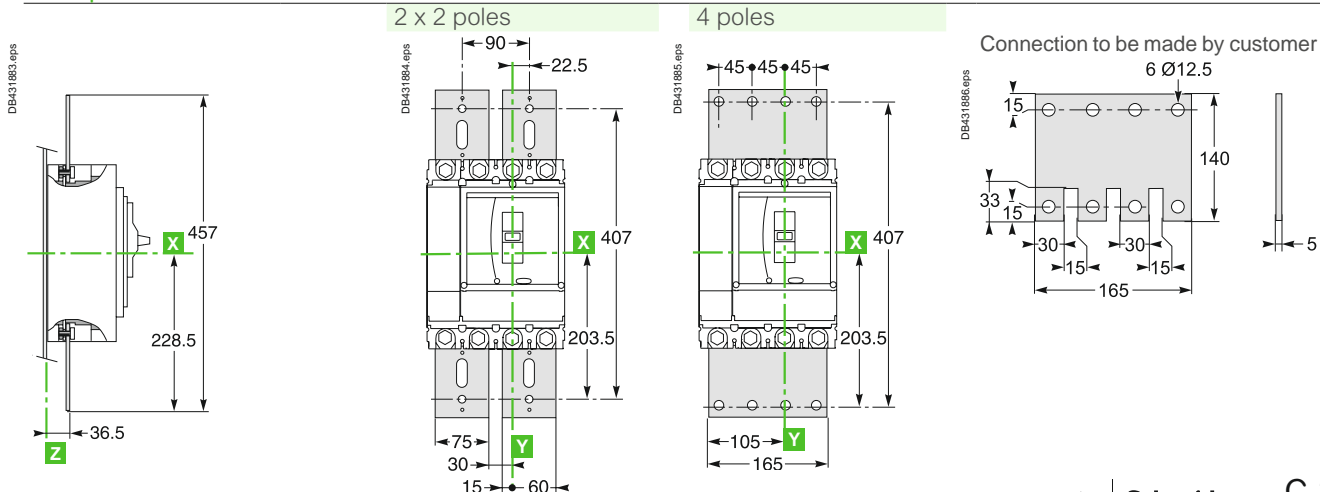

Dimensions and connection

Compact (fixed version) 4P Parallel and series connection of poles Compact NSX630 to NSX1200 DC

4P fixed version (Compact NSX630 to NSX1200DC)

With parallel connections

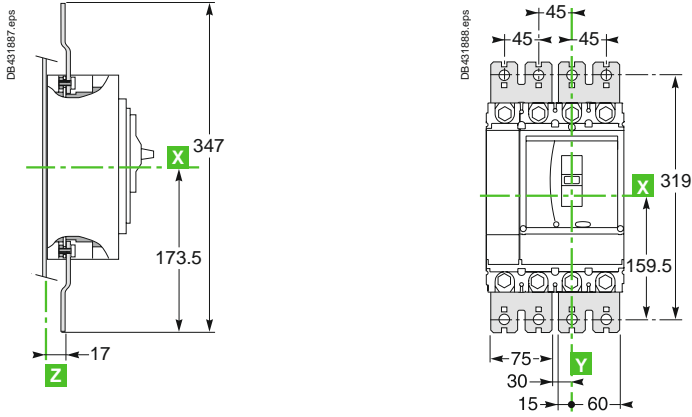

Compact (withdraw. version) 3P-4P Parallel and series connection of poles Compact NSX100 to NSX250 DC

3P withdrawable version

Connections mounted with heat sink directed outwards

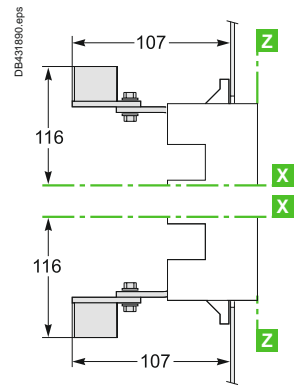
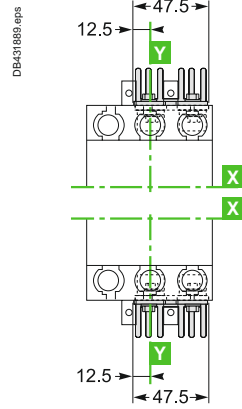
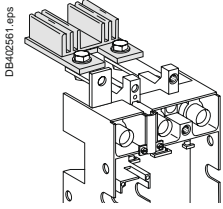

Connections mounted with heat sink directed inwards

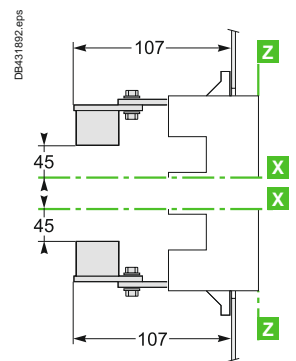
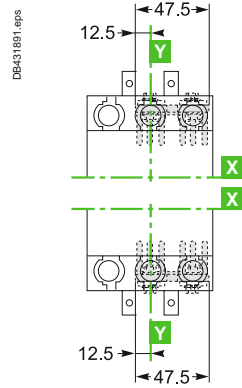
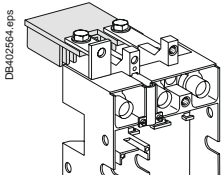

4P withdrawable version

Connections mounted with heat sink directed outwards

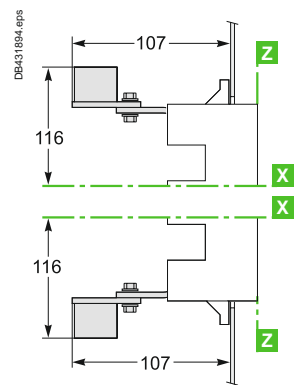
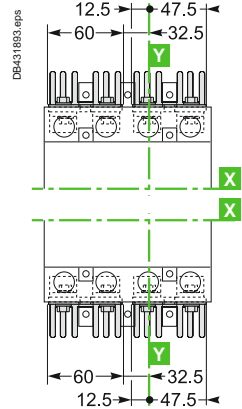
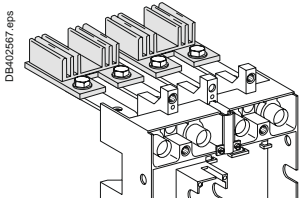

Connections mounted with heat sink directed inwards

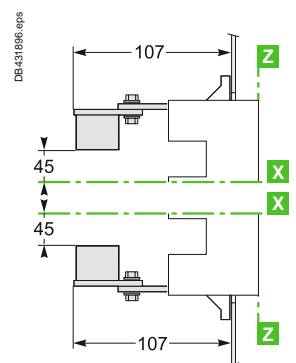
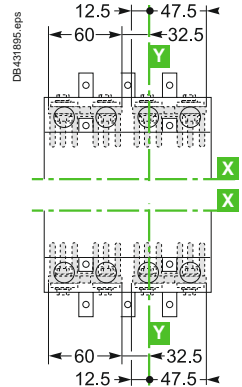
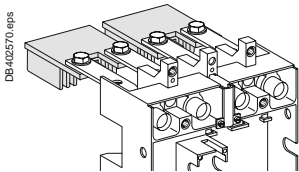

Dimensions and connection

Compact (withdraw. version) 3P-4P Parallel and series connection of poles Compact NSX400 to NSX630 DC

3P withdrawable version

Connections mounted with heat sink directed outwards

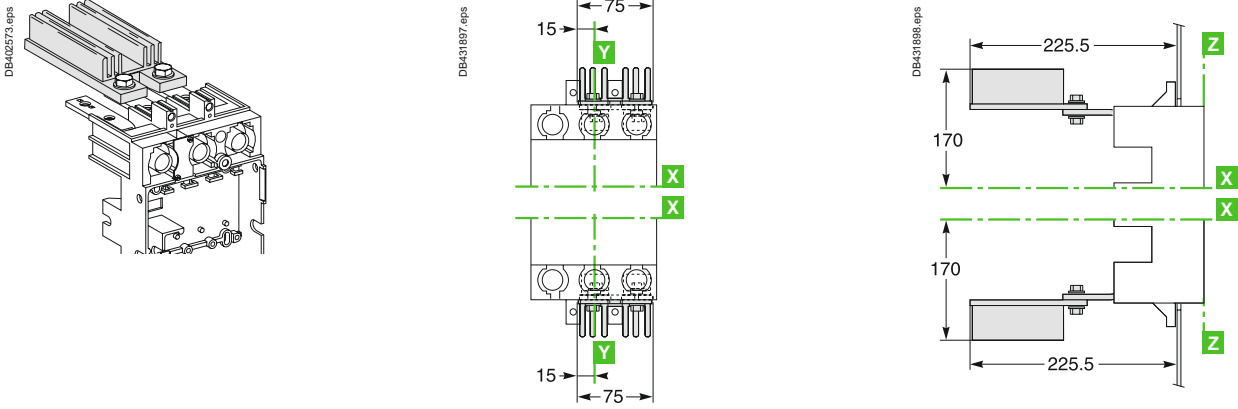

Connections mounted with heat sink directed inwards

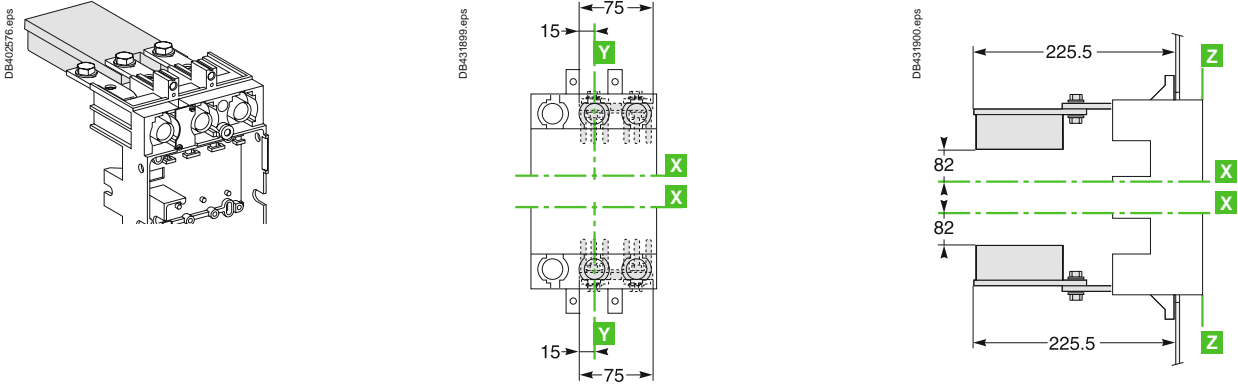

4P withdrawable version

Connections mounted with heat sink directed outwards

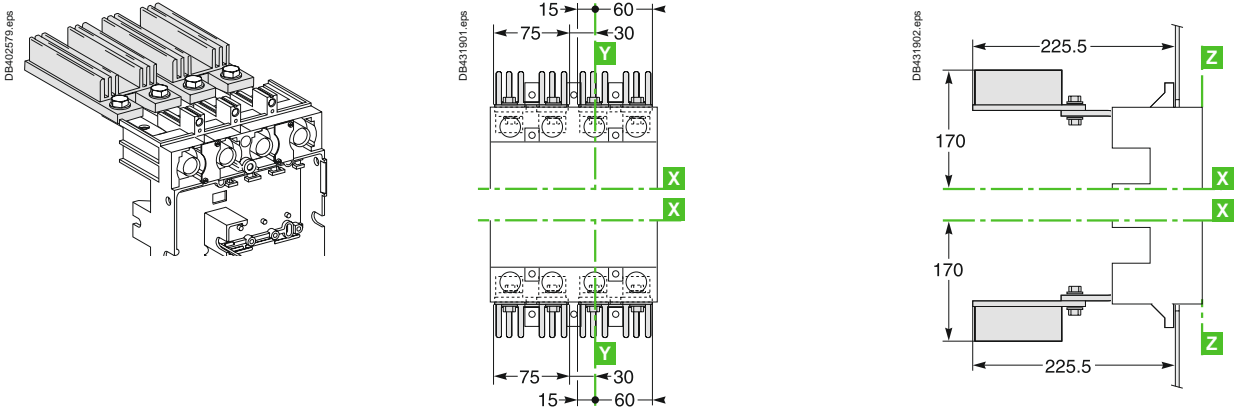

Connections mounted with heat sink directed inwards

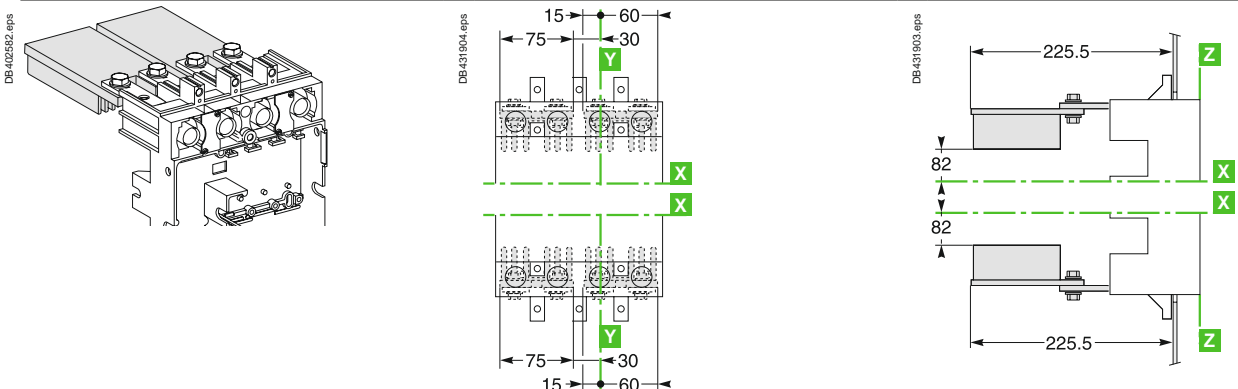

Compact (fixed version)

4P connection of poles, dimensions and mounting

Compact NSX100 to NSX630 DC PV

4P fixed version (Compact NSX100-200 DC PV)

With series connections

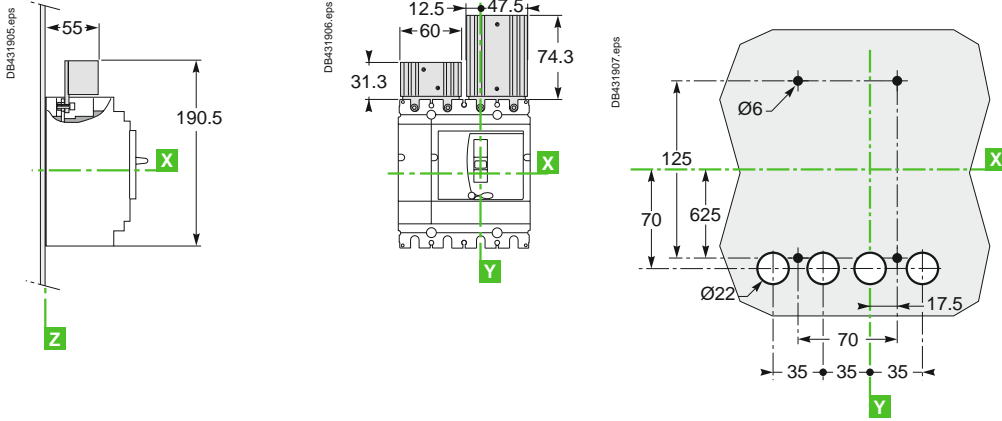

4P fixed version (Compact NSX250-630 DC PV)

With series connections

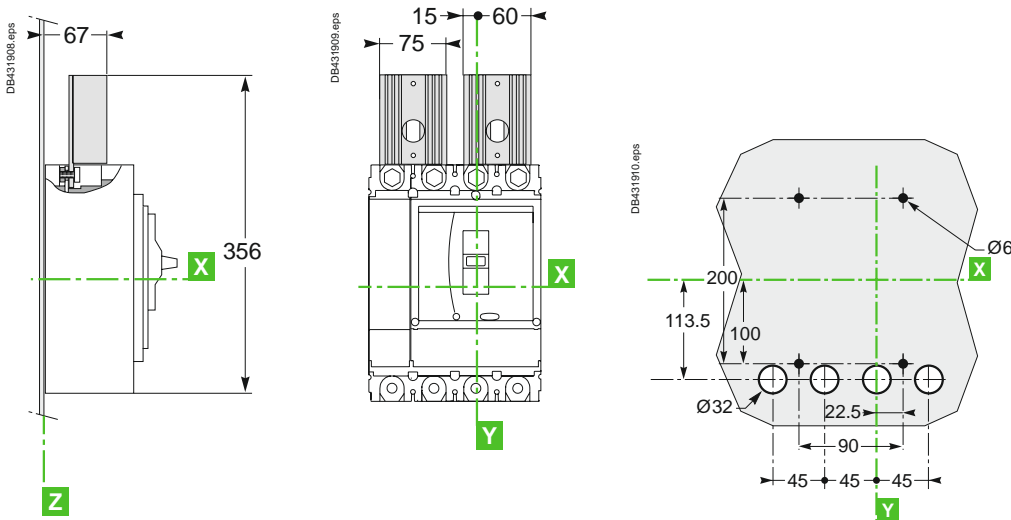

Dimensions

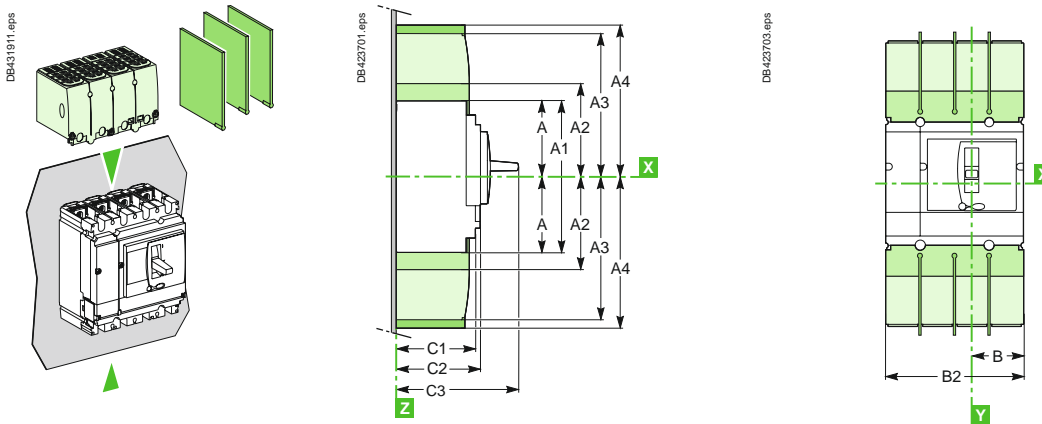

Interphase barriers.
 Long terminal shields.

Long terminal shields (also available for NSX400/630 DC spreaders with 52.5 mm pitch: B2 = 210 mm).

Type	A	A1	A2	A3	A4	B	B2	C1	C2	C3
NSX100/160/200 DC PV	80.5	161	94	145	178.5	52.5	140	81	86	126
NSX250/630 DC PV	127.5	255	142.5	240	237	70	185	95.5	110	168

Dimensions and connection

Compact (fixed version)

4P connection of poles, dimensions

Compact NSX630b to 1600 DC PV

Electrical control

Front connection

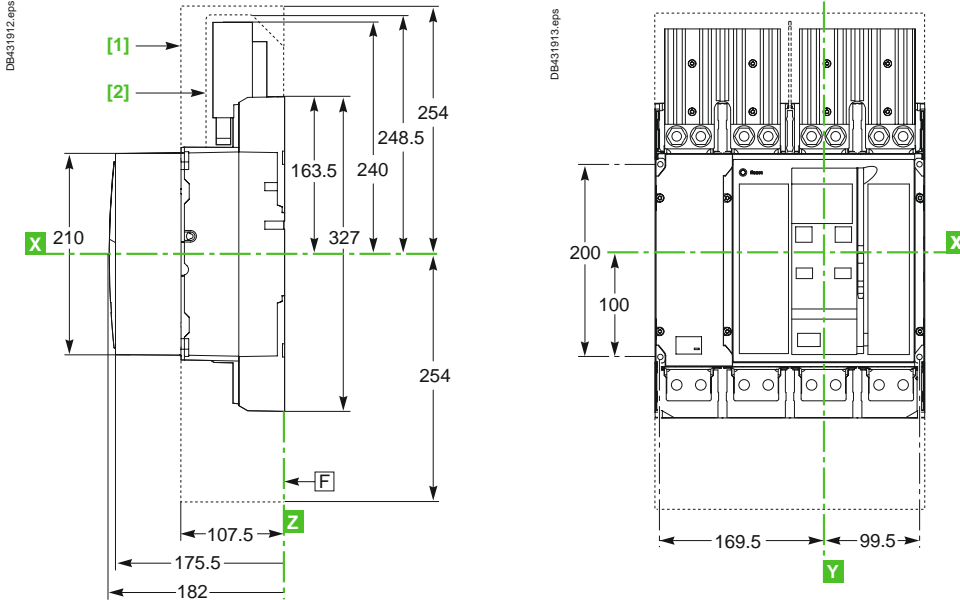

[1] With terminal shield.
[2] With phase separator.

Rear connection

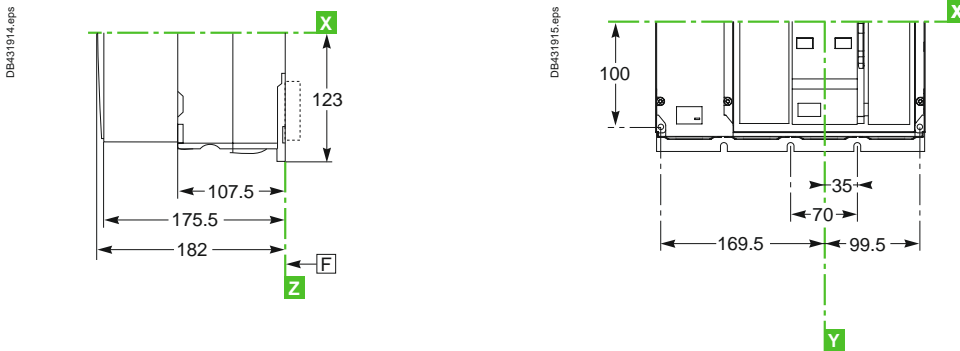

Front-panel cutouts

Door cutout A

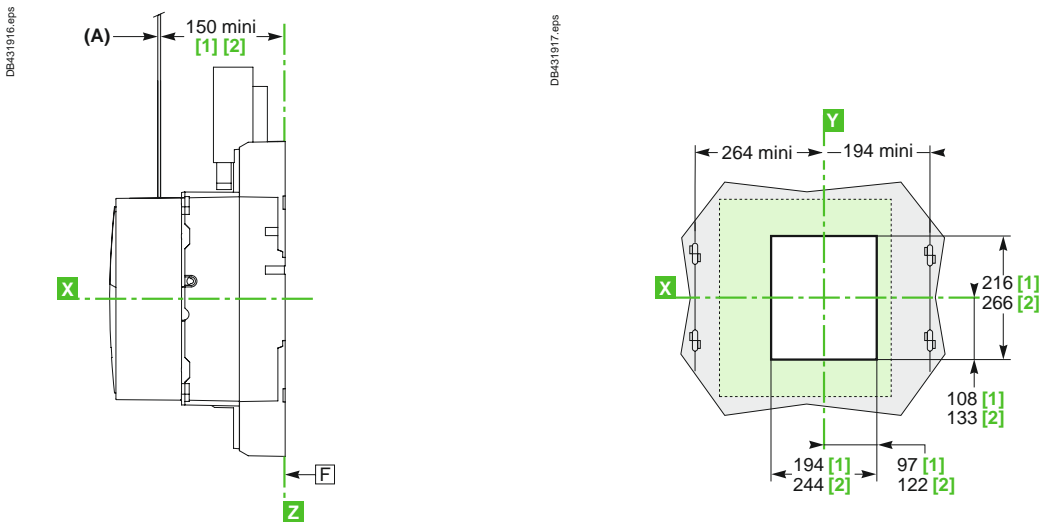

F: Datum.
[1] Without escutcheon.
[2] With escutcheon.

Compact (fixed version) 4P front connection of poles, mounting Compact NSX630b to 1600 DC PV

On backplate

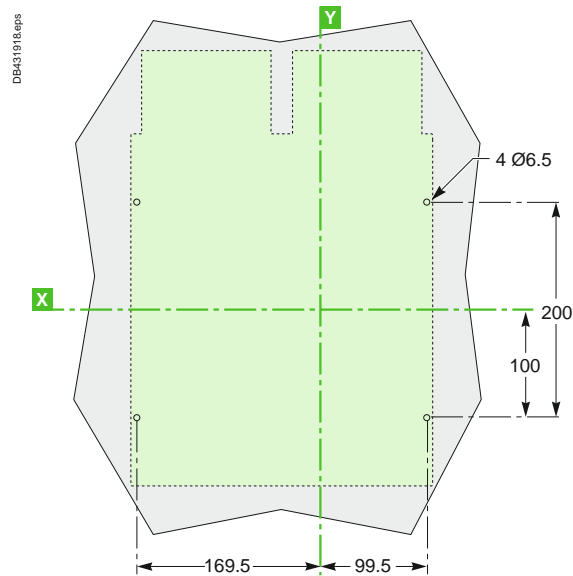

On rails

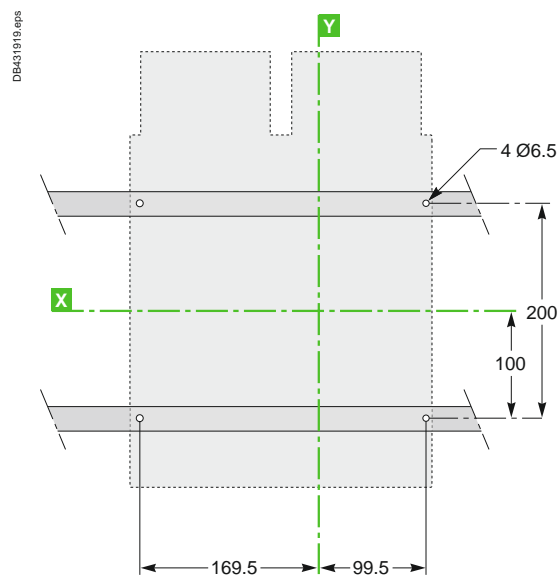

Note: mounting parameters for electrically operated devices are identical to those for manually operated devices.
X and Y are the symmetry planes for a 4-pole device.
Z is the back plane of the device.

Compact (fixed version)

4P rear connection of poles, mounting

Compact NSX630b to 1600 DC PV

On backplate

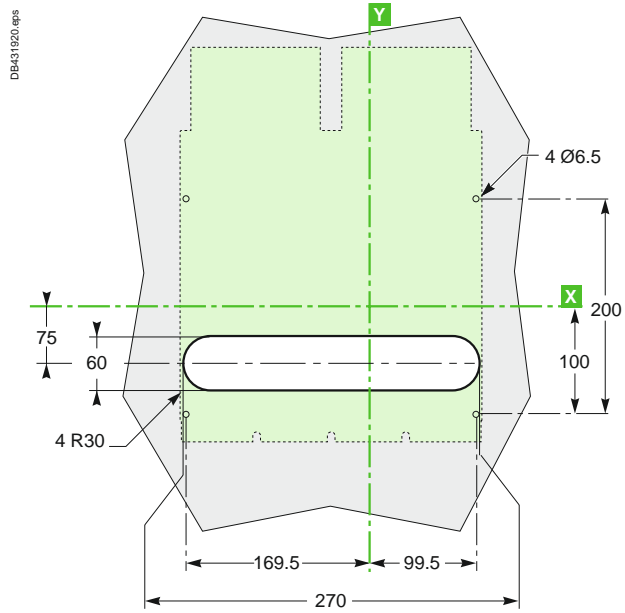

On rails

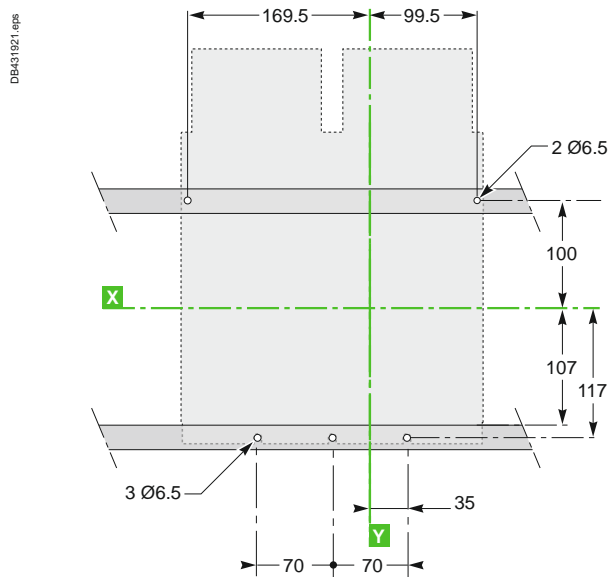

Note: mounting parameters for electrically operated devices are identical to those for manually operated devices.

X and Y are the symmetry planes for a 4-pole device.

Z is the back plane of the device.

Masterpact (fixed device)

NW10 to 40 DC version C/D (3P),
version E (4P) NW10 to 40 DC PV version D (3P)

Device

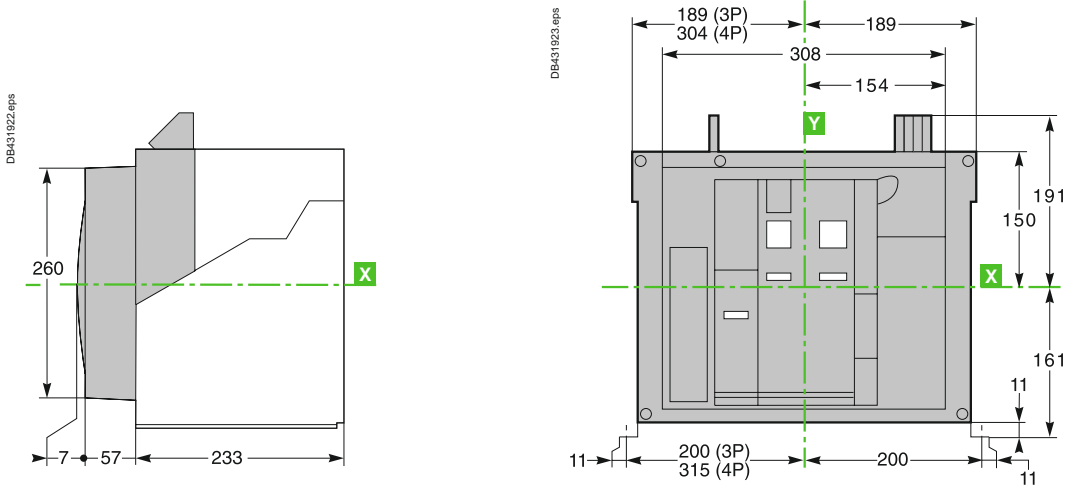

Mounting on base plate or rails

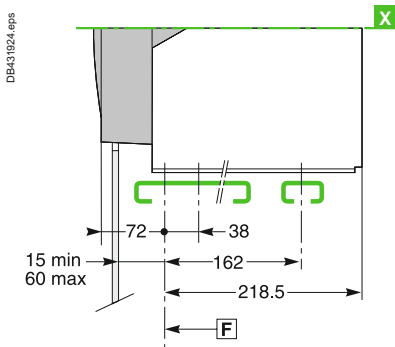

Mounting detail

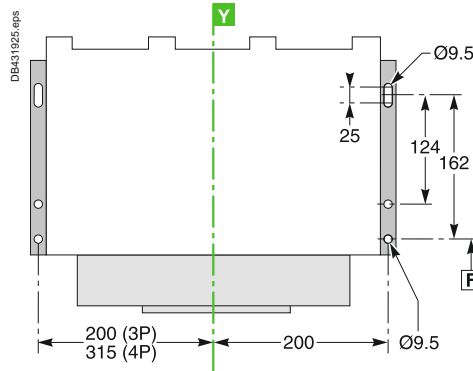

Safety clearances

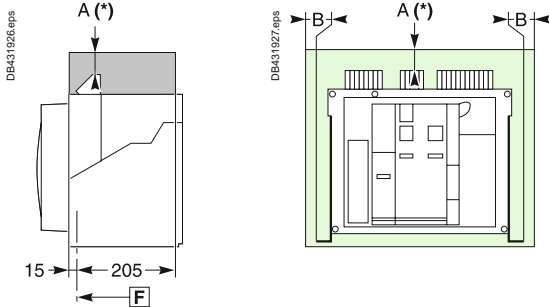

Door cutout

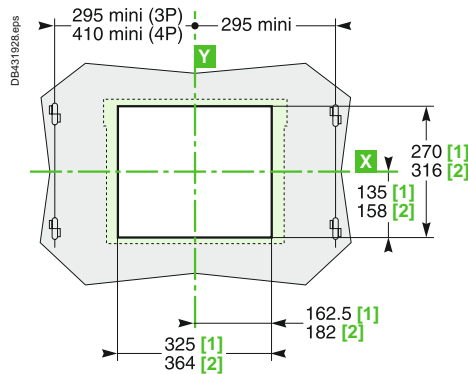

	Insulated parts	Metal parts	Energised parts
A	0	0	100
B	0	0	60

Note:
 [1] Without escutcheon.
 [2] With escutcheon.
 X and Y are the symmetry planes for a 3-pole device.
 A[*] An overhead clearance of 110 mm is required to remove the arc chutes.
 An overhead clearance of 20 mm is required to remove the terminal block.

F: Datum.





Masterpack (fixed device) NW10 to 40 DC-Version C

Connections

Horizontal rear connection (NW10–NW20 DC)

Detail

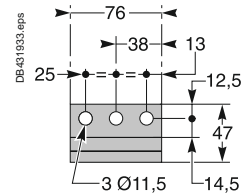
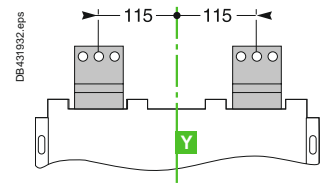
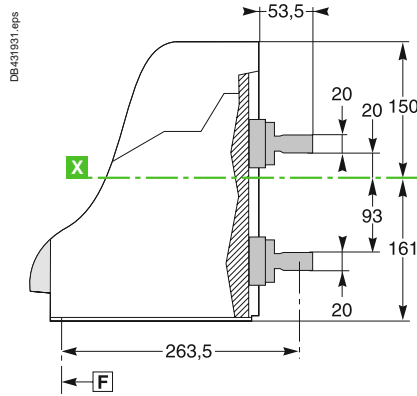
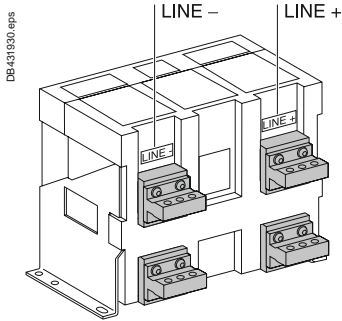

Vertical rear connection (NW10–NW20 DC)

Detail

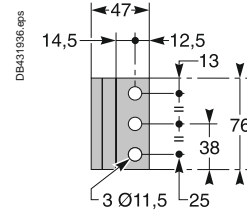
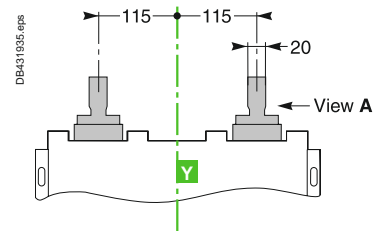
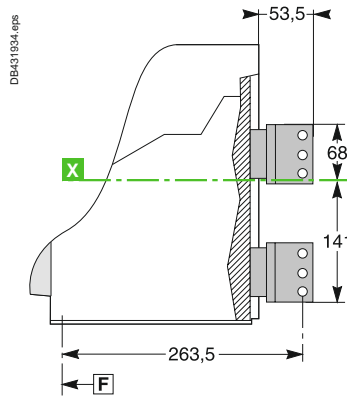
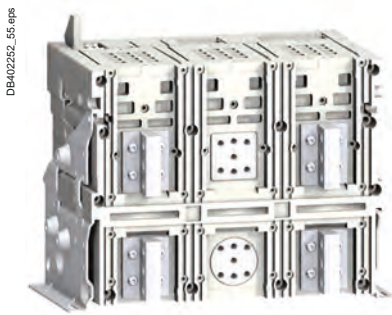

View A detail.

Vertical rear connection (NW40 DC)

Detail

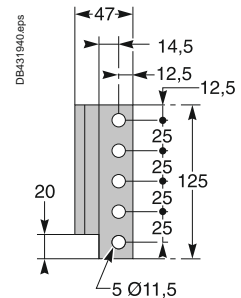
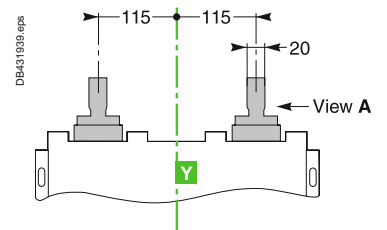
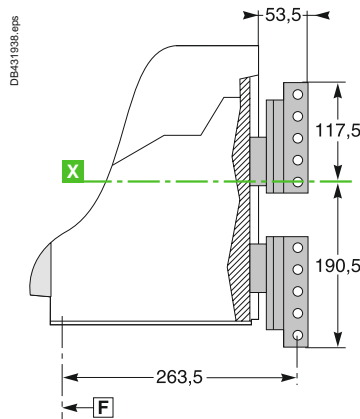
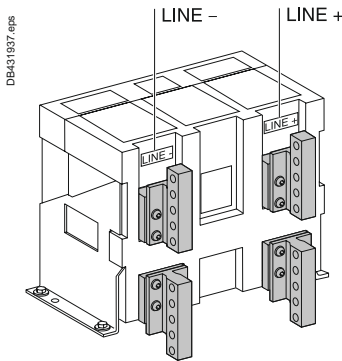

View A detail.

Note: Recommended connection screws: M10 class 8.8.
Tightening torque: 50 Nm with contact washer.

C

Masterpact (fixed device) NW10 to 40 DC-DC PV-Version D

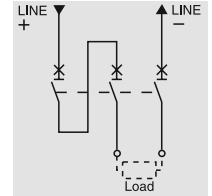

Connections

Horizontal rear connection (NW10–NW20 DC-DC PV)

Detail

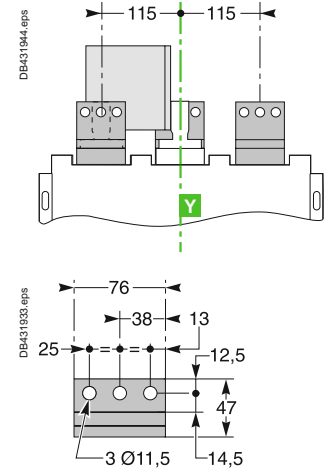
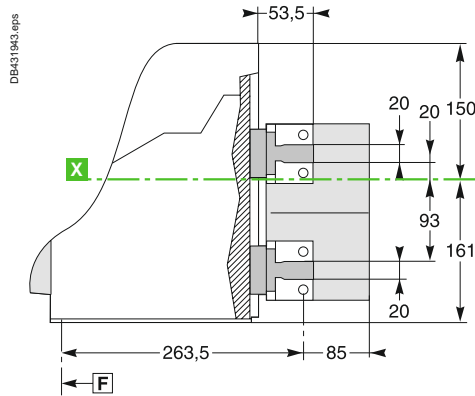
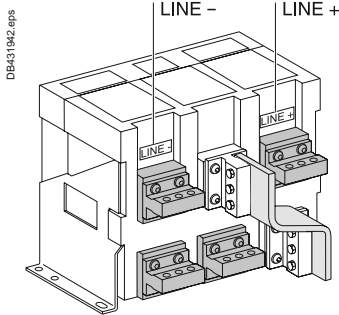

Vertical rear connection (NW10–NW20 DC-DC PV)

Detail

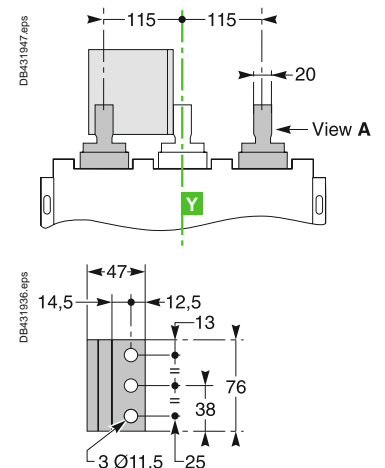
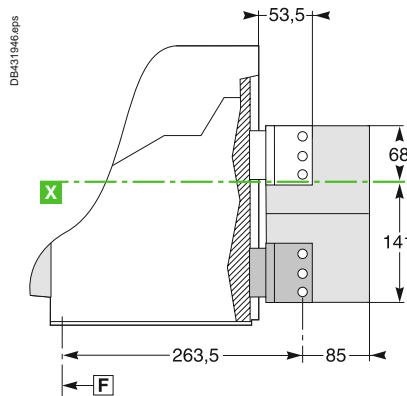
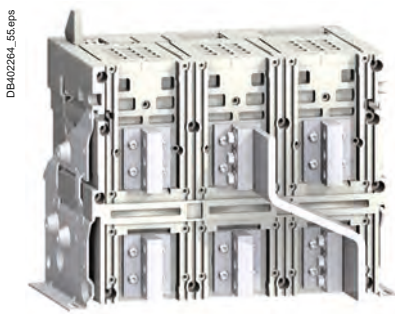

View A detail.

Vertical rear connection (NW40 DC-DC PV)

Detail

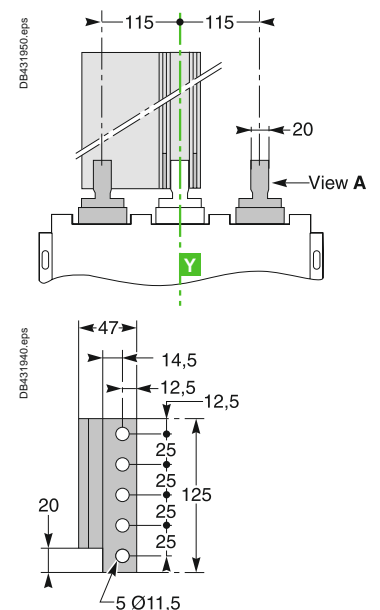
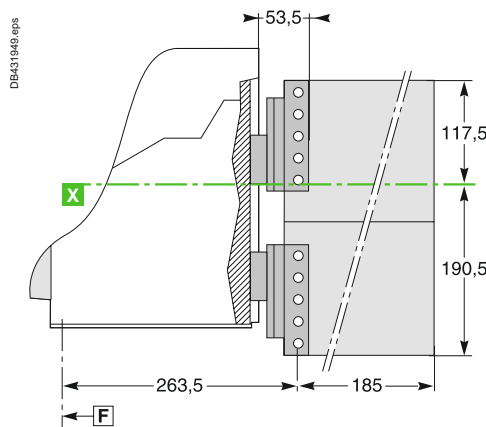
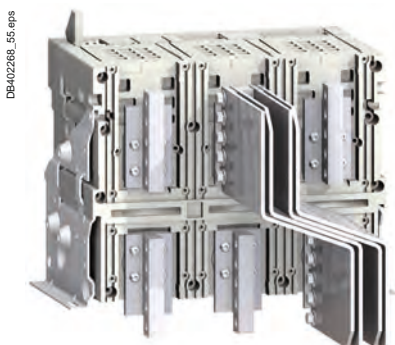

View A detail.

Note: Recommended connection screws: M10 class 8.8.
Tightening torque: 50 Nm with contact washer.



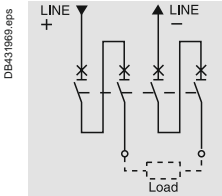

Masterpact (fixed device)

NW10 to 40 DC-Version E

Connections

Horizontal rear connection (NW10–NW20 DC)

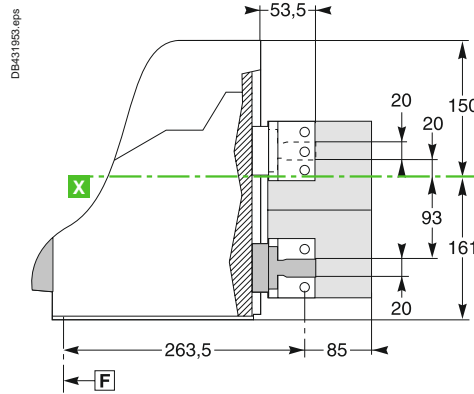
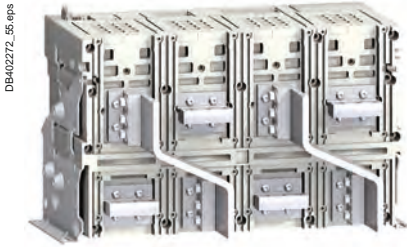

Detail

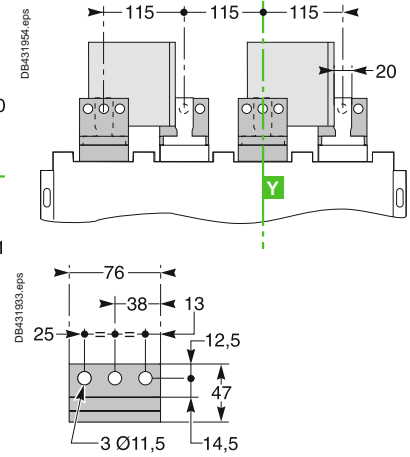

Vertical rear connection (NW10–NW20 DC)

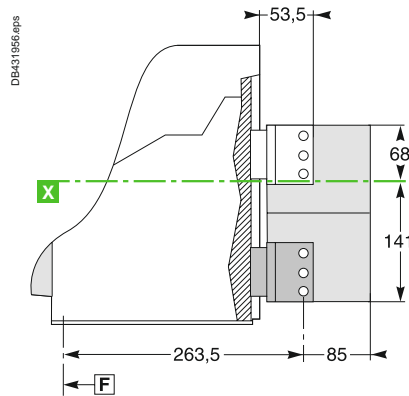

Detail

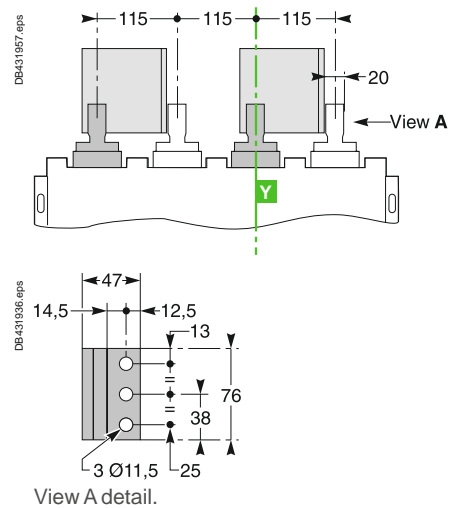

Vertical rear connection (NW40 DC)

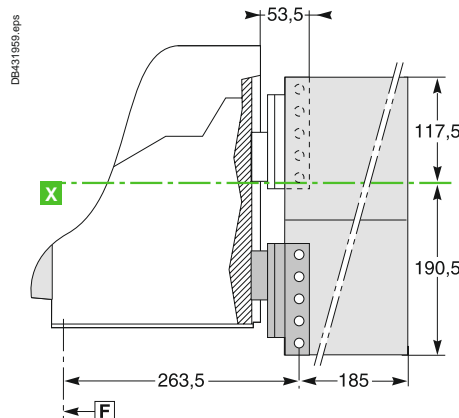

Detail

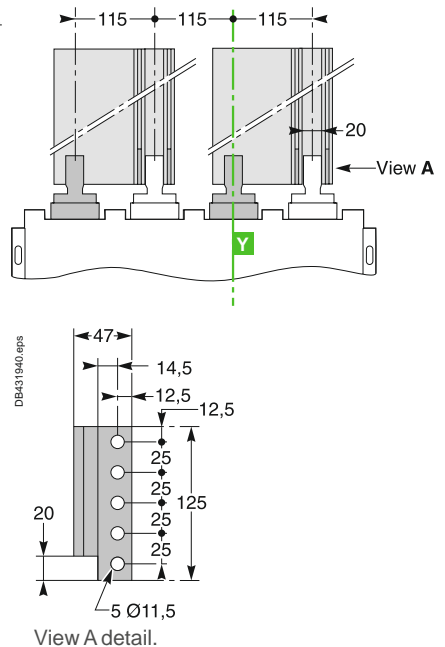

Note: Recommended connection screws: M10 class 8.8.
Tightening torque: 50 Nm with contact washer.

Masterpact (drawout device)

NW10 to 40 DC version C/D (3P) version E (4P)
 NW10 to 40 DC PV version D (3P)

Device

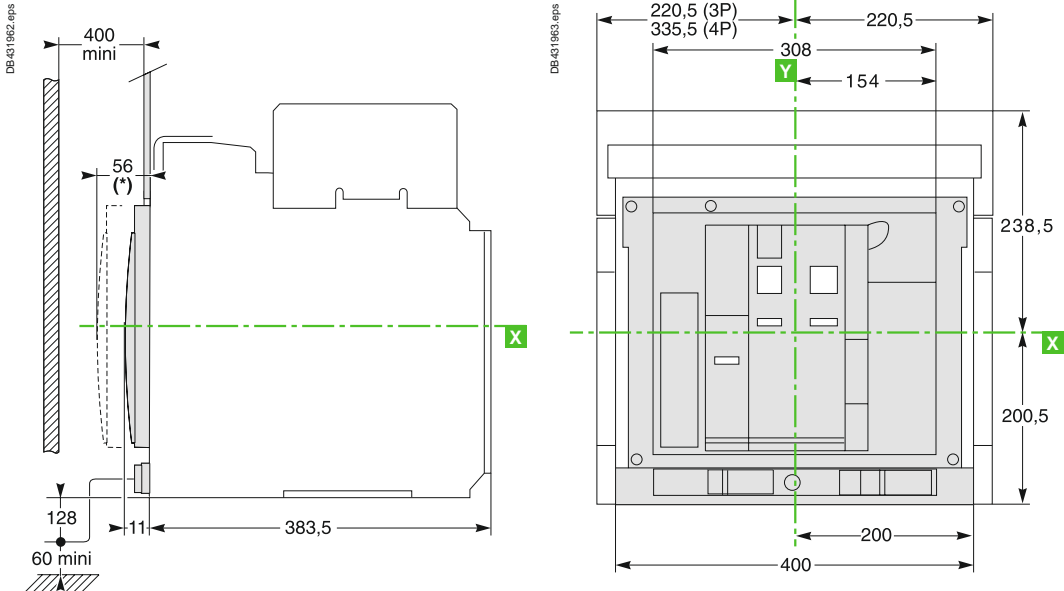

[*] Drawout position.

Mounting on base plate or rails

Mounting detail

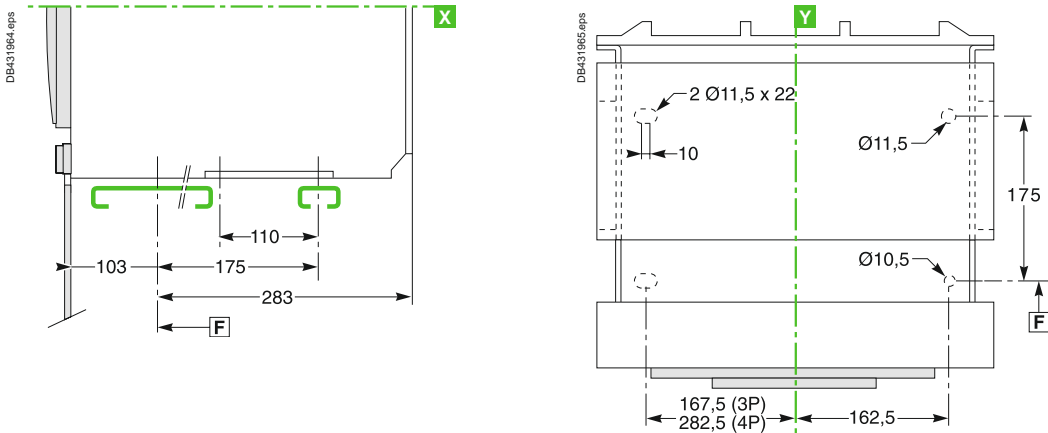

Safety clearances

Door cutout

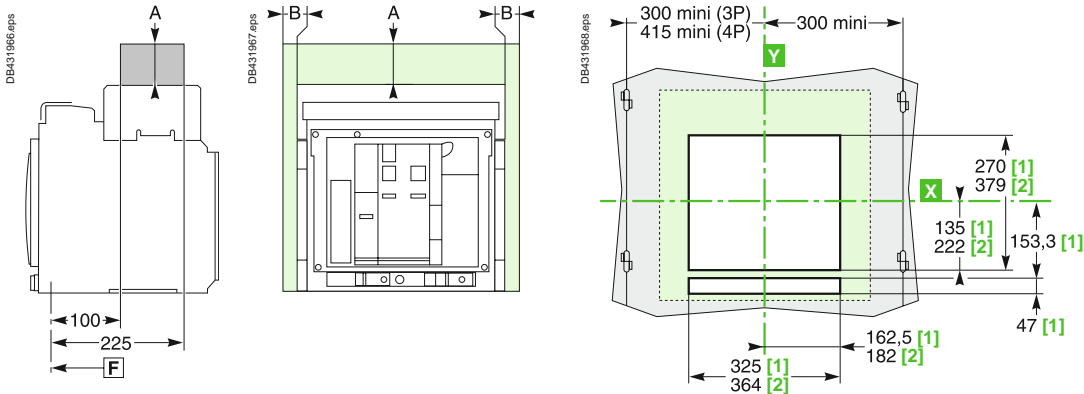

	Insulated parts	Metal parts	Energised parts
A	0	0	0
B	0	0	60

F Datum.

Note:

- [1] Without escutcheon
- [2] With escutcheon

X and Y are the symmetry planes for a 3-pole device.



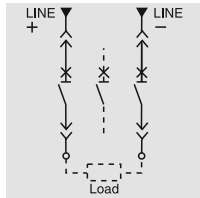

Masterpact (drawout device) NW10 to 40 DC-Version C

Connections

Horizontal rear connection (NW10–NW20 DC)

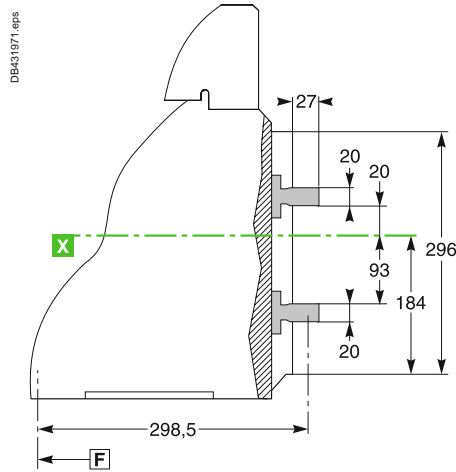

Detail

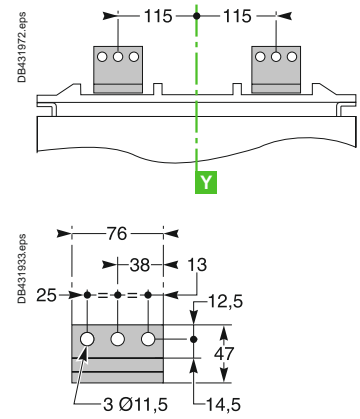

Vertical rear connection (NW10–NW20 DC)

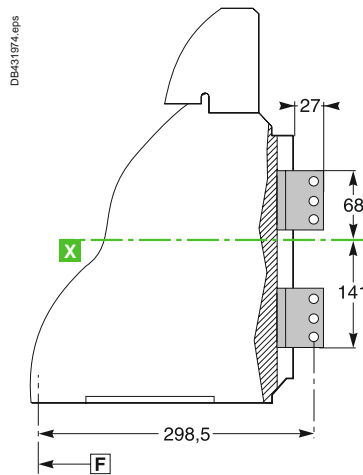

Detail

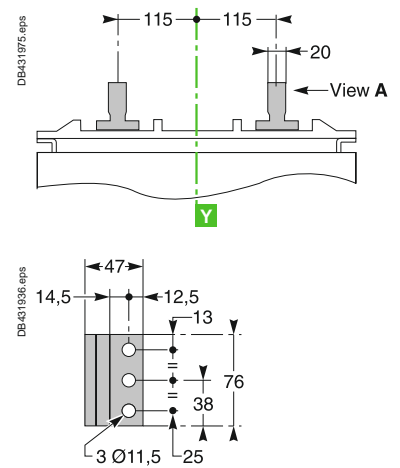

View A detail.

Detail

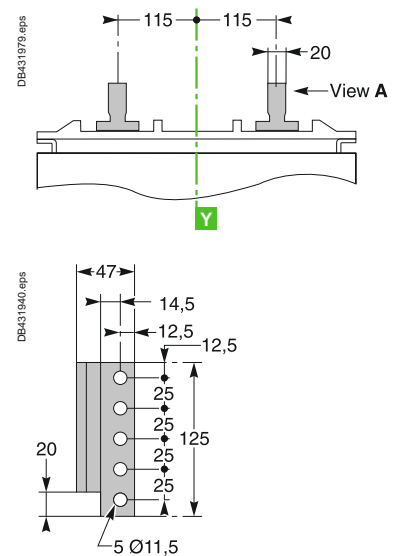

View A detail.

Vertical rear connection (NW40 DC)

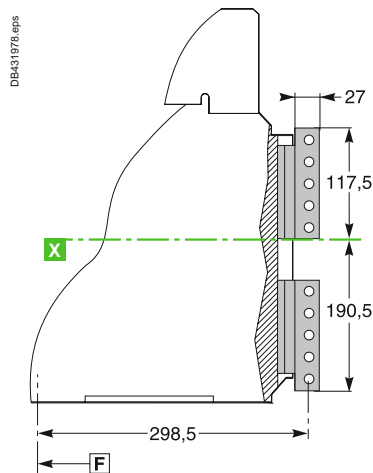
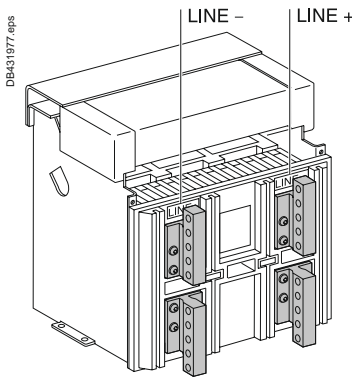

Note: Recommended connection screws: M10 class 8.8.
Tightening torque: 50 Nm with contact washer.

Masterpact (drawout device) NW10 to 40 DC-DC PV-Version D

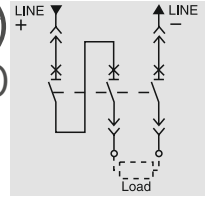

Connections

Horizontal rear connection (NW10–NW20 DC-DC PV)

Detail

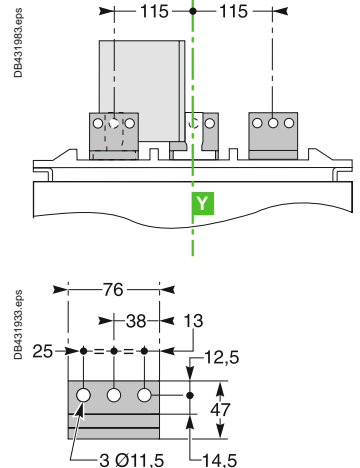
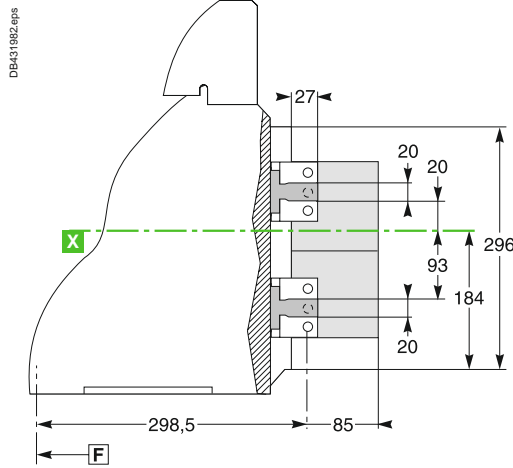
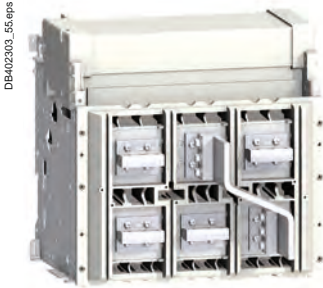

Vertical rear connection (NW10–NW20 DC-DC PV)

Detail

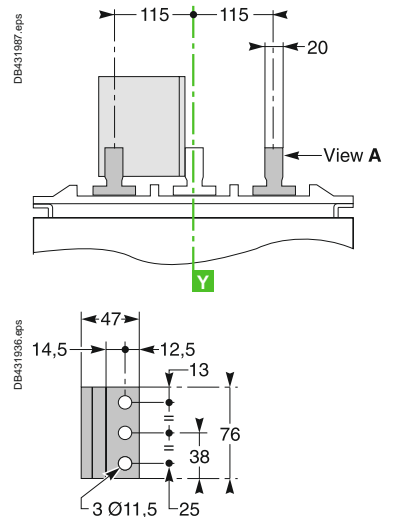
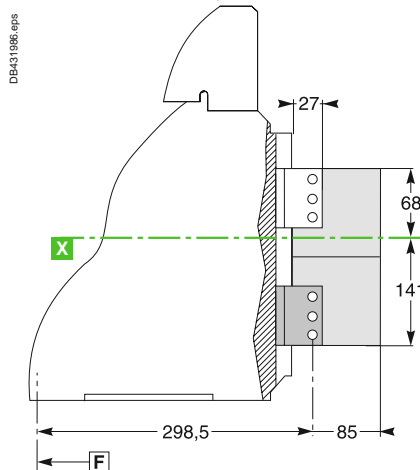
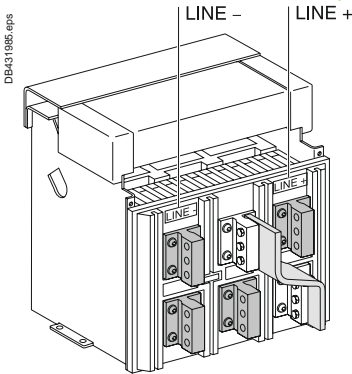

Vertical rear connection (NW40 DC-DC PV)

Detail

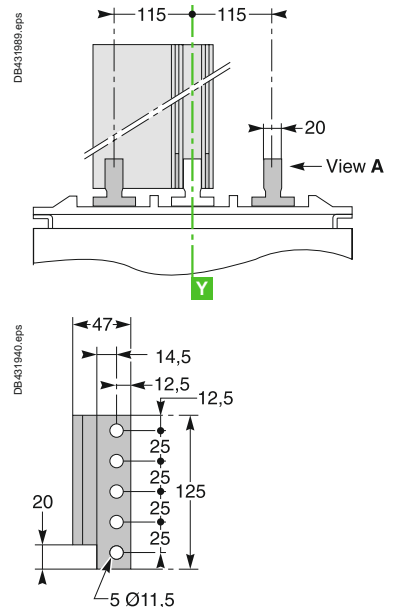
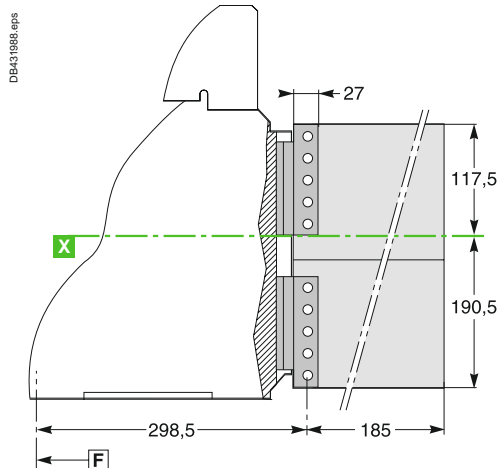
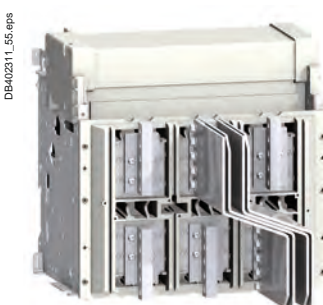

Note: Recommended connection screws: M10 class 8.8.
Tightening torque: 50 Nm with contact washer.



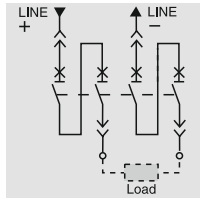

Masterpact (drawout device) NW10 to 40 DC-Version E

Connections

Horizontal rear connection (NW10–NW20 DC)

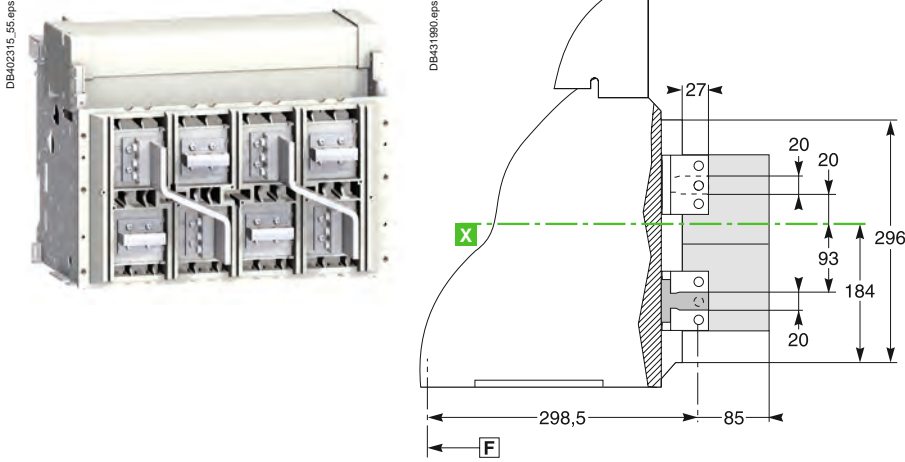

Detail

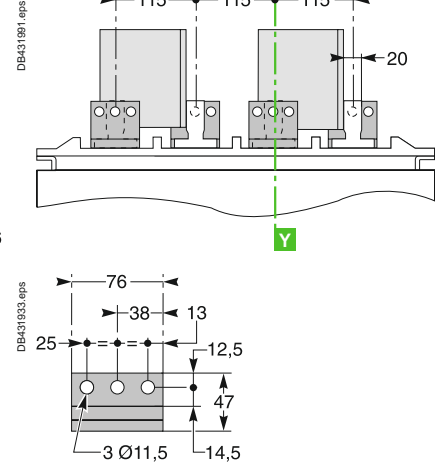

Vertical rear connection (NW10–NW20 DC)

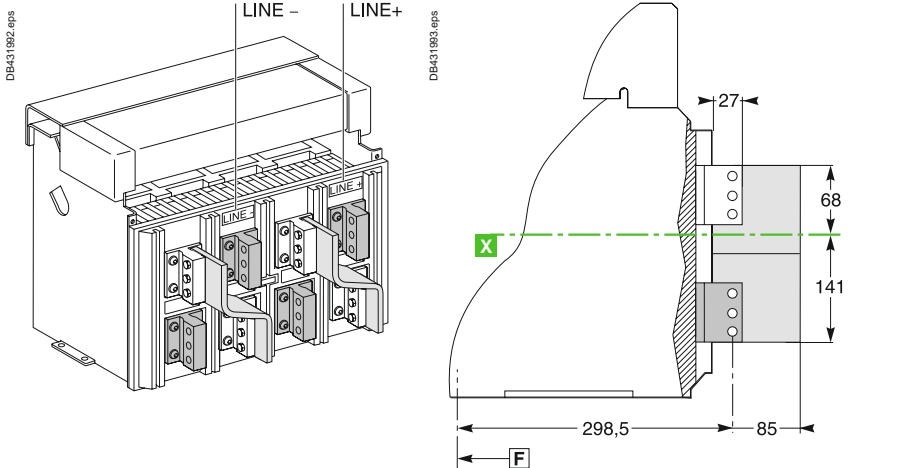

Detail

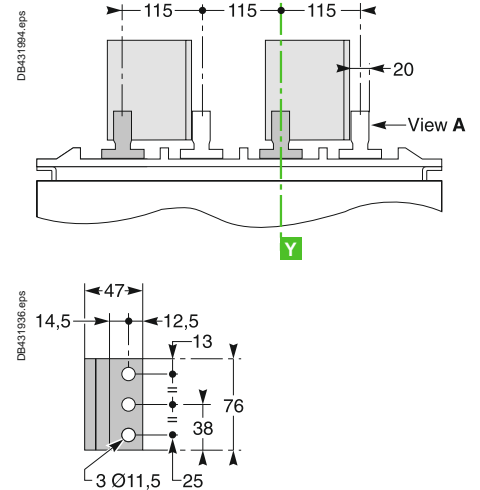

Vertical rear connection (NW40 DC)

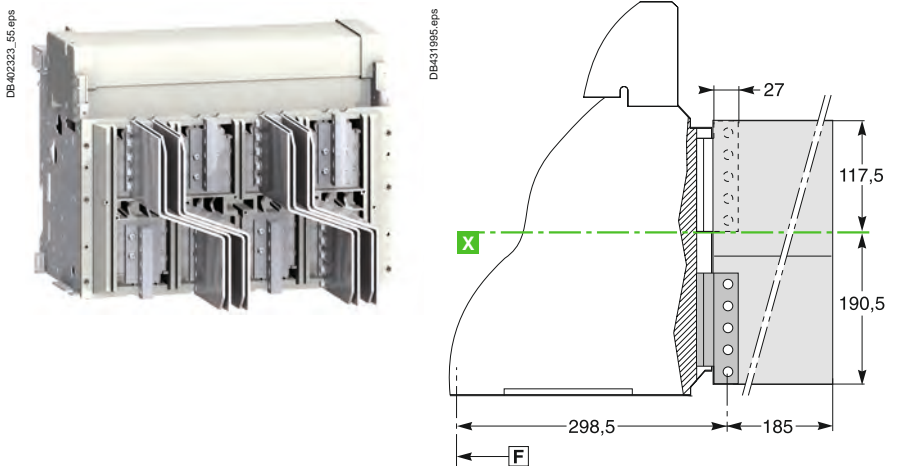

Detail

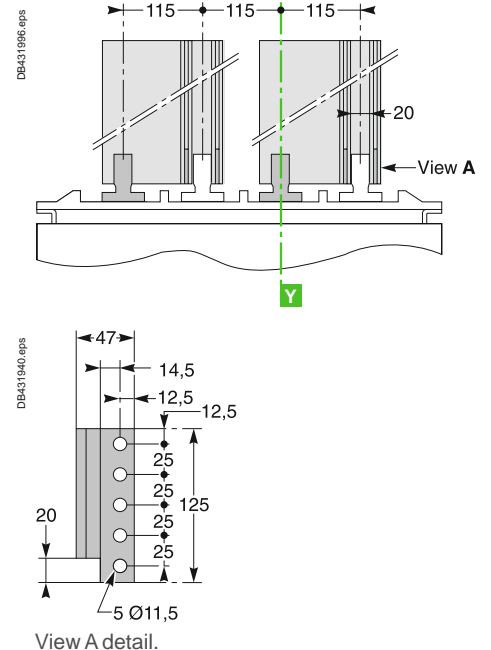

Note: Recommended connection screws: M10 class 8.8.
Tightening torque: 50 Nm with contact washer.



Rear panel cutout (drawout device)

NW10 to NW40 DC-DC PV

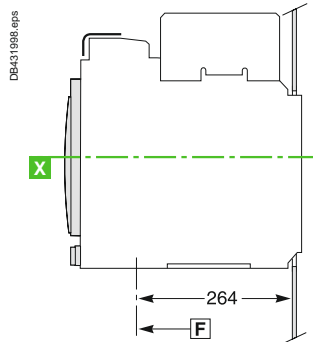
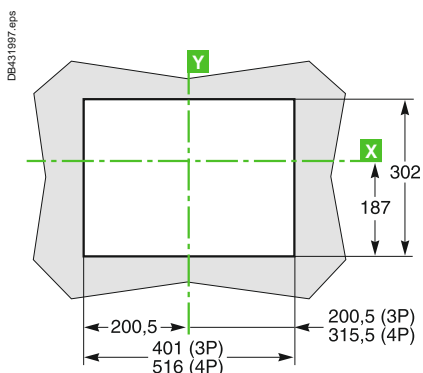

FDatum.

Escutcheon

Fixed device

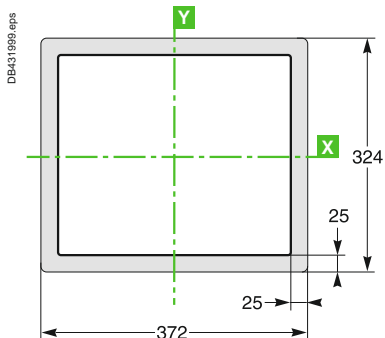

Drawout device

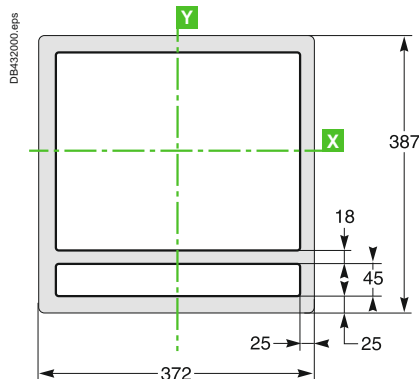

Connection of auxiliary wiring to terminal block

DB431955.eps

- S : 0,6 mm²**
- S : 2,5 mm²**

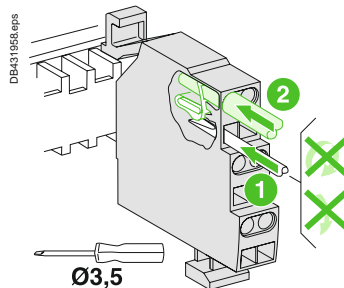
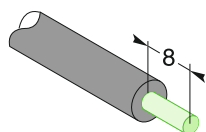

One conductor only per connection point.

Masterpact NW10 to 40 DC-DC PV Accessories

Delay unit for MN release

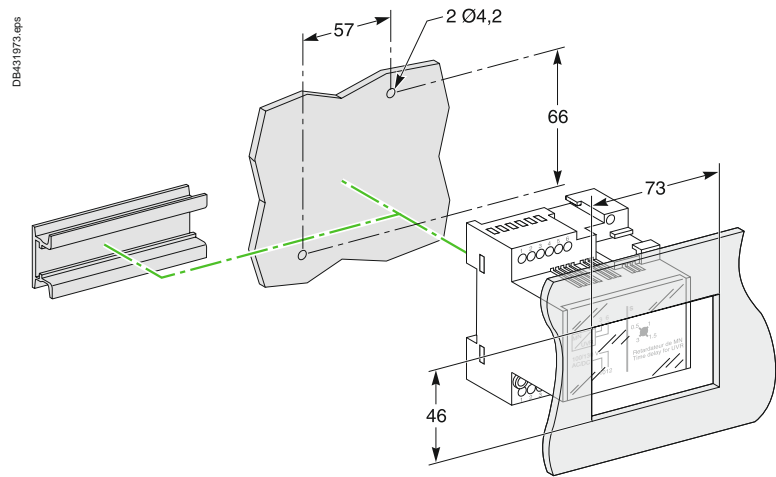
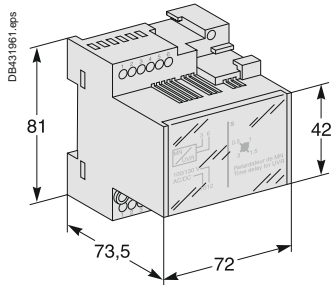

C

“Chassis” communication module

Modbus

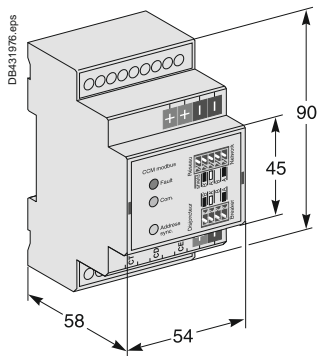

Dimensions and mounting

External modules for Compact and Masterpact

I/O (Input/Output) application module

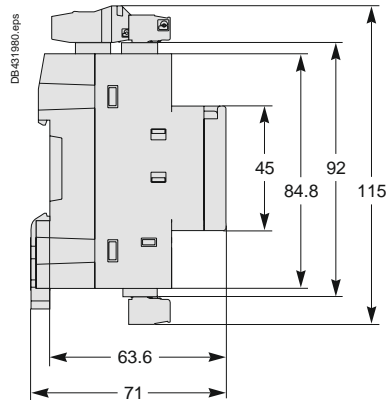
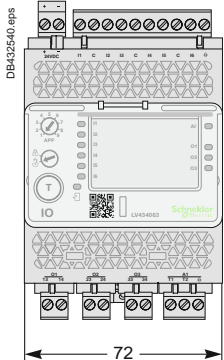

IFM-Modbus-SL interface

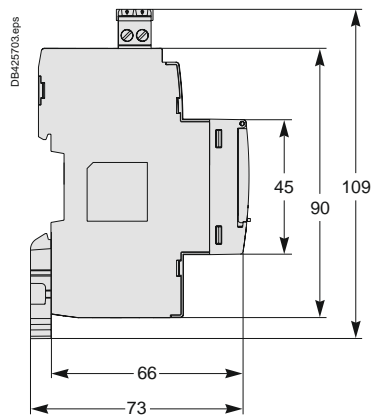
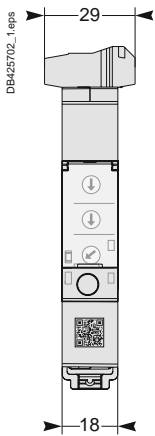

IFE-Ethernet interface

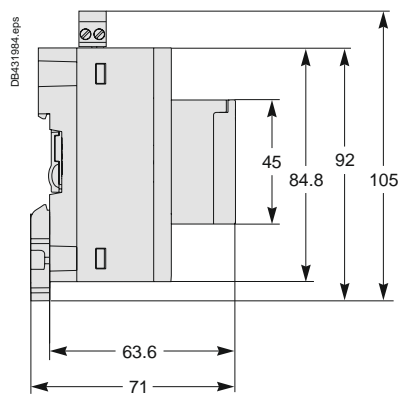
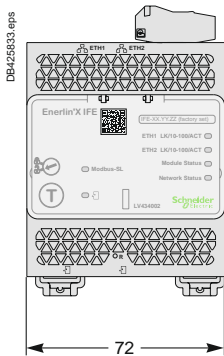

Com'X 210

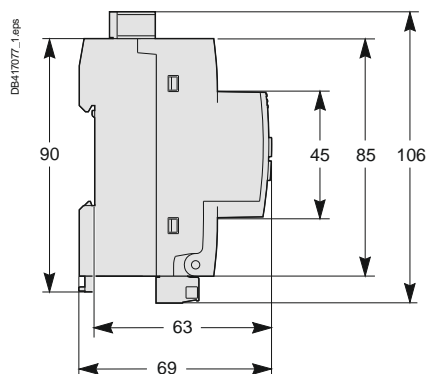
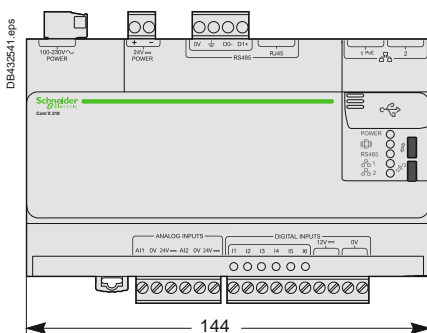

FDM128 switchboard display

Dimensions

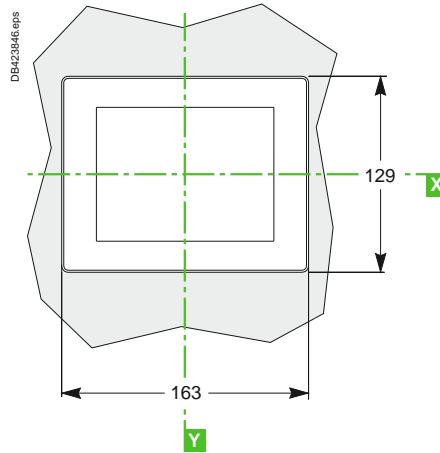
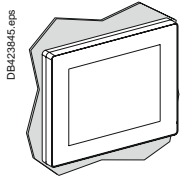

Mounting

On panel

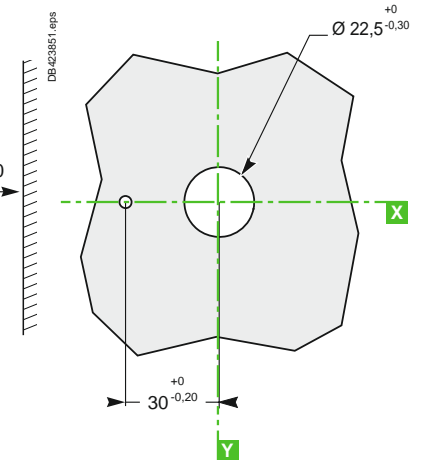
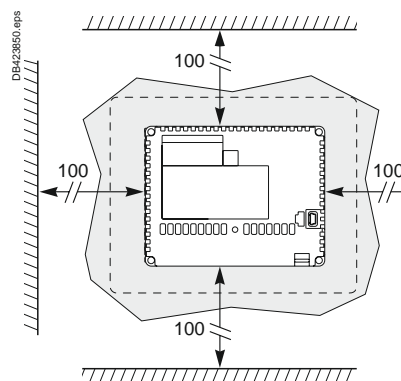
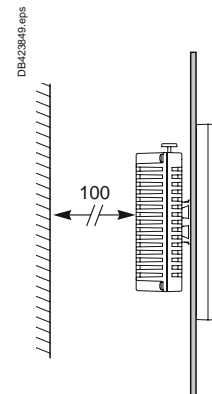
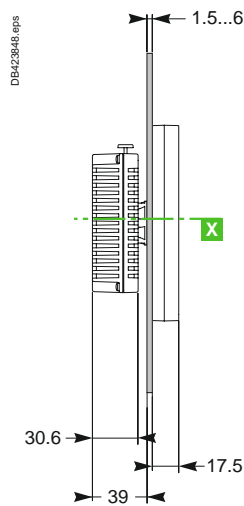
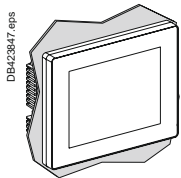



Electrical diagrams

Compact NSX100 to 1200 DC	
Fixed circuit breakers	D-2
Compact NSX100 to 630 DC	
Plug-in / withdrawable circuit breakers	D-4
Compact NSX100 to 630 DC - DC PV	
Motor mechanism	D-6
Communication	D-8
Compact NSX630b to NSX1600 DC PV	
Fixed switch-disconnectors	D-10
Masterpact NW10 to NW40 DC - DC PV	
Fixed and drawout devices	D-12
Masterpact NW DC - DC PV	
Communication	D-14
Fixed, electrically operated Masterpact NW DC - DC PV	
Connection to the communication interface module	D-15
Withdrawable Masterpact NW DC - DC PV	
Connection to the I/O and communication interface module	D-16



Other chapters	
Presentation	2
Functions and characteristics	A-1
Installation recommendations	B-1
Dimensions and connection	C-1
Additional characteristics	E-1
Catalogue numbers and order form	F-1

Compact NSX100 to 1200 DC

Fixed circuit breakers

Remote operation

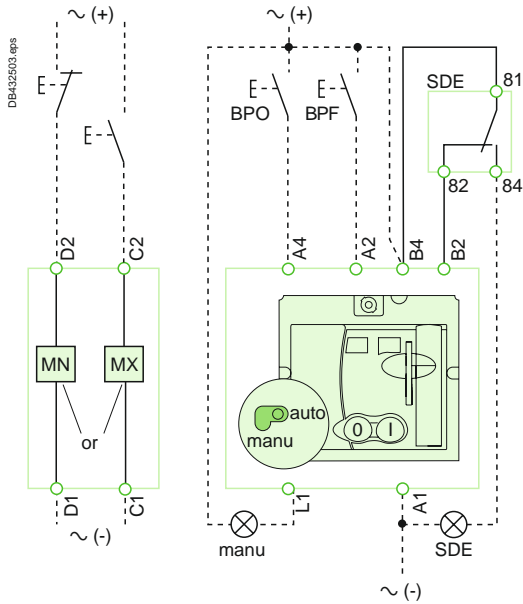

Motor mechanism (MT)

Remote operation

- MN:** undervoltage release
- or**
- MX:** shunt release

Motor mechanism (MT)

- A4:** opening order
- A2:** closing order
- B4, A1:** power supply to motor mechanism
- L1:** manual position (manu)
- B2:** SDE interlocking (mandatory for correct operation)
- BPO:** opening pushbutton
- BPF:** closing pushbutton

Communicating motor mechanism (MTc) ^[1]

- B4, A1:** motor mechanism power supply
- BSCM:** breaker status and control module

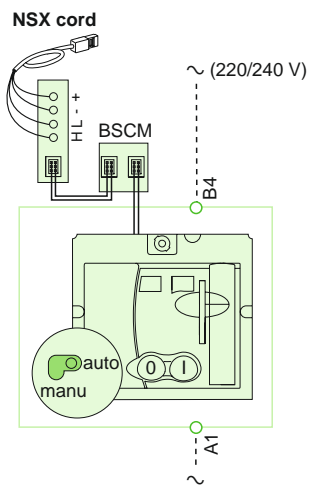

Communicating motor mechanism (MTc)

D

Compact NSX100 to 1200 DC Fixed circuit breakers

Indication contacts

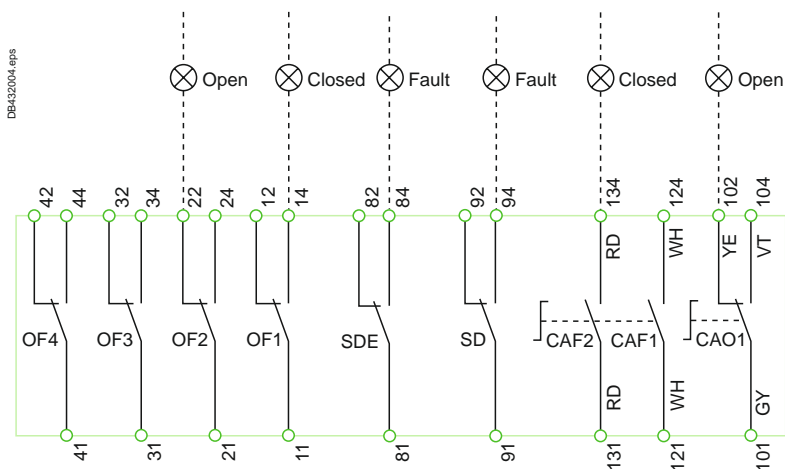

The diagram is shown with circuits de-energised, all devices open, connected and charged and relays in normal position.
Terminals shown in ○ must be connected by the customer.

- OF2 / OF1:** device ON/OFF indication contacts
- OF4 / OF3:** device ON/OFF indication contacts (NSX400/630)
- SDE:** fault-trip indication contact (short-circuit, overload, ground fault, earth leakage)
- SD:** trip-indication contact
- CAF2/CAF1:** early-make contact (rotary handle only)
- CAO1:** early-break contact (rotary handle only)

Colour code for auxiliary wiring

- | | |
|-------------------|-------------------|
| RD: red | VT: violet |
| WH: white | GY: grey |
| YE: yellow | OR: orange |
| BK: black | BL: blue |
| GN: green | |



Compact NSX100 to 630 DC

Plug-in / withdrawable circuit breakers

Remote operation

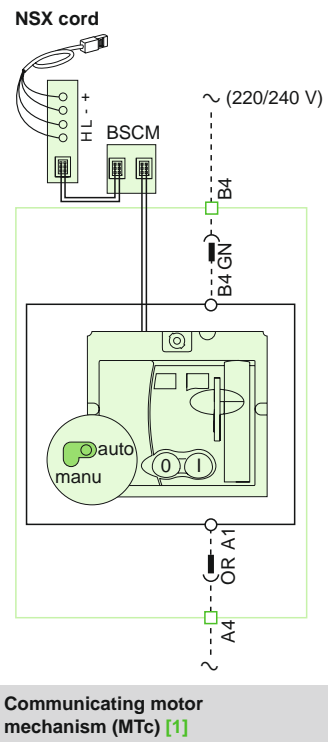
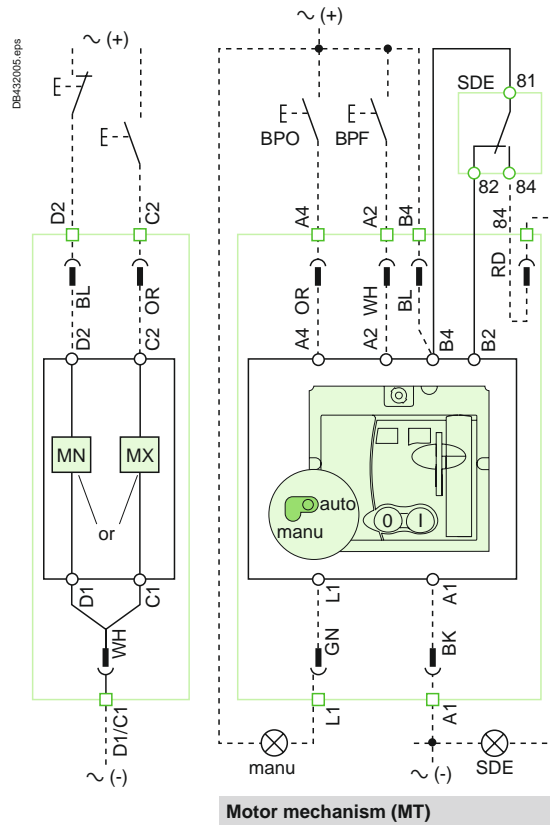

[1] NSX100-250 DC only.

Compact NSX100 to 630 DC Plug-in / withdrawable circuit breakers

Indication contacts

Carriage switches

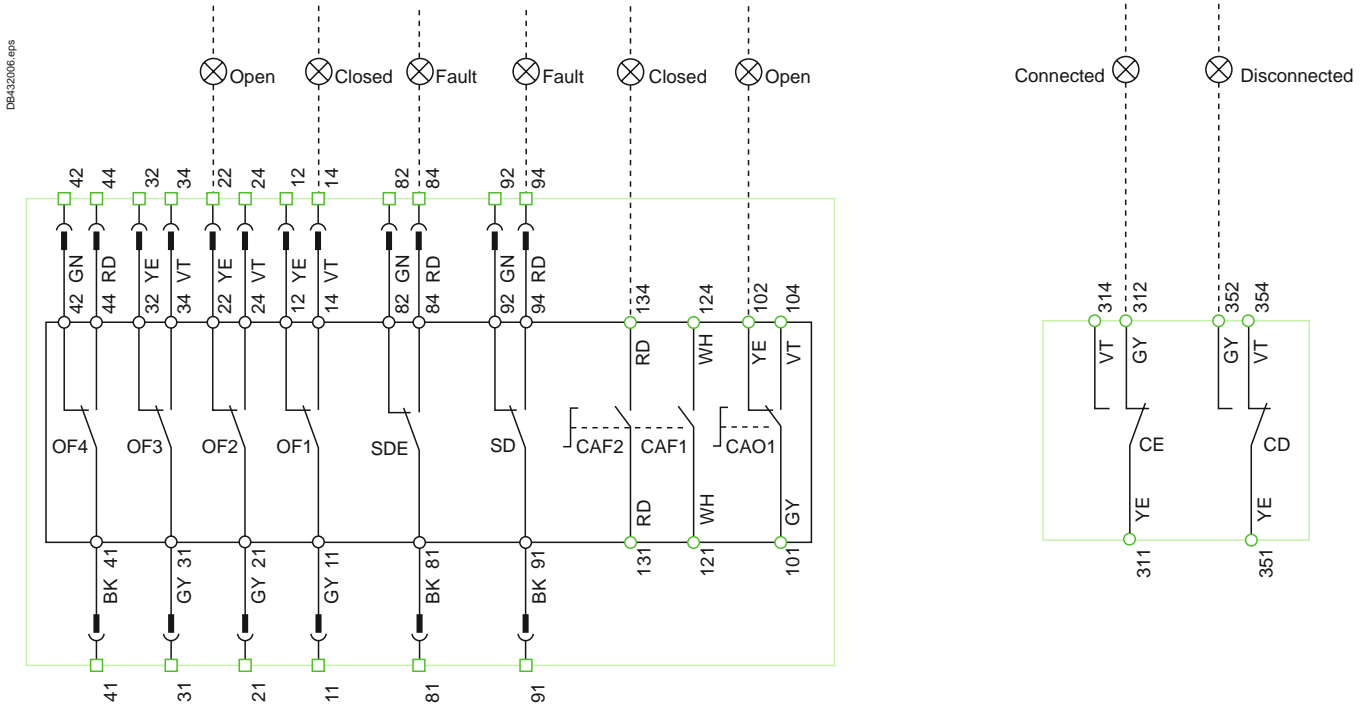

Remote operation

MN: undervoltage release

or

MX: shunt release

Motor mechanism (MT)

A4: opening order

A2: closing order

B4, A1: motor mechanism power supply

L1: manual position (manu)

B2: SDE interlocking (mandatory for automatic or remote recharging)

BPO: opening pushbutton

BPF: closing pushbutton

Communicating motor mechanism (MTc)

B4, A1: motor mechanism power supply

BSCM: breaker status and control module

Indication contacts

OF2 / OF1: device ON/OFF indication contacts

OF4 / OF3: device ON/OFF indication contacts (NSX400/630)

SDE: fault-trip indication contact (short-circuit, overload, ground fault, earth leakage)

SD: trip-indication contact

CAF2/CAF1: early-make contact (rotary handle only)

CAO1: early-break contact (rotary handle only)



Compact NSX100 to 630 DC - DC PV

Motor mechanism

Motor mechanism (MT) with automatic reset

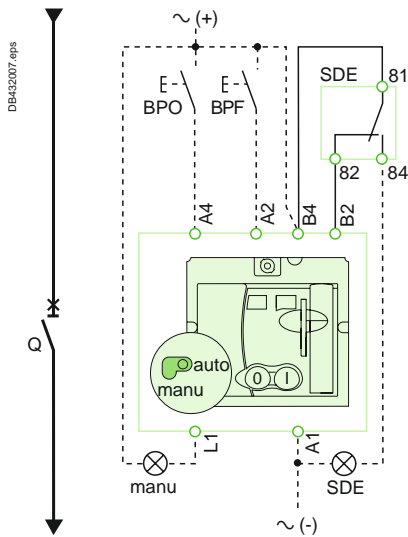

The diagram is shown with circuits de-energised, all devices open, connected and charged and relays in normal position.

After tripping initiated by the "Push to trip" button or by the undervoltage (MN) release or the shunt (MX) release, device reset can be automatic, remote or manual.

Following tripping due to an electrical fault (with an SDE contact), reset must be carried out manually.

Motor mechanism (MT) with remote reset

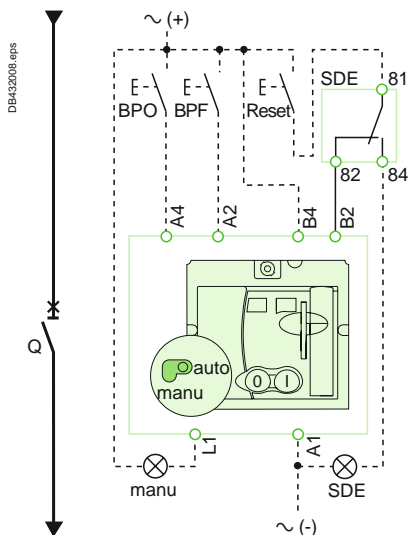

Motor mechanism (MT) with manual reset

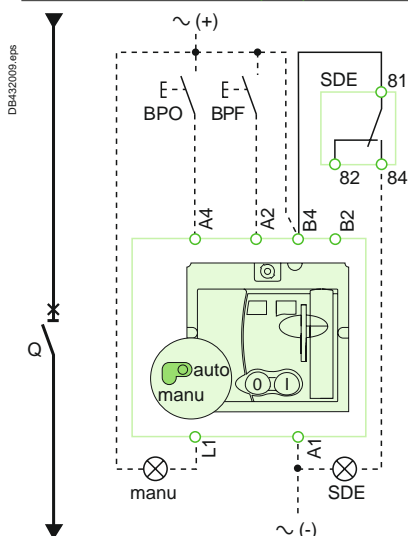

Symbols

- Q:** circuit breaker
- A4 :** opening order
- A2 :** closing order
- B4, A1:** motor mechanism power supply
- L1:** manual position (manu)
- B2:** SDE interlocking (mandatory for correct operation)
- BPO:** opening pushbutton
- BPF:** closing pushbutton
- SDE:** fault-trip indication contact (short-circuit, overload, ground fault, earth leakage)

Compact NSX100 to 630 DC - DC PV Motor mechanism

Communicating motor mechanism (MTc) [1]

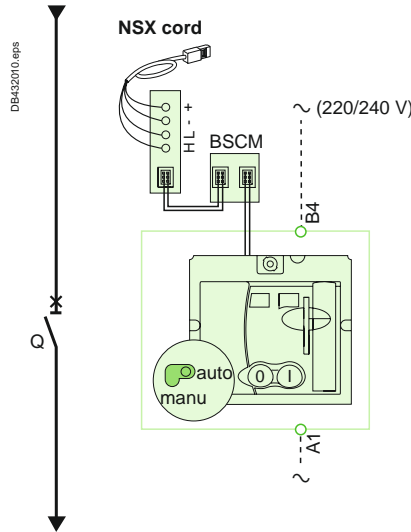

Schematic representation of the communicating motor mechanism (MT).

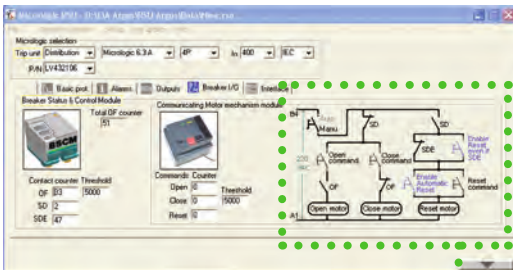

RSU utility setup screen for the communicating motor mechanism.

RSU screen for the communicating motor mechanism (MTc)

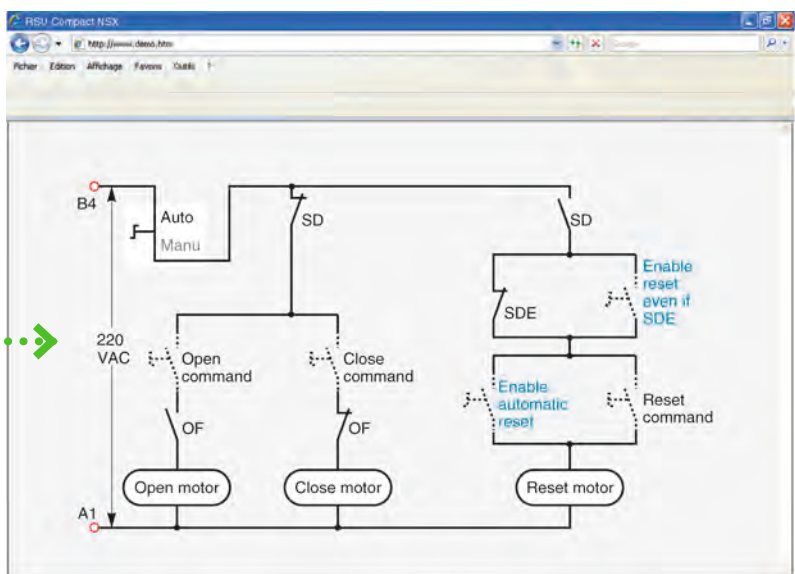

Single-line diagram of communicating motor mechanism

Opening, closing and reset orders are transmitted via the communication network. The "Enable automatic reset" and "Enable reset even if SDE" parameters must be set using the RSU software via the screen by clicking the blue text.

"Auto/manu" is a switch on the front of the motor mechanism.

Symbols

- Q:** circuit breaker
- B4, A1:** motor mechanism power supply
- BSCM:** breaker status and control module

Terminals shown in **O** must be connected by the customer.

[1] NSX100-250 only.



Compact NSX100 to 630 DC - DC PV Communication

Connection of circuit breakers to the Modbus communication network

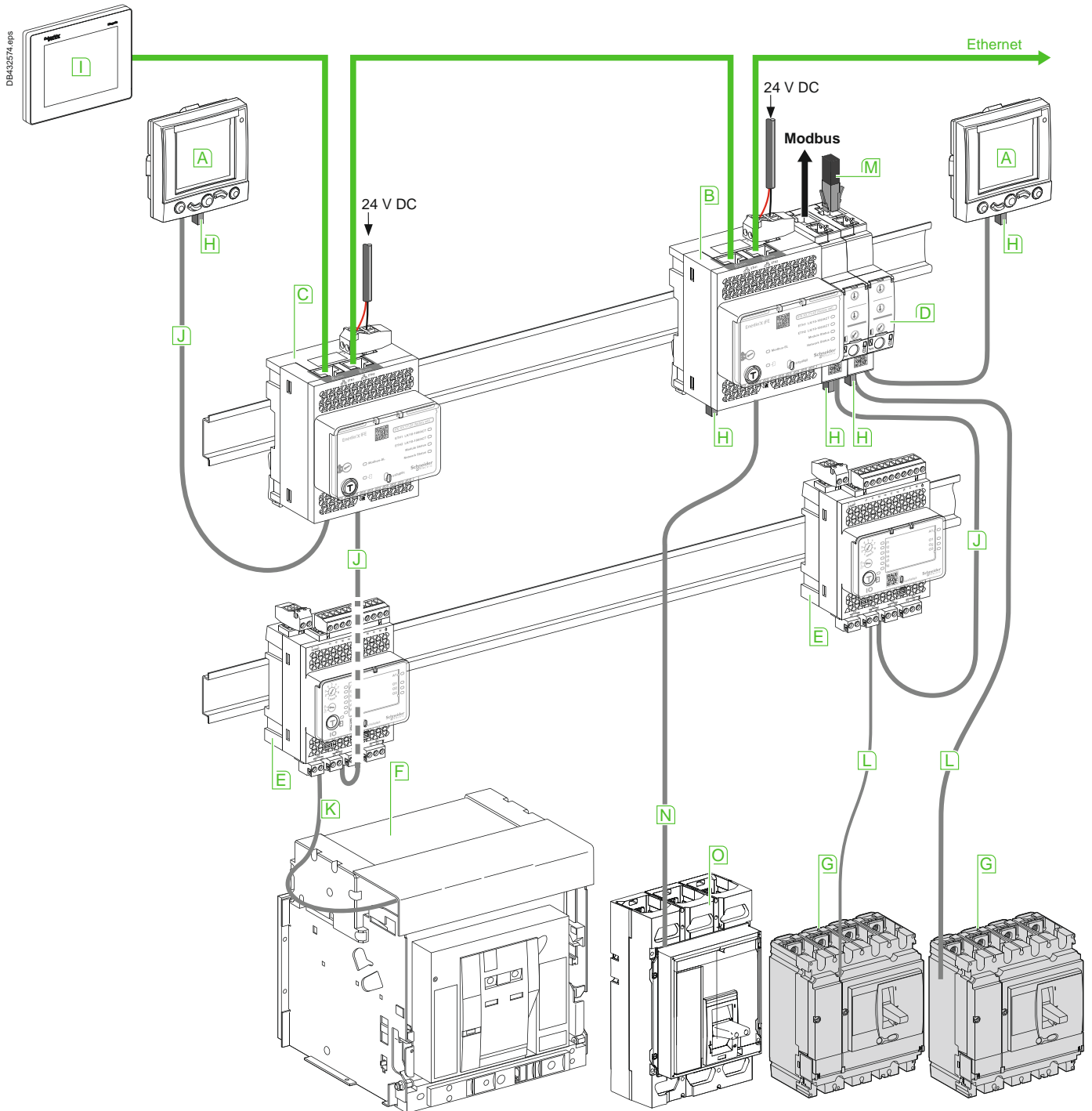

- | | | |
|--------------------------------|--|---|
| A FDM121 (TRV00121) | E I/O application module (LV434063) | I FDM128 (LV434128) |
| B IFE master (LV434002) | F Masterpact NW | M Modbus Termination ^[1] (VW3A8306RC) |
| C IFE (LV434001) | G Compact NSX | N Compact NS630b-3200 |
| D IFM (LV434000) | H ULP termination (TRV00880) | |

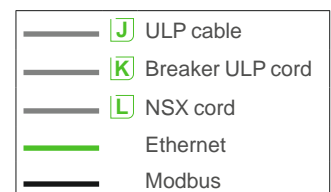

[1] Modbus termination is mandatory, see ULP system user guide TRV99101.

Compact NSX100 to 630 DC - DC PV Communication

DE432577.eps

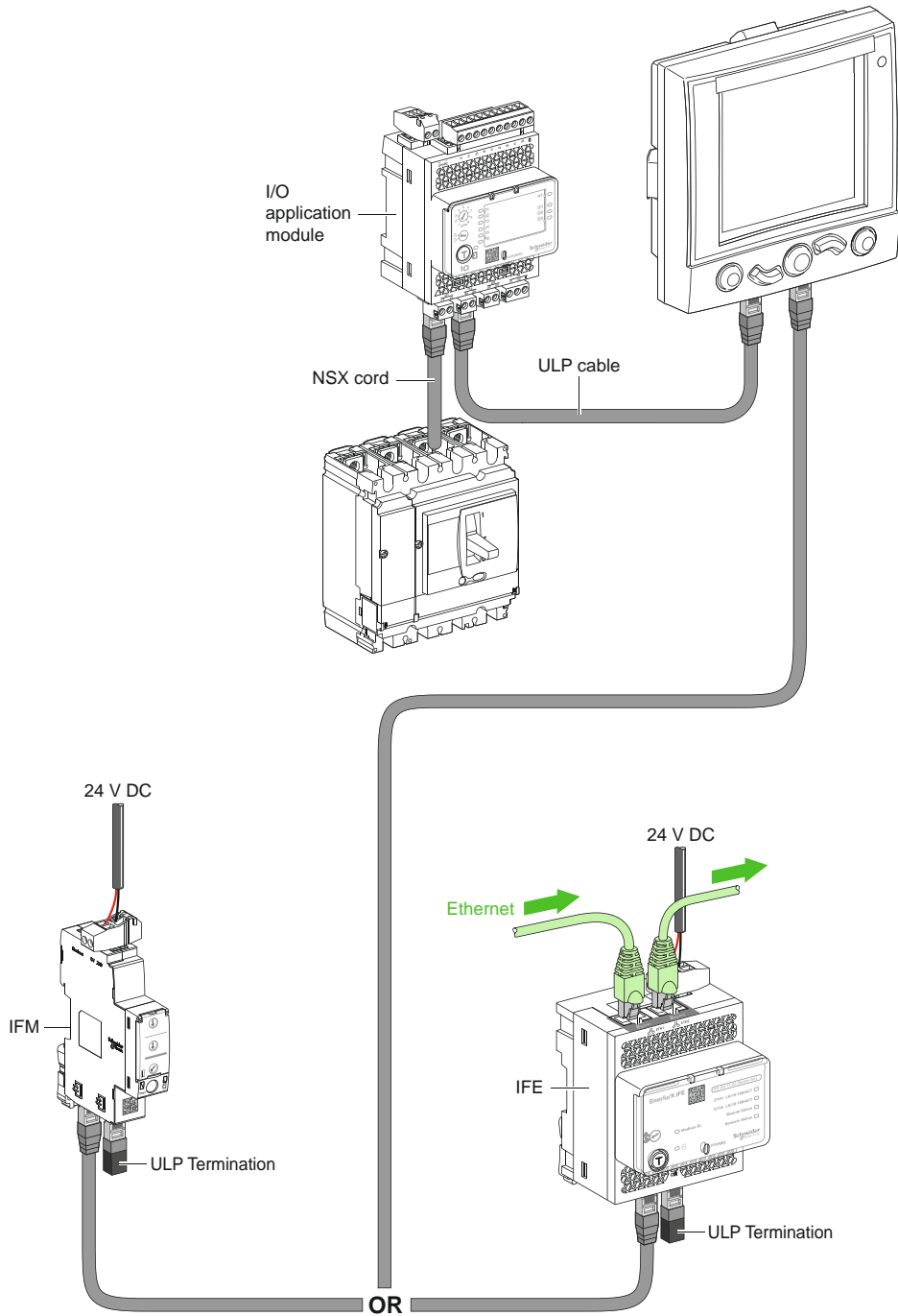

Compact NSX630b to NSX1600 DC PV Fixed switch-disconnectors

The diagram is shown with circuits de-energised, all devices open, connected and charged and relays in the normal position.

Remote operation

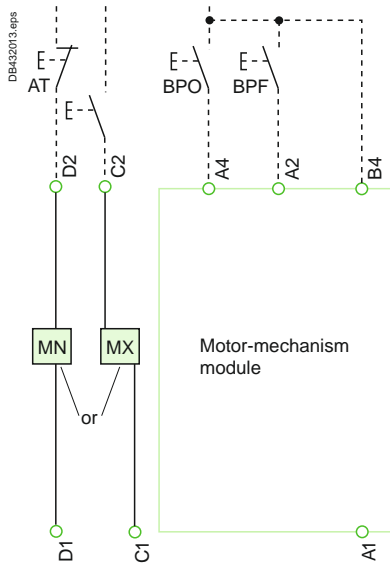

MN : undervoltage release
or
MX : shunt release

Motor-mechanism module ^[1]

A4 : electrical opening order
A2 : electrical closing order
B4, A1 : power supply for control devices and gear motor

[1] Spring-charging motor 440/480 V AC (380 V motor + additional resistor).

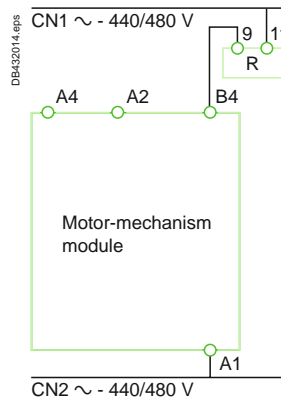

D

Compact NSX630b to NSX1600 DC PV Fixed switch-disconnectors

Indication contacts

OF3 / OF2 / OF1 : indication contacts

Terminal-block marking (electrical operation)

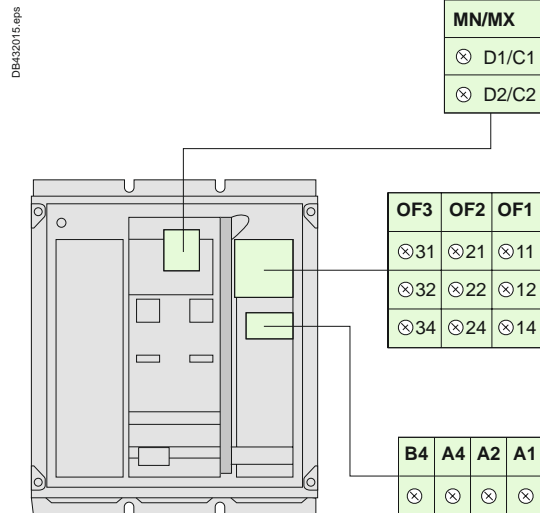

Masterpact NW10 to NW40 DC - DC PV

Fixed and drawout devices

Diagrams are shown with circuits de-energised, all devices open, connected and charged and relays in the normal position.

Version C - DC

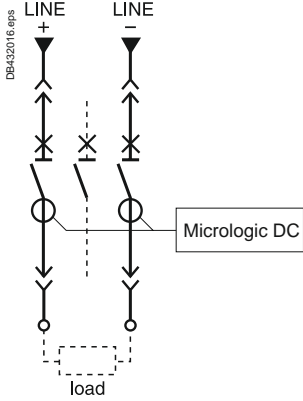

Version D - DC

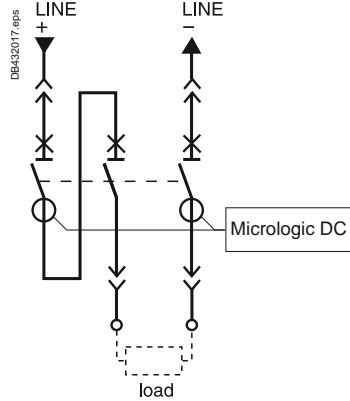

Remote operation

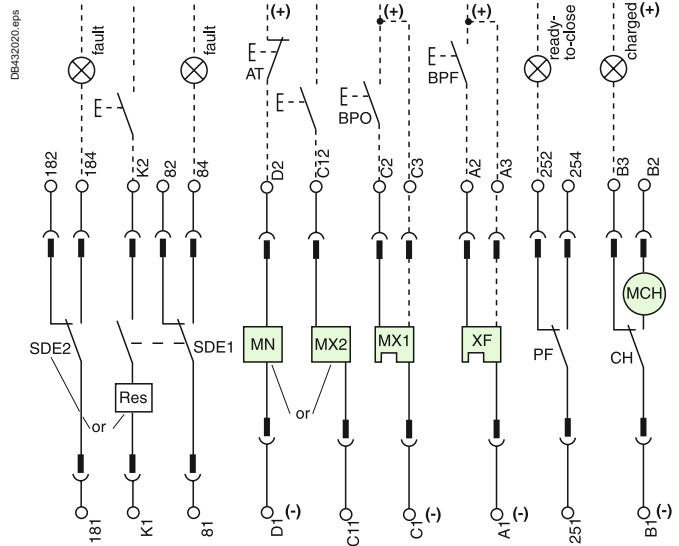

Version E - DC

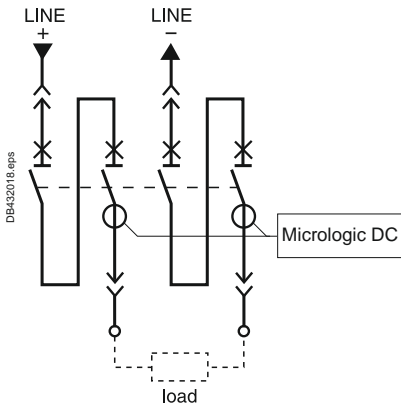

Version D - DC PV

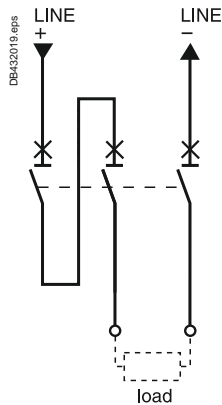

D

Control unit

Terminal block marking

Com : E1-E6 communication

- ○
- E5 E6
- ○
- E3 E4
- ○
- E1 E2

Remote operation

SDE2 / Res	SDE1	MN / MX2	MX1	XF	PF	MCH
○ ○	○ ○	○ ○	○ ○	○ ○	○ ○	○ ○
184 / K2	84	D2 / C12	C2	A2	254	B2
○ ○	○ ○		○ ○	○ ○	○ ○	○ ○
182	82		C3	A3	252	B3
○ ○	○ ○	○ ○	○ ○	○ ○	○ ○	○ ○
181 / K1	81	D1 / C11	C1	A1	251	B1

SDE2: fault-trip indication contact

or

Res: remote reset

SDE1: fault-trip indication contact (supplied as standard)

MN: undervoltage release

or

MX2: shunt release

MX1: shunt release (standard or communicating)

XF: closing release (standard or communicating)

PF: ready-to-close contact

MCH: electric motor

Note: When communicating MX or XF releases are used, the third wire (C3,A3) must be connected even if the communication module is not installed.

Masterpact NW10 to NW40 DC - DC PV

Fixed and drawout devices

Indication contacts

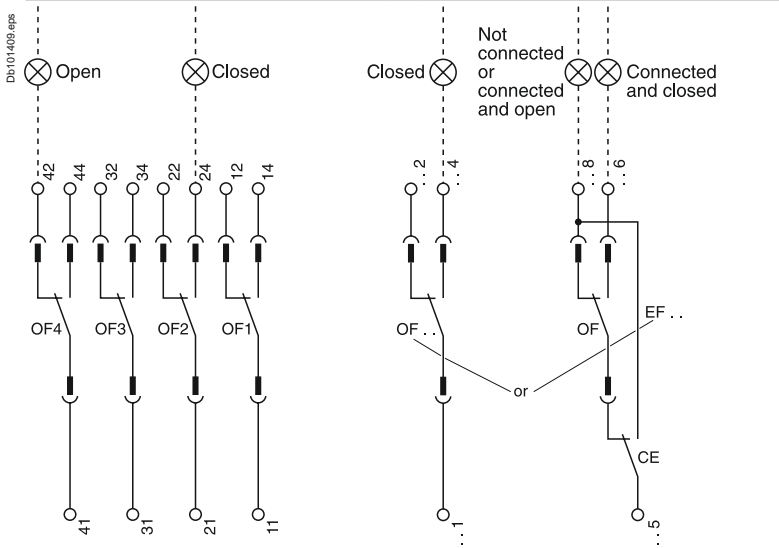

Chassis contacts

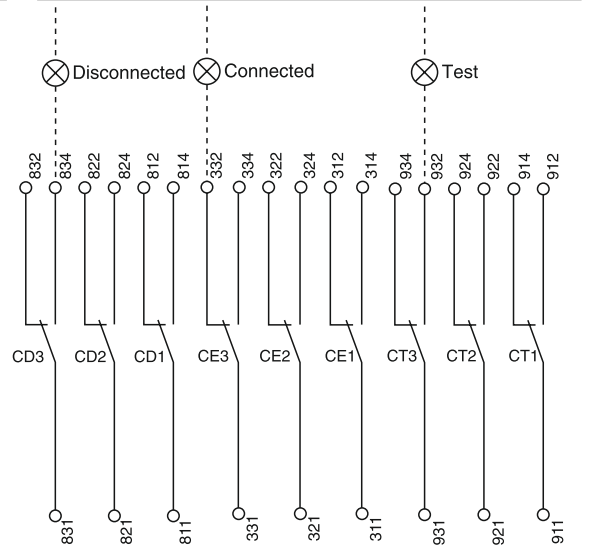

Indication contacts

OF4	OF3	OF2	OF1	OF24	OF23	OF22	OF21	OF14	OF13	OF12	OF11
44	34	24	14	244	234	224	214	144	134	124	114
42	32	22	12	242	232	222	212	142	132	122	112
41	31	21	11	241	231	221	211	141	131	121	111
				or	or	or	or	or	or	or	or
EF24	EF23	EF22	EF21	EF14	EF13	EF12	EF11				
248	238	228	218	148	138	128	118				
246	236	226	216	146	136	126	116				
245	235	225	215	145	135	125	115				

Chassis contacts

CD3	CD2	CD1	CE3	CE2	CE1	CT3	CT2	CT1
834	824	814	334	324	314	934	924	914
832	822	812	332	322	312	932	922	912
831	821	811	331	321	311	931	921	911
			or				or	
CE6	CE5	CE4				CE9	CE8	CE7
364	354	344				394	384	374
362	352	342				392	382	372
361	351	341				391	381	371

Indication contacts

OF4	ON/OFF indication contacts	OF24	ON/OFF indication contacts
OF3		or	
OF2		EF24	Combined "connected-closed" indication contacts
OF1			
		OF22 or EF22	
		OF21 or EF21	
		OF14 or EF14	
		OF13 or EF13	
		OF12 or EF12	
		OF11 or EF11	

Chassis contacts

CD3	Disconnected position contacts	CE3	Connected position contacts	CT3	Test position contacts
CD2		CE2		CT2	
CD1		CE1		CT1	
or			or		
CE6	Connected position contacts	CE9	Connected position contacts	CE8	Connected position contacts
CE5		CE7		CE7	
CE4		or			
		CD6	Disconnected position contacts	CD5	Disconnected position contacts
		CD4		CD4	

Legend:

- Drawout device only.
- SDE1, OF1, OF2, OF3, OF4 supplied as standard.
- Interconnected connections (only one wire per connection point).



Masterpact NW DC - DC PV Communication

Communication architecture

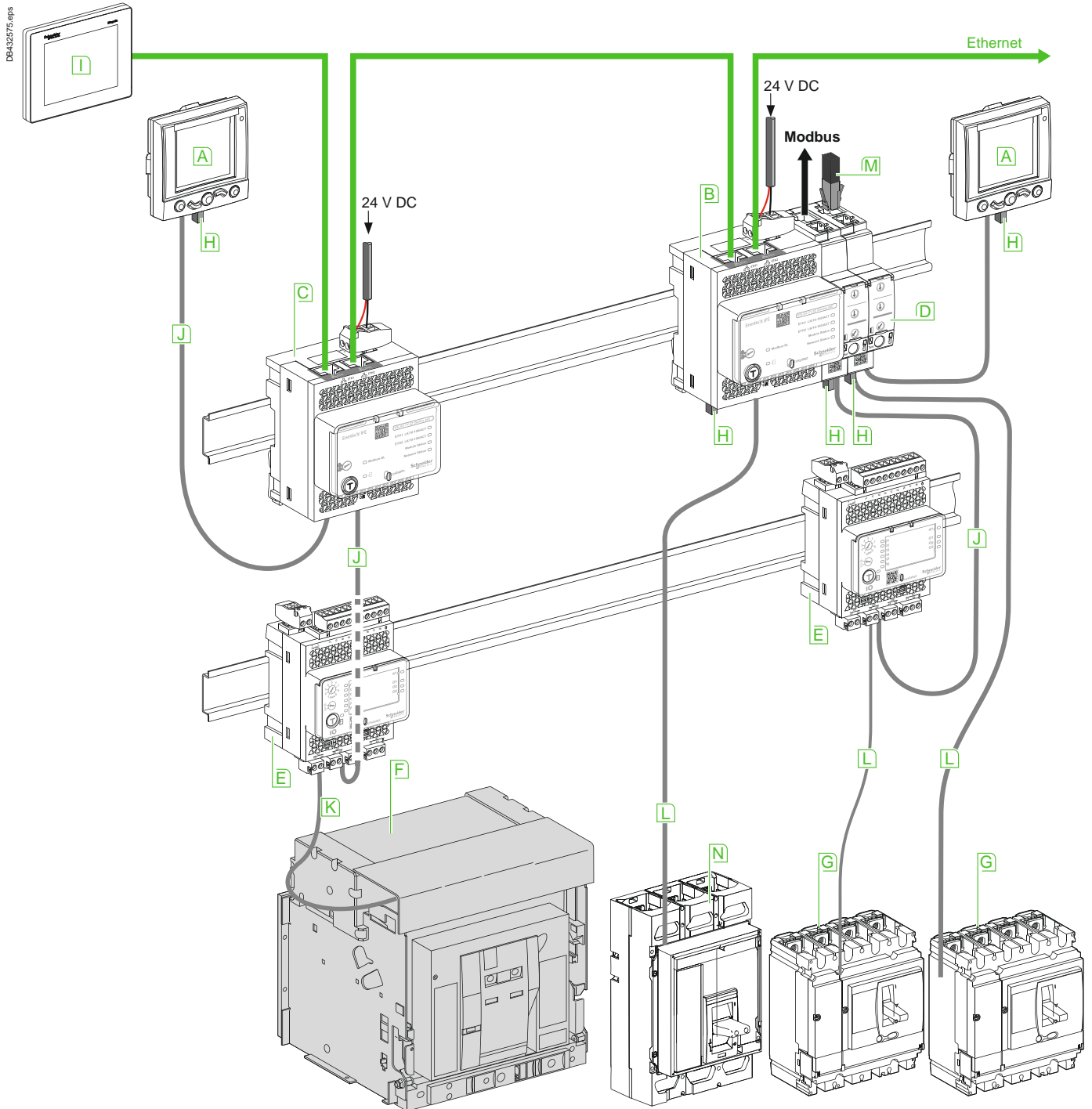

- | | | |
|--------------------------------|--|---|
| A FDM121 (TRV00121) | E I/O application module (LV434063) | I FDM128 (LV434128) |
| B IFE master (LV434002) | F Masterpact NW | M Modbus Termination ^[1] (VW3A8306RC) |
| C IFE (LV434001) | G Compact NSX | N Compact NS630b-3200 |
| D IFM (LV434000) | H ULP termination (TRV00880) | |

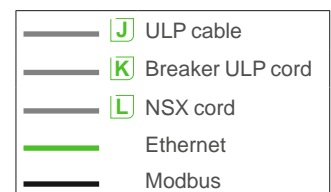

[1] Modbus termination is mandatory, see ULP system user guide TRV99101.

Fixed, electrically operated Masterpact NW DC - DC PV

Connection to the communication interface module

DB-425546-01ns

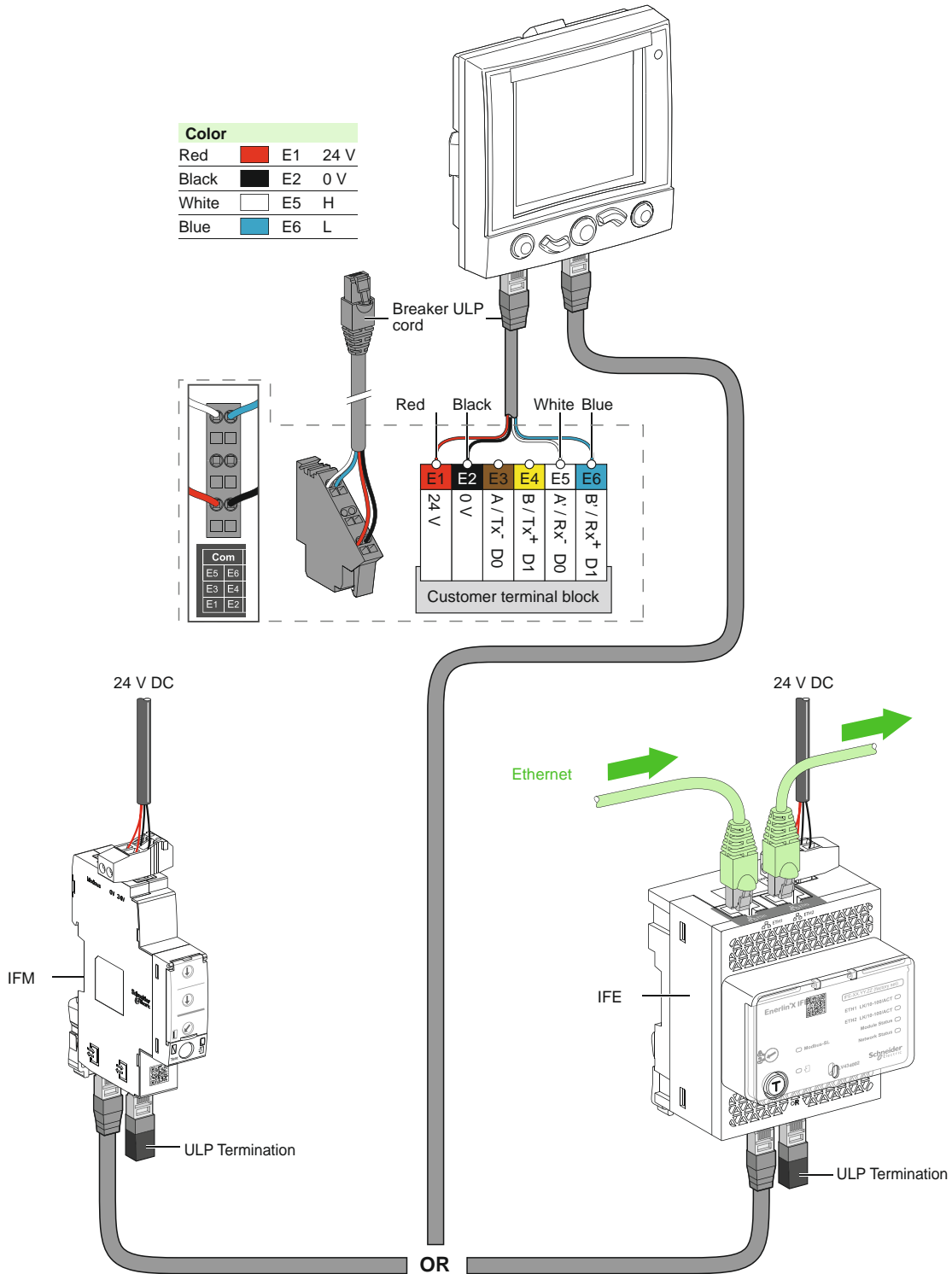

Withdrawable Masterpact NW DC - DC PV

Connection to the I/O and communication interface module

DB432576/495

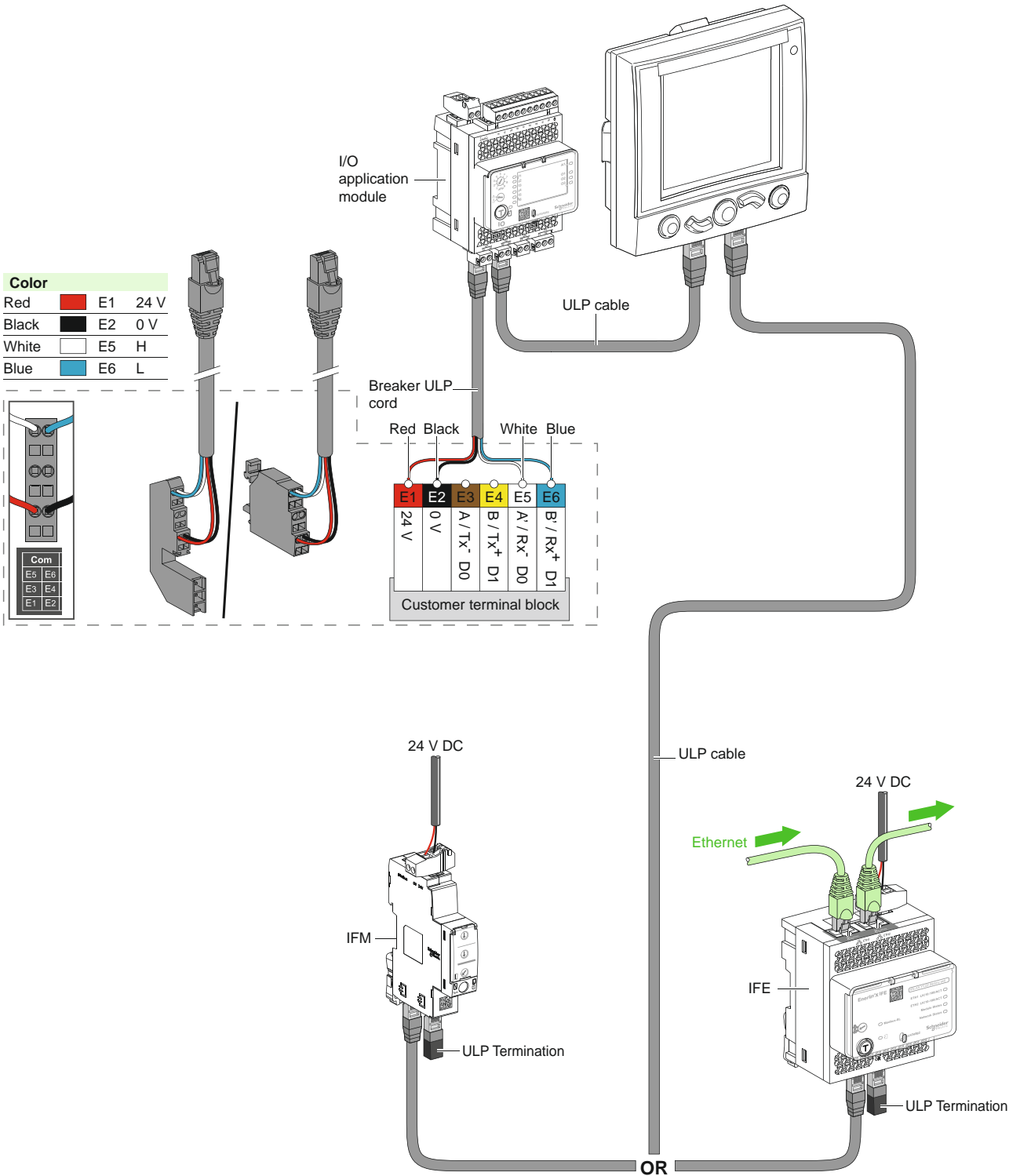

D

Additional characteristics

Compact NSX100 to 250 DC	
TM-DC magnetic trip units, tripping curves	E-2
TMG magnetic trip units, tripping curves.....	E-5
Compact NSX400 to 630 DC	
TM-DC trip units, tripping curves	E-8
Compact NSX630 to 1200 DC	
TM-DC trip units, tripping curves	E-10
Current and energy limiting curves	
Compact NSX DC.....	E-12
Compact NSX80 to 500 DC PV	
TM-DC PV magnetic trip units, tripping curves	E-14
Masterpact NW10 to NW40 DC	
Tripping curves U = 500 V DC, L/R = 5 ms.....	E-16
Tripping curves U = 750/900 V DC, L/R = 5 ms.....	E-17
Tripping curves U = 500 V DC, L/R = 15 ms.....	E-18
Tripping curves U = 750/900 V DC, L/R = 15 ms.....	E-19
Tripping curves U = 500/750 V DC, L/R = 30 ms.....	E-20
Tripping curves U = 900 V DC, L/R = 30 ms.....	E-21



Other chapters	
Presentation.....	2
Functions and characteristics	A-1
Installation recommendations	B-1
Dimensions and connection	C-1
Electrical diagrams	D-1
Catalogue numbers and order form	F-1

Compact NSX100 to 250 DC

TM-DC magnetic trip units, tripping curves

TM-DC 16

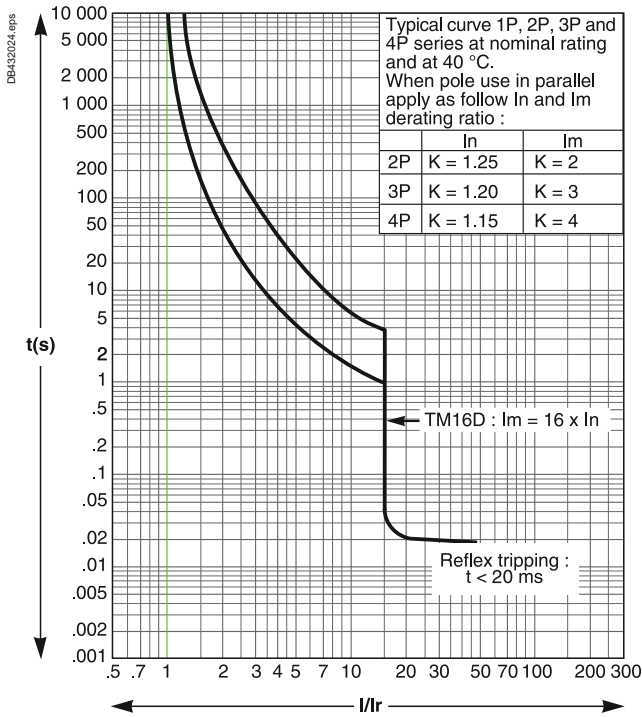

Reflex tripping.

TM-DC 25

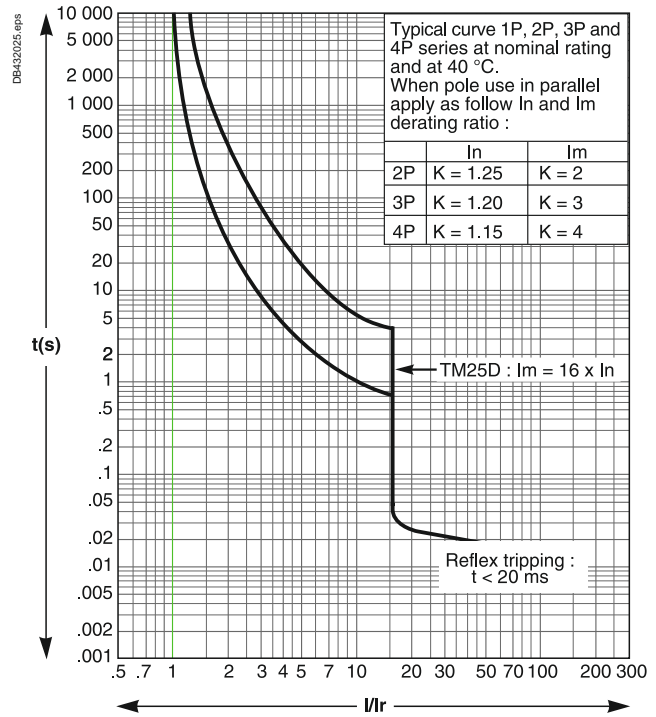

TM-DC 30/TM-DC 32

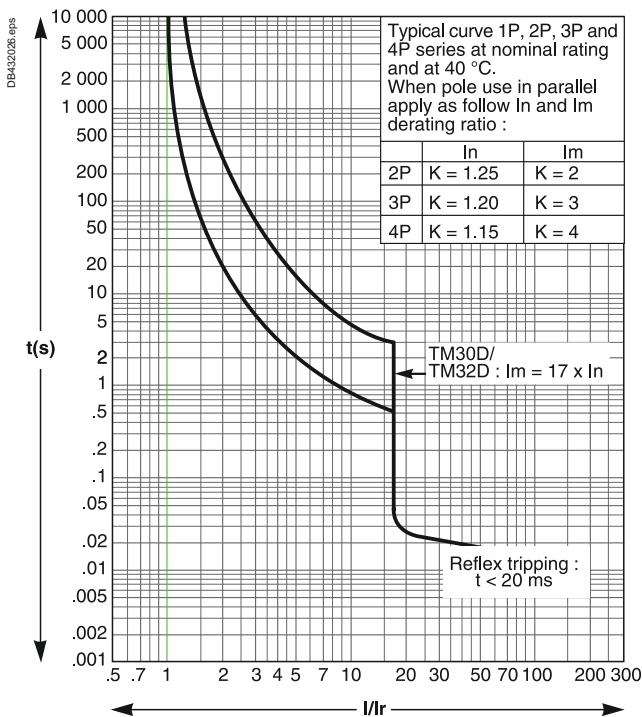

Reflex tripping.

TM-DC 40

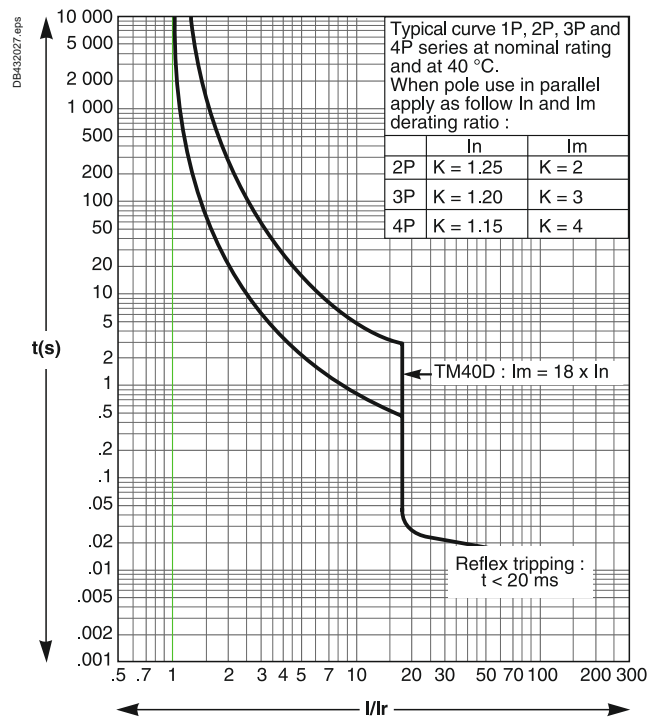

Compact NSX100 to 250 DC TM-DC magnetic trip units, tripping curves

TM-DC 50

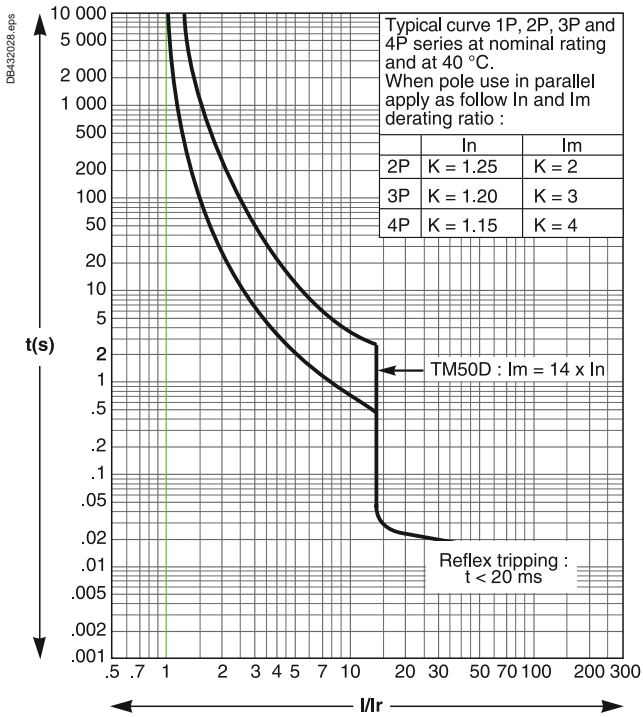

TM-DC 63

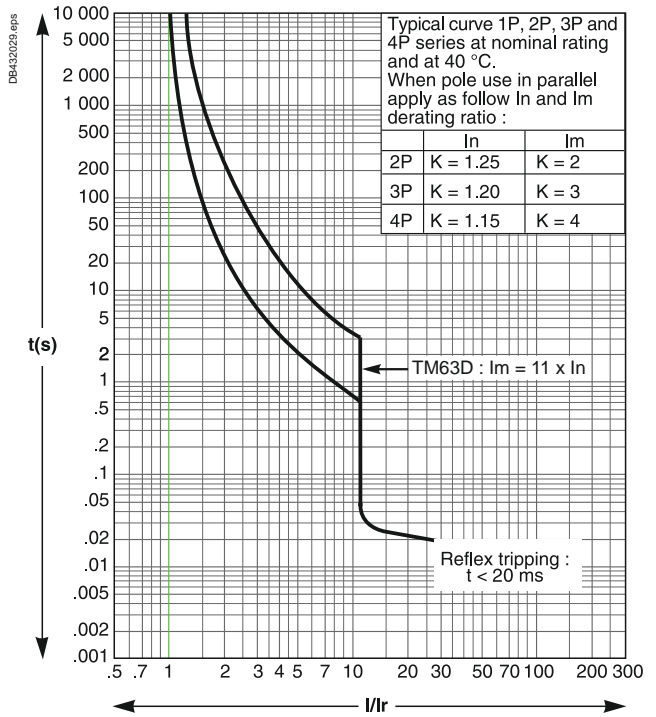

TM-DC 80

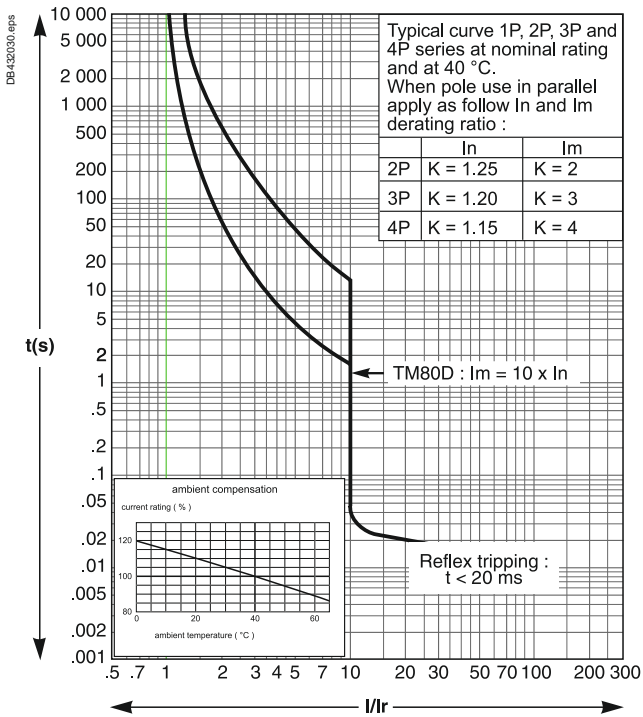

TM-DC 100

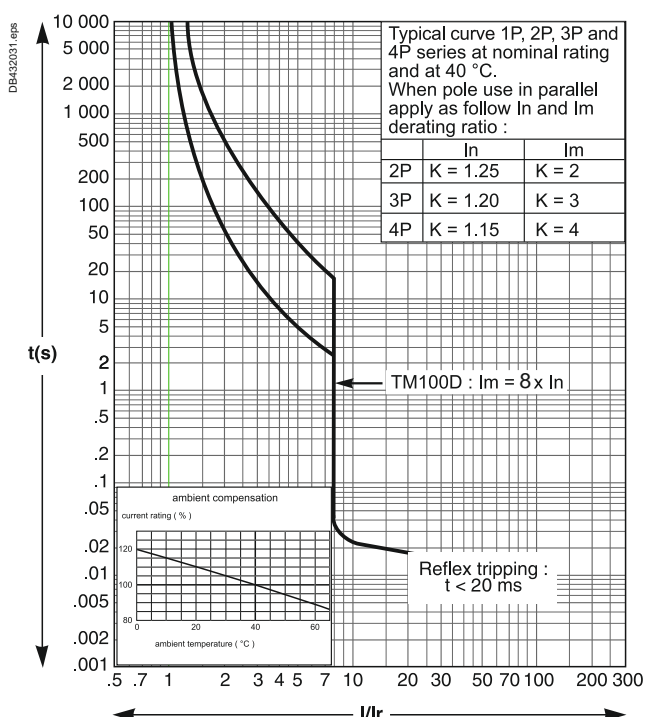

Compact NSX100 to 250 DC

TM-DC magnetic trip units, tripping curves

TM-DC 125

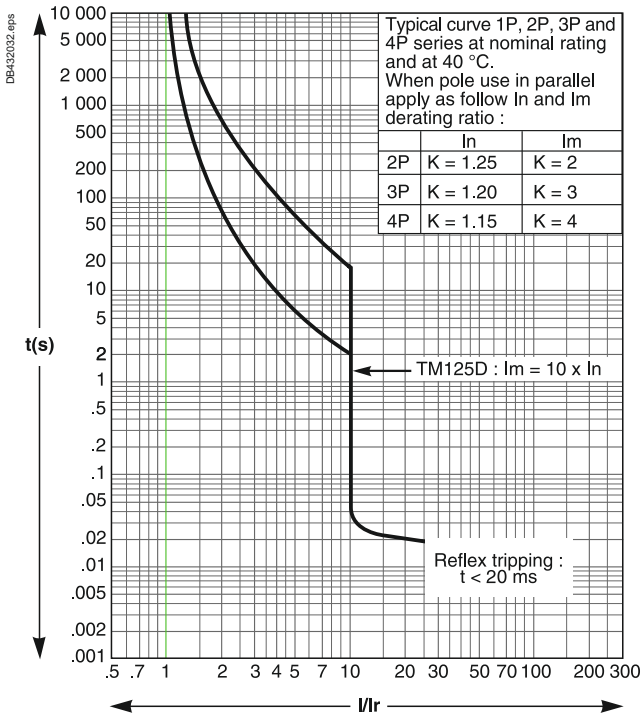

TM-DC 160

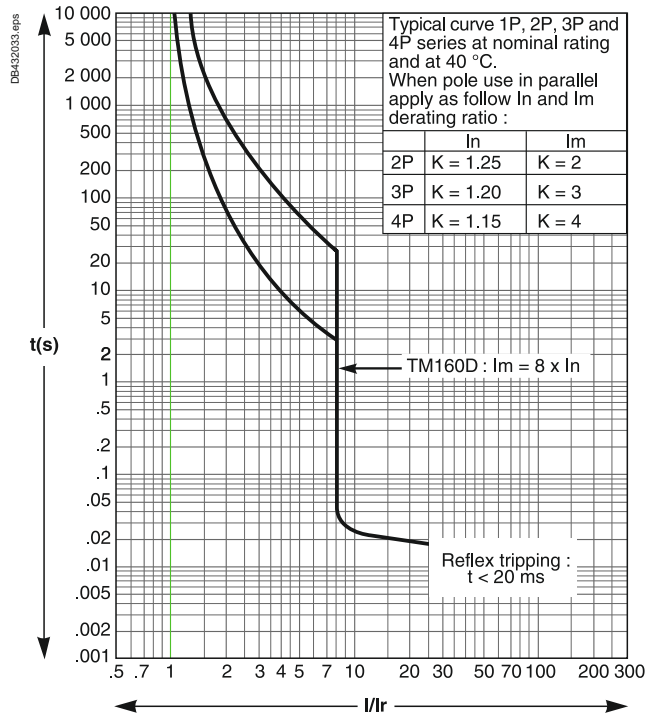

TM-DC 200

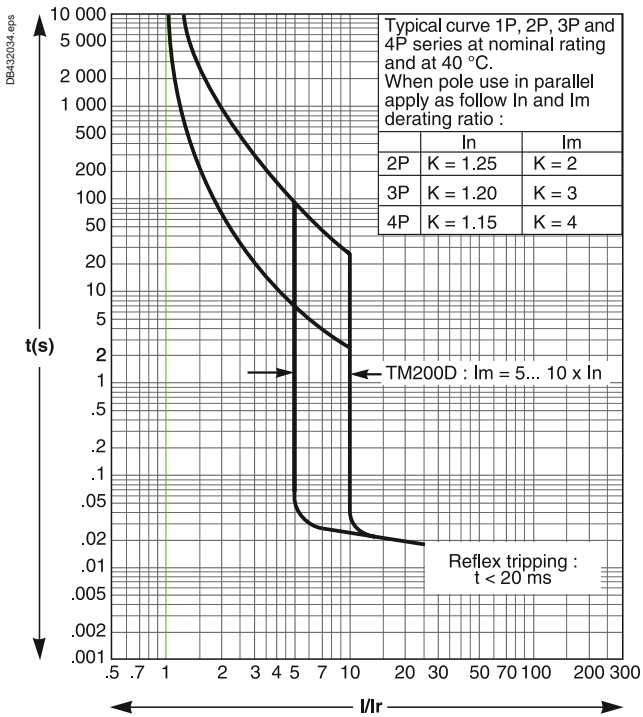

TM-DC 250

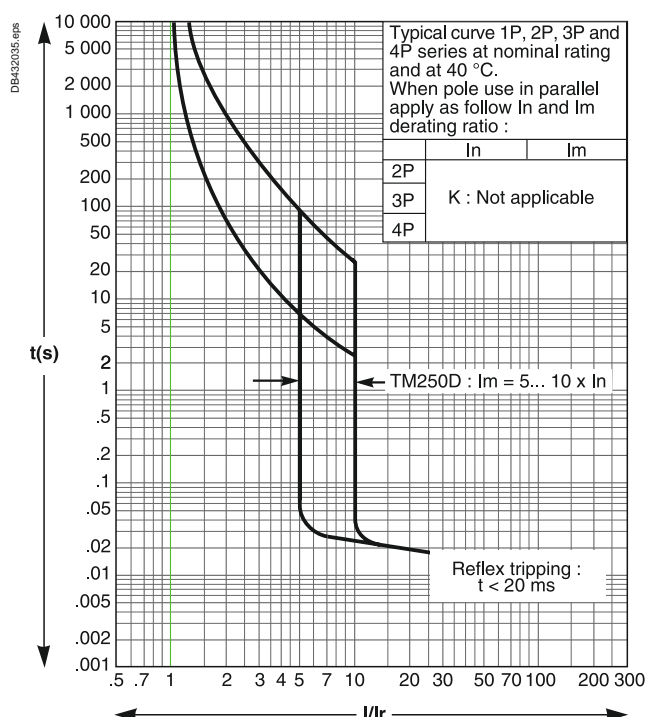

E

Compact NSX100 to 250 DC TMG magnetic trip units, tripping curves

TM16G

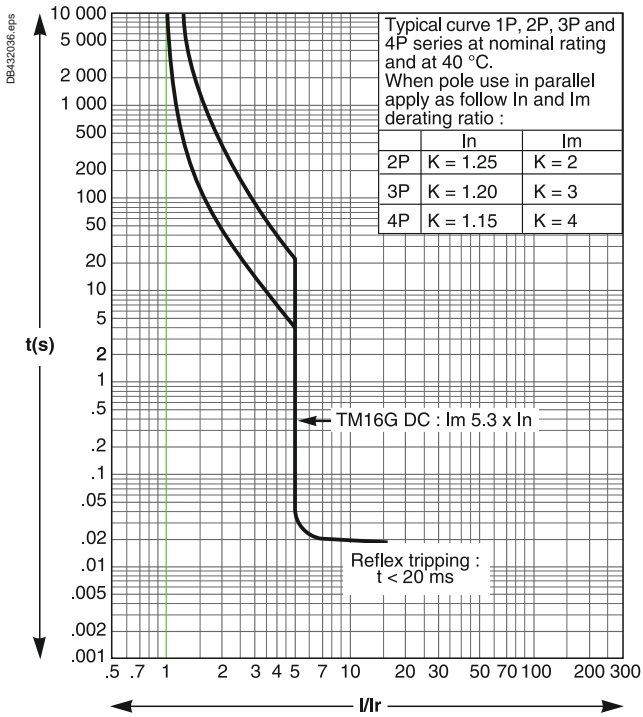

TM25G

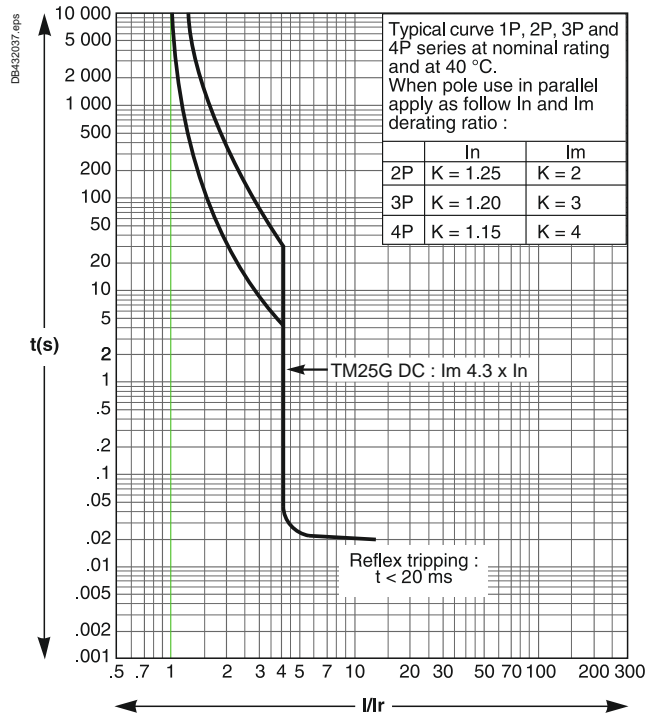

TM40G

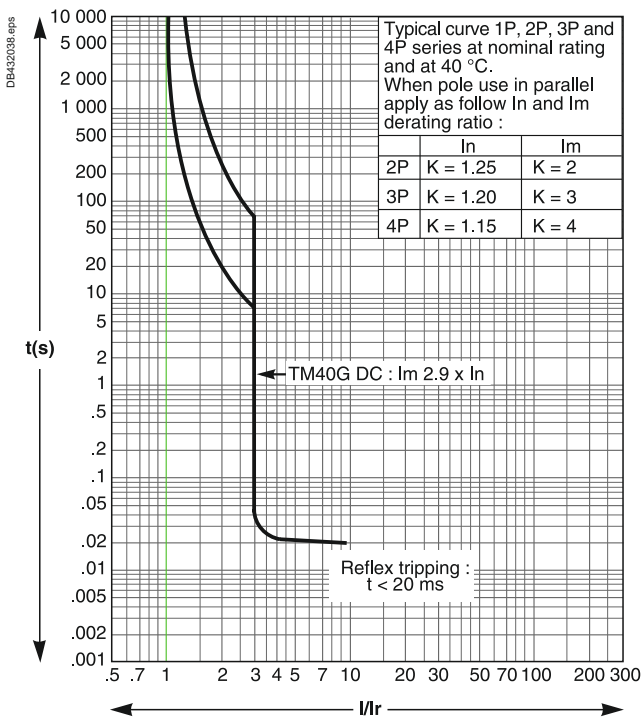

TM63G

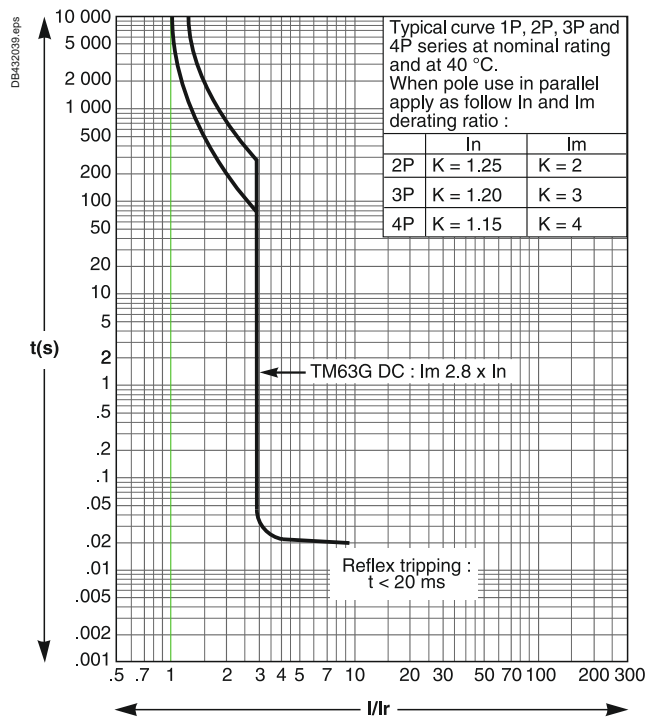

Compact NSX100 to 250 DC

TMG magnetic trip units, tripping curves

TM80G

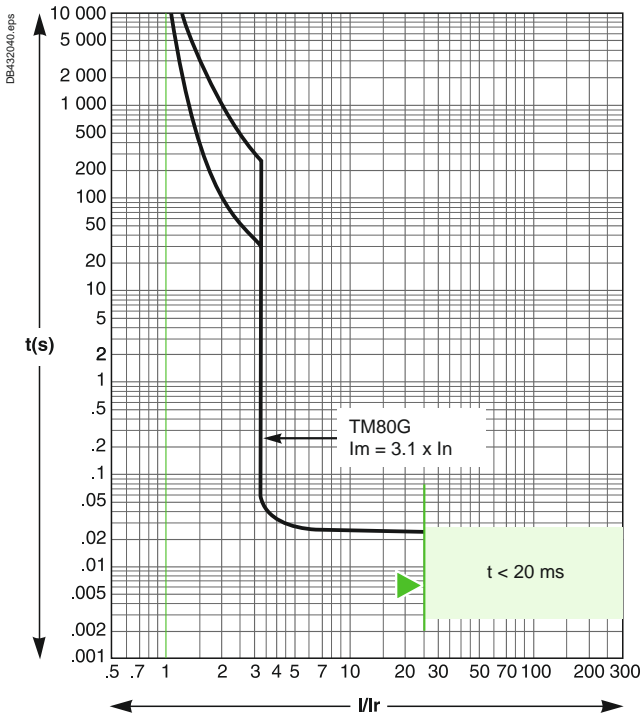

TM100G

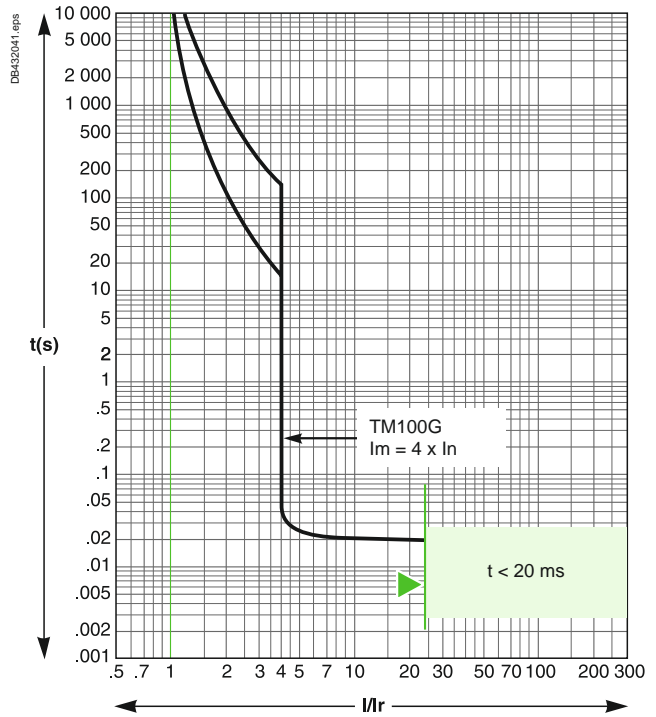

TM125G

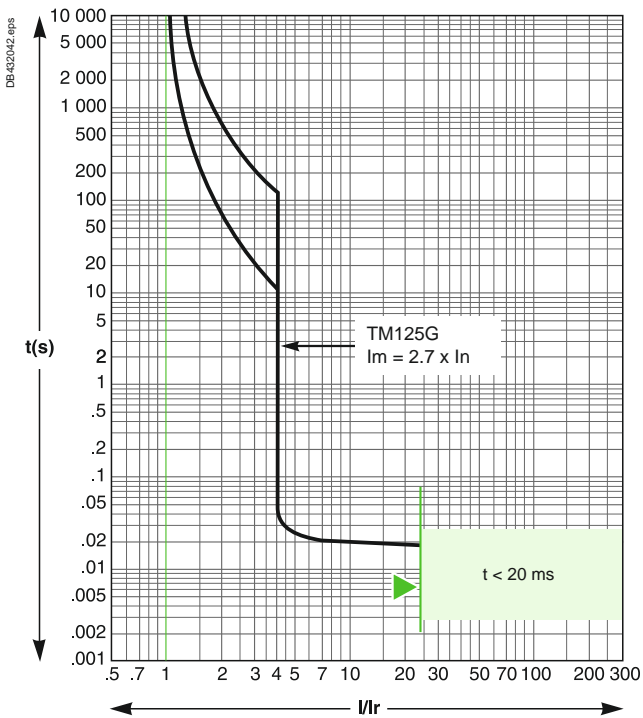

TM160G

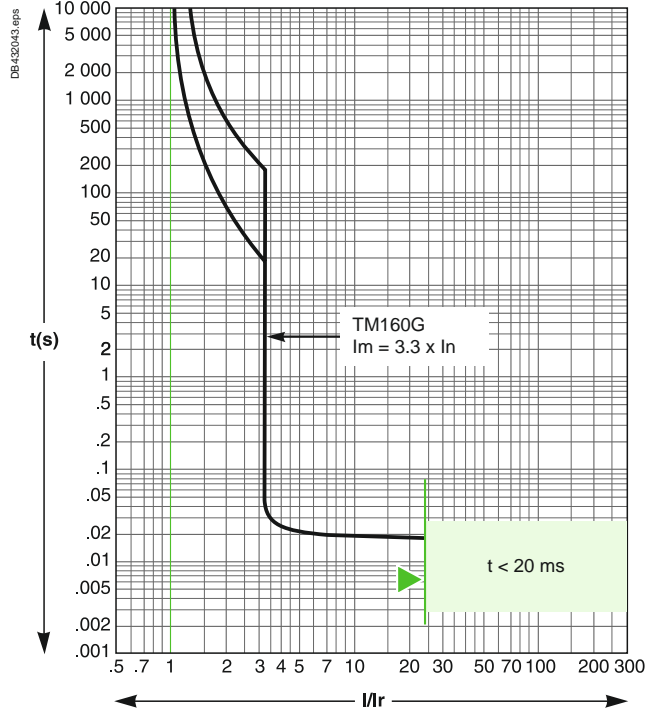

E

Compact NSX100 to 250 DC TMG magnetic trip units, tripping curves

TM200G

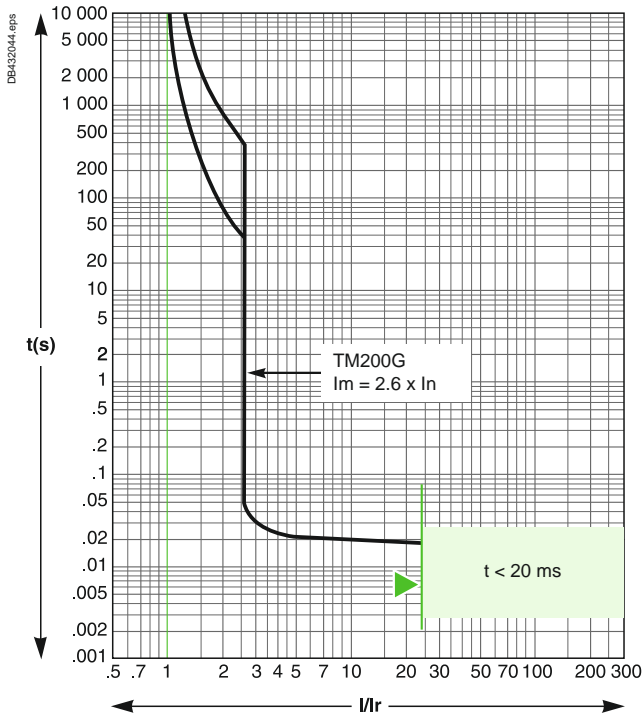

TM250G

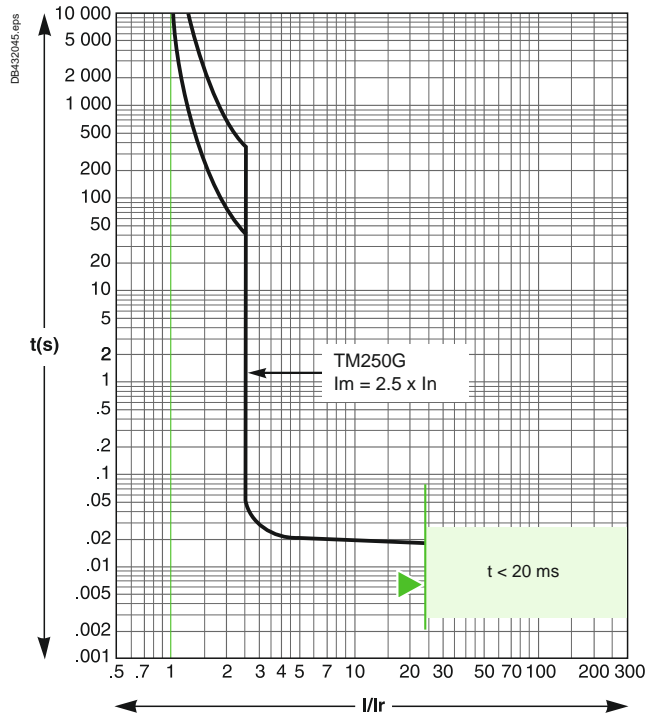

Compact NSX400 to 630 DC

TM-DC trip units, tripping curves

TM-DC 250

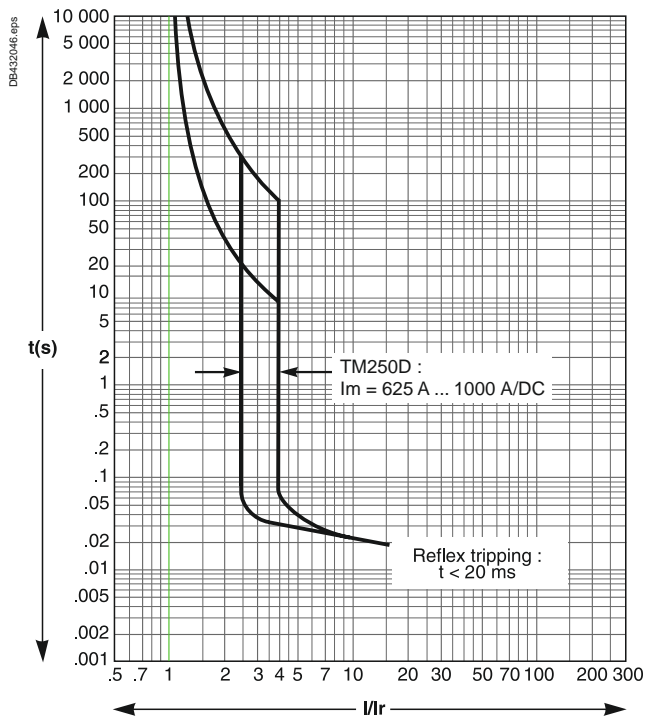

TM-DC 320

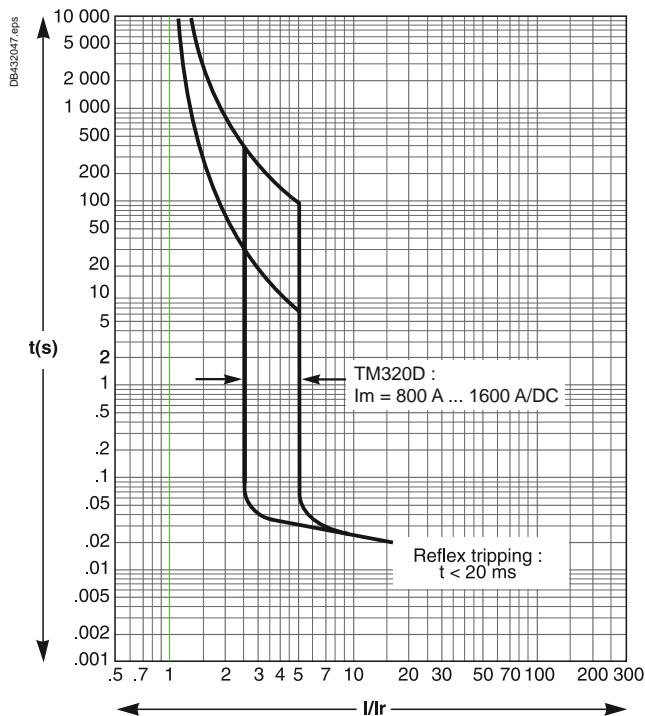

TM-DC 400

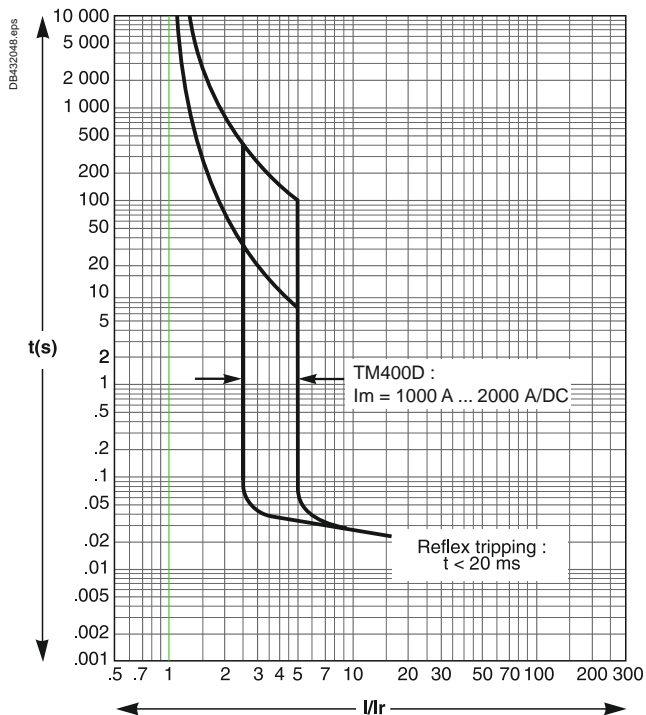

TM-DC 500

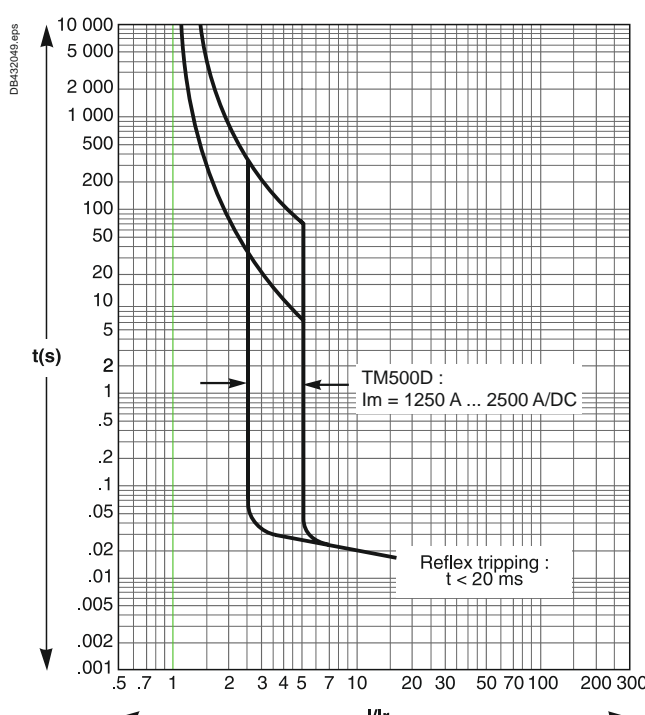

E

Compact NSX400 to 630 DC TM-DC trip units, tripping curves

TM-DC 600

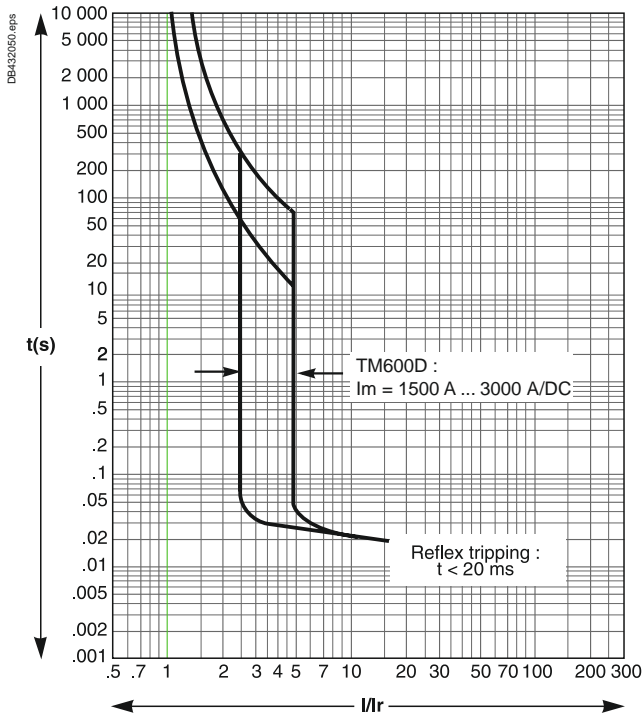

Compact NSX630 to 1200 DC

TM-DC trip units, tripping curves

TM-DC 630

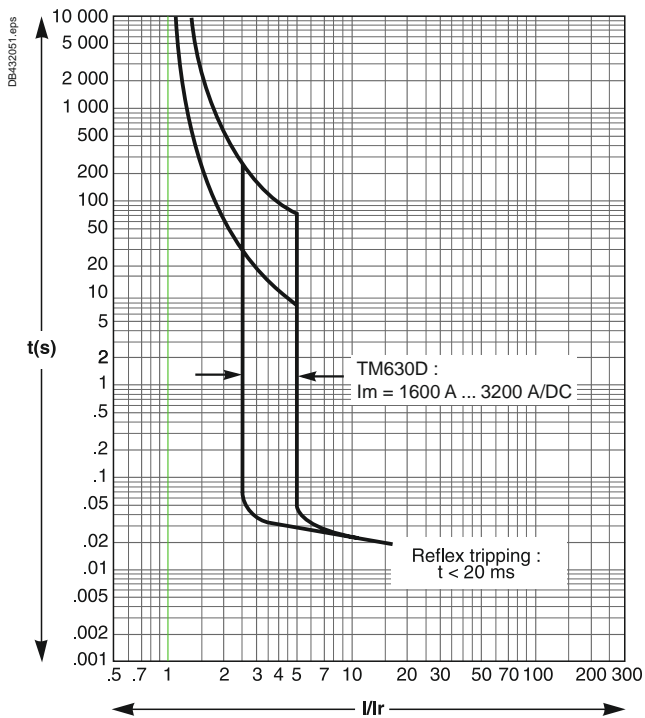

TM-DC 800

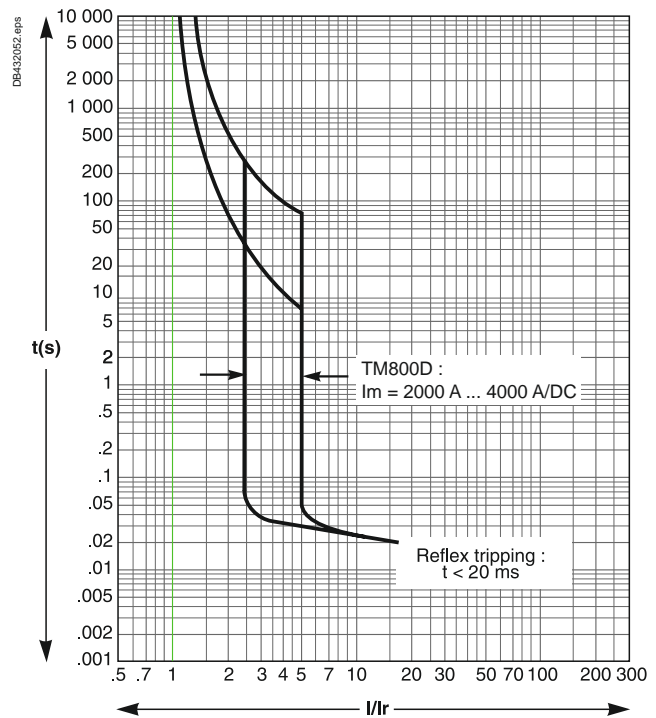

TM-DC 1000

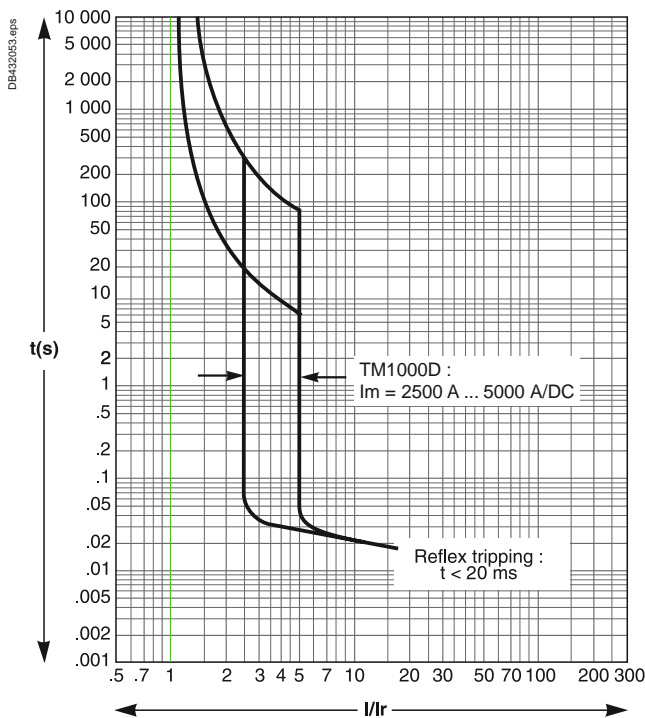

TM-DC 1200

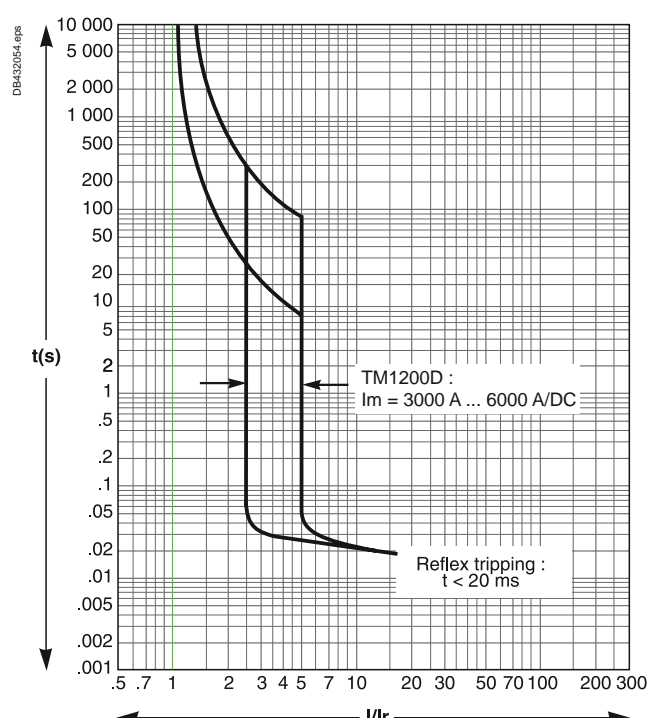

E

Current and energy limiting curves

The limiting capacity of a circuit breaker is its aptitude to let through a current, during a short-circuit, that is less than the prospective short-circuit current.

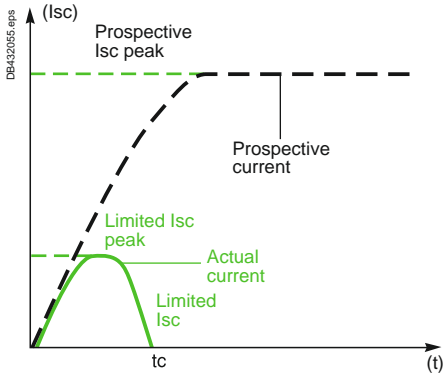

The exceptional limiting capacity of the Compact NSX DC range is due to the rotating double-break technique (very rapid natural repulsion of contacts and the appearance of two arc voltages in-series with a very steep wave front).

Ics = 100 % Icu

The exceptional limiting capacity of the Compact NSX DC range greatly reduces the forces created by fault currents in devices.

The result is a major increase in breaking performance.

In particular, the service breaking capacity Ics is equal to 100 % of Icu.

The Ics value, defined by IEC standard 60947-2, is guaranteed by tests comprising the following steps:

- break three times consecutively a fault current equal to 100 % of Icu
- check that the device continues to function normally, that is:
 - it conducts the rated current without abnormal temperature rise
 - protection functions perform within the limits specified by the standard
 - suitability for isolation is not impaired.

Longer service life of electrical installations

Current-limiting circuit breakers greatly reduce the negative effects of short-circuits on installations.

Thermal effects

Less temperature rise in conductors, therefore longer service life for cables.

Mechanical effects

Reduced electrodynamic forces, therefore less risk of electrical contacts or busbars being deformed or broken.

Electromagnetic effects

Fewer disturbances for measuring devices located near electrical circuits.

Current and energy limiting curves

The limiting capacity of a circuit breaker is expressed by two curves which are a function of the prospective short-circuit current (the current which would flow if no protection devices were installed):

- the actual peak current (limited current)
- thermal stress (A²s), i.e. the energy dissipated by the short-circuit in a conductor with a resistance of 1 Ω.

Example

What is the real value of a 150 kA rms prospective short-circuit (i.e. 330 kA peak) limited by an NSX250L DC upstream ?

The answer is 30 kA peak (curve [page E-12](#)).

Maximum permissible cable stresses

The table below indicates the maximum permissible thermal stresses for cables depending on their insulation, conductor (Cu or Al) and their cross-sectional area (CSA). CSA values are given in mm² and thermal stresses in A²s.

CSA		1.5 mm ²	2.5 mm ²	4 mm ²	6 mm ²	10 mm ²
PVC	Cu	2.97 x 10 ⁴	8.26 x 10 ⁴	2.12 x 10 ⁵	4.76 x 10 ⁵	1.32 x 10 ⁶
	Al					5.41 x 10 ⁵
PRC	Cu	4.10 x 10 ⁴	1.39 x 10 ⁵	2.92 x 10 ⁵	6.56 x 10 ⁵	1.82 x 10 ⁶
	Al					7.52 x 10 ⁵
CSA		16 mm ²	25 mm ²	35 mm ²	50 mm ²	
PVC	Cu	3.4 x 10 ⁶	8.26 x 10 ⁶	1.62 x 10 ⁷	3.31 x 10 ⁷	
	Al	1.39 x 10 ⁶	3.38 x 10 ⁶	6.64 x 10 ⁶	1.35 x 10 ⁷	
PRC	Cu	4.69 x 10 ⁶	1.39 x 10 ⁷	2.23 x 10 ⁷	4.56 x 10 ⁷	
	Al	1.93 x 10 ⁶	4.70 x 10 ⁶	9.23 x 10 ⁶	1.88 x 10 ⁷	

Example

Is a Cu/PVC cable with a CSA of 10 mm² adequately protected by an NSX160F.

The table above indicates that the permissible stress is 1.32x10⁶ A²s.

All short-circuit currents at the point where an NSX160F (Icu = 35 kA) is installed are limited with a thermal stress less than 6x10⁵ A²s (curve [page E-12](#)).

Cable protection is therefore ensured up to the limit of the breaking capacity of the circuit breaker.

Current and energy limiting curves Compact NSX DC

Current-limiting curves and thermal stress for L/R = 5 ms

Peak current
 U < 250 V DC: 1P
 250 V < U < 500 V DC: 2P
 500 V < U < 750 V DC: 3P

Thermal stress
 U < 250 V DC: 1P
 250 V < U < 500 V DC: 2P

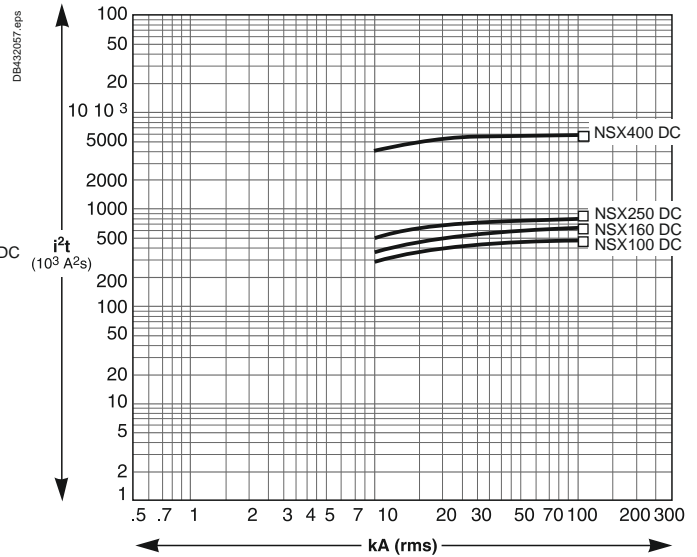
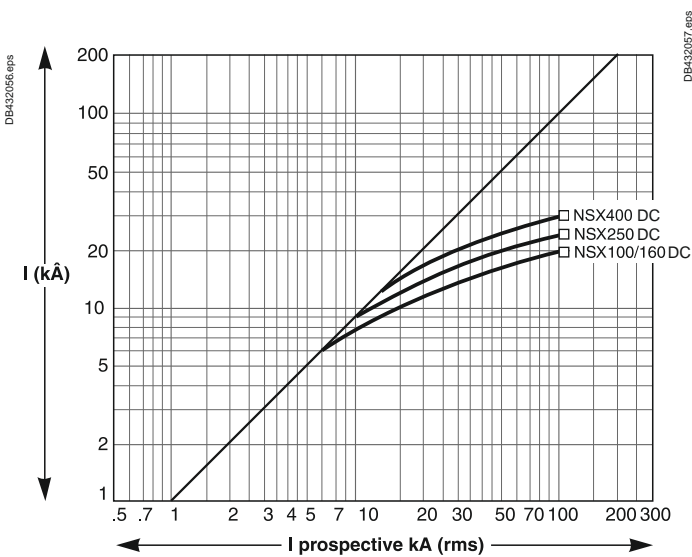

Current-limiting curves and thermal stress for L/R = 15 ms

Peak current
 U < 250 V DC: 1P
 250 V < U < 500 V DC: 2P
 500 V < U < 750 V DC: 3P

Thermal stress
 U < 250 V DC: 1P
 250 V < U < 500 V DC: 2P

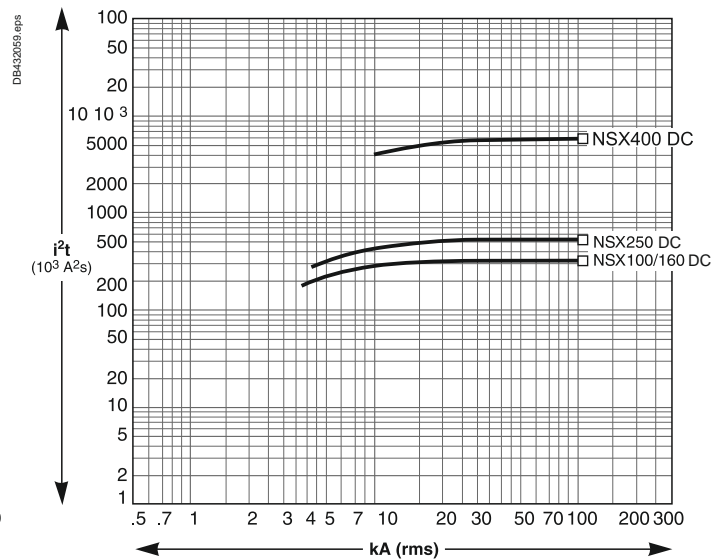
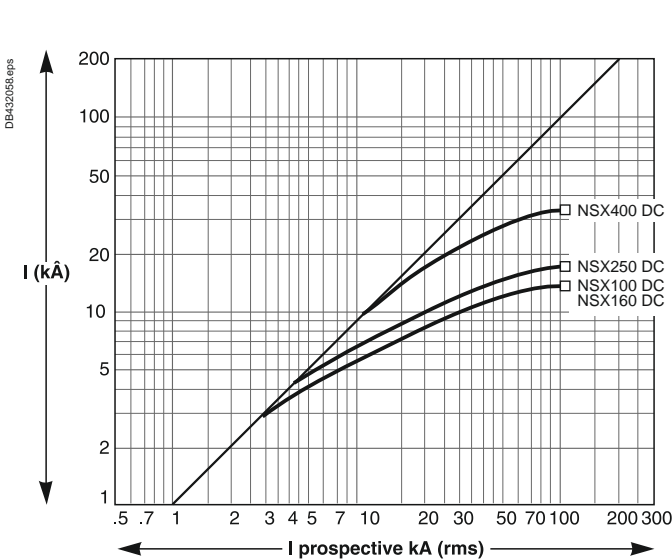

E

Current and energy limiting curves Compact NSX DC

Current-limiting curves and thermal stress for L/R = 5 ms

Peak current
 $U \leq 250 \text{ V DC}$: 1P
 $250 \text{ V} < U < 600 \text{ V DC}$: 2P
 $600 \text{ V} < U < 750 \text{ V DC}$: 3P

Thermal stress
 $U \leq 250 \text{ V DC}$: 1P
 $250 \text{ V} < U < 600 \text{ V DC}$: 2P

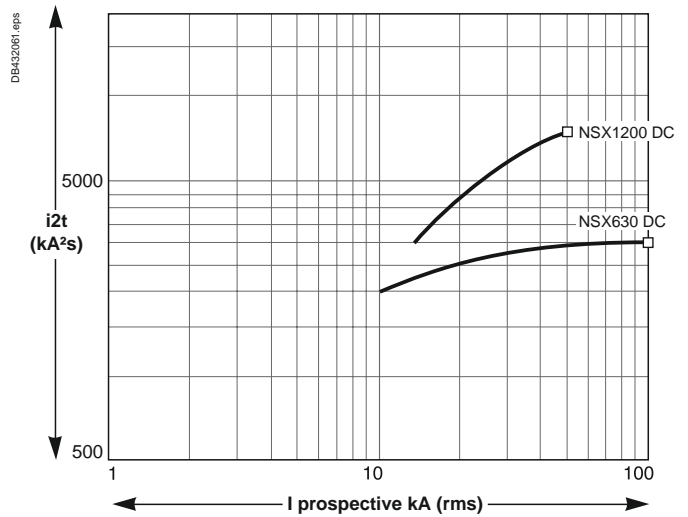
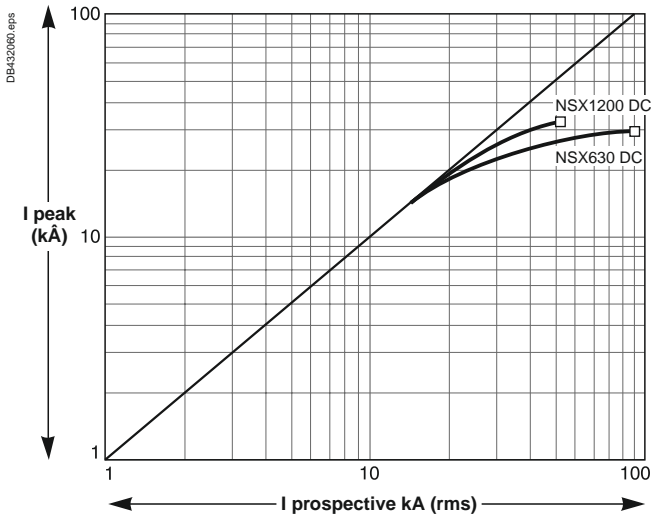

Current-limiting curves and thermal stress for L/R = 15 ms

Peak current
 $U \leq 250 \text{ V DC}$: 1P
 $250 \text{ V} < U < 600 \text{ V DC}$: 2P
 $600 \text{ V} < U < 750 \text{ V DC}$: 3P

Thermal stress
 $U \leq 250 \text{ V DC}$: 1P
 $250 \text{ V} < U < 600 \text{ V DC}$: 2P

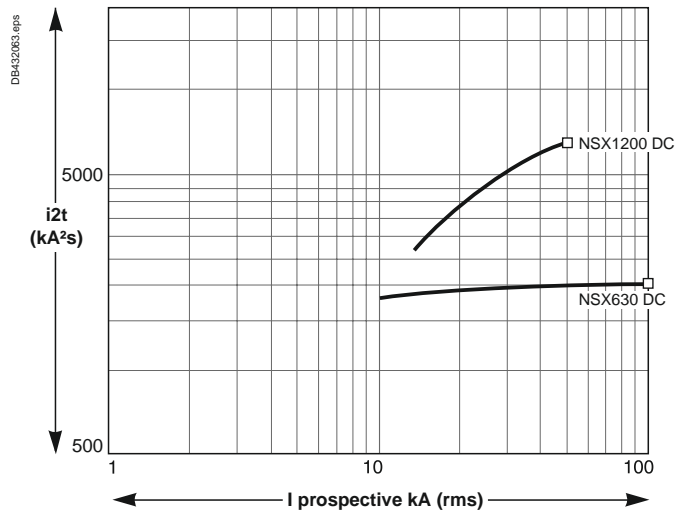
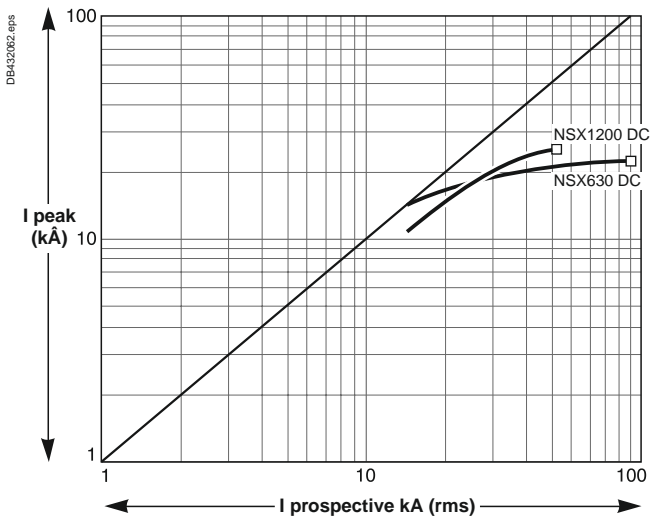

Compact NSX80 to 500 DC PV TM-DC PV magnetic trip units, tripping curves

TM-DC PV 80

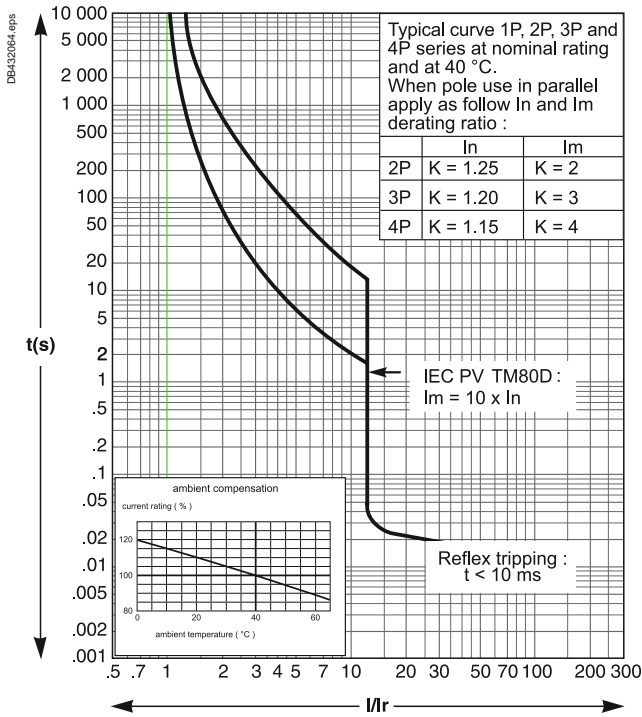

TM-DC PV 125

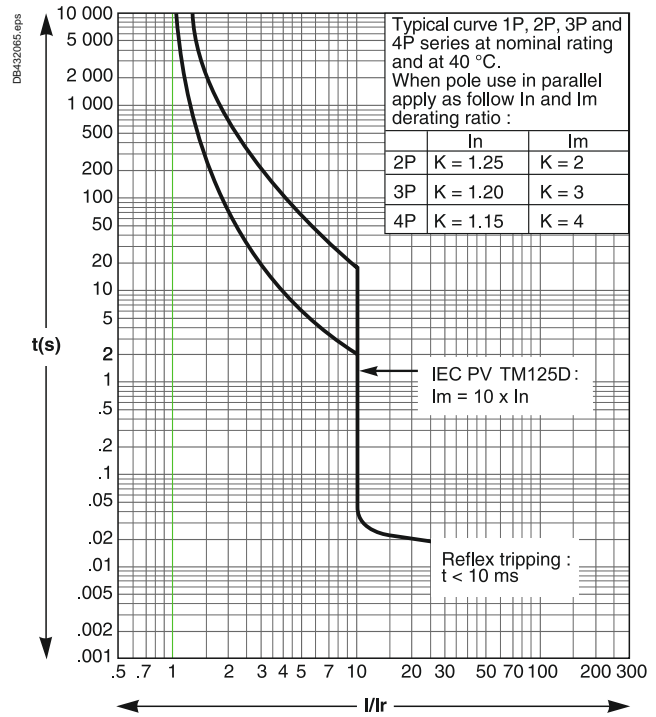

TM-DC PV 160

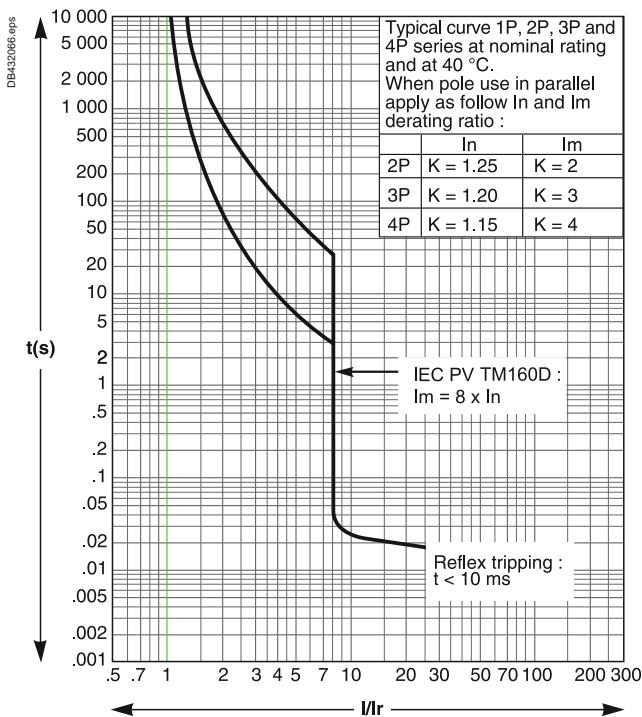

TM-DC PV 200

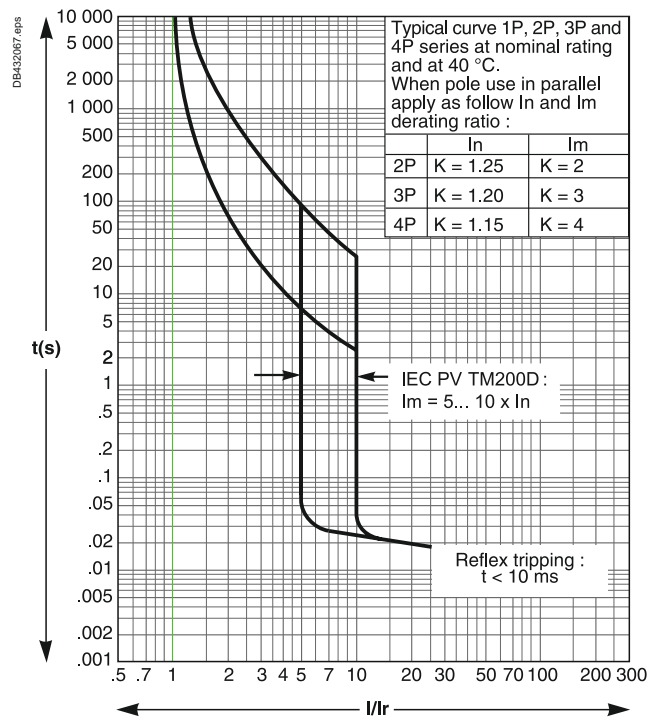

Compact NSX80 to 500 DC PV TM-DC PV magnetic trip units, tripping curves

TM-DC PV 250

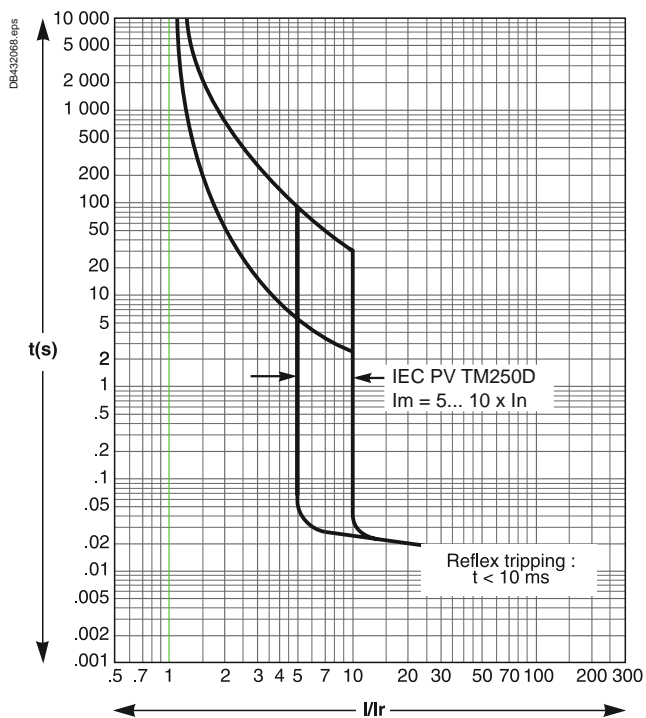

TM-DC PV 320/400

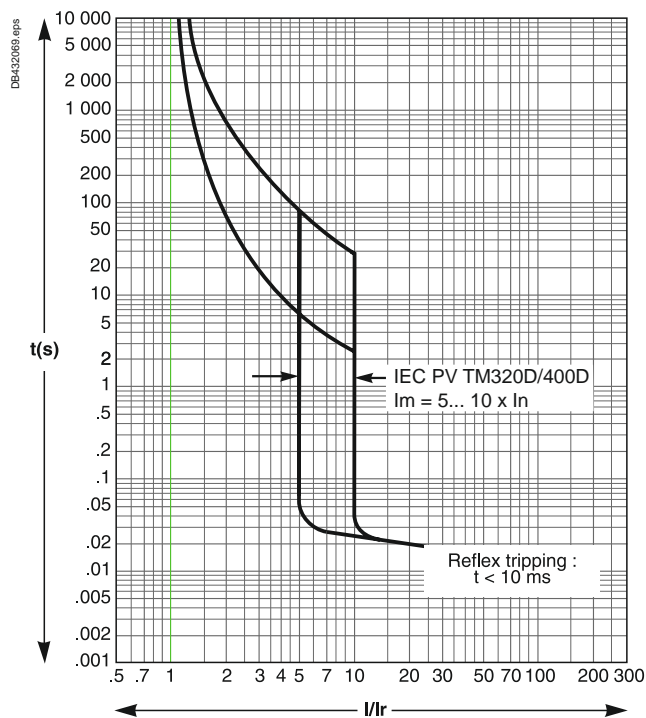

TM-DC PV 500

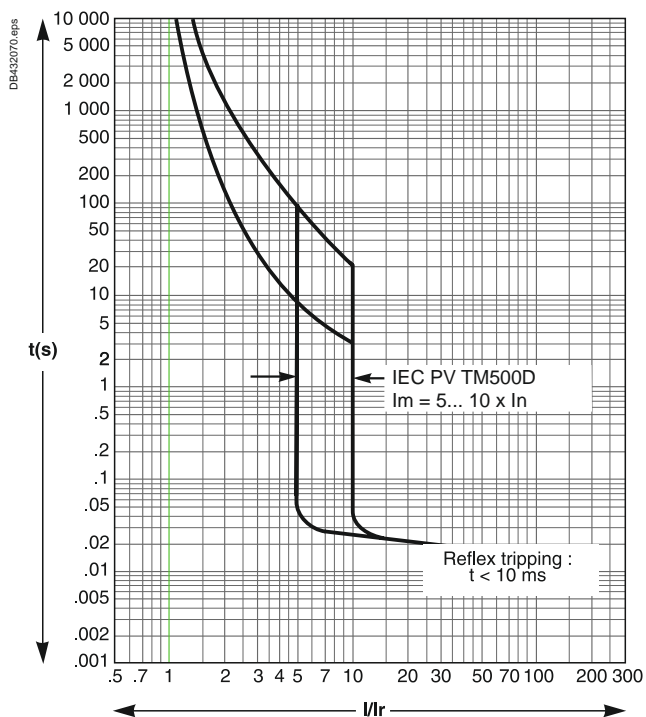

Additional characteristics

Masterpact NW10 to NW40 DC

Tripping curves

U = 500 V DC, L/R = 5 ms

Micrologic DC 1.0 instantaneous protection

With 1250 - 2500 A sensors

With 2500 - 5400 A sensors

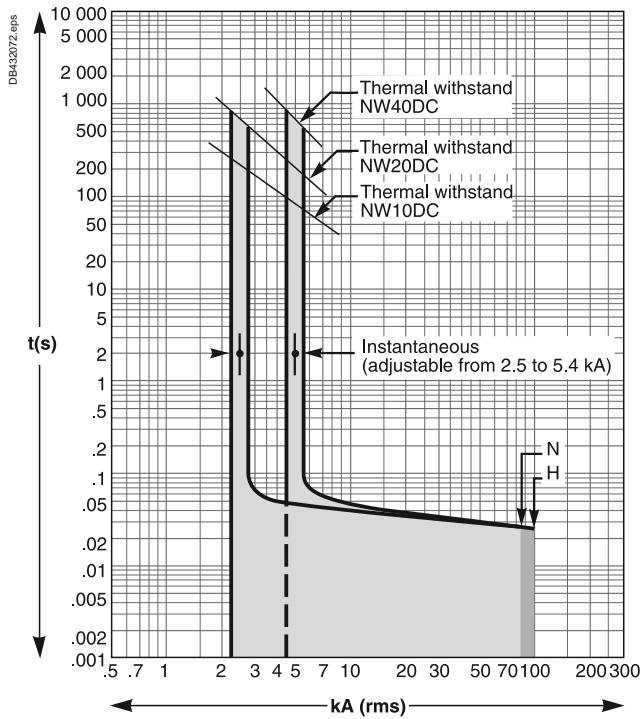
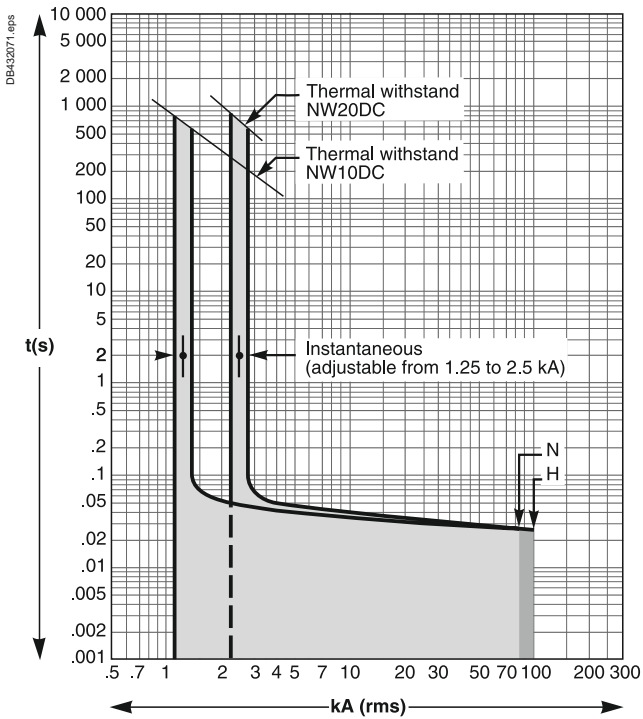

With 5000 - 11000 A sensors

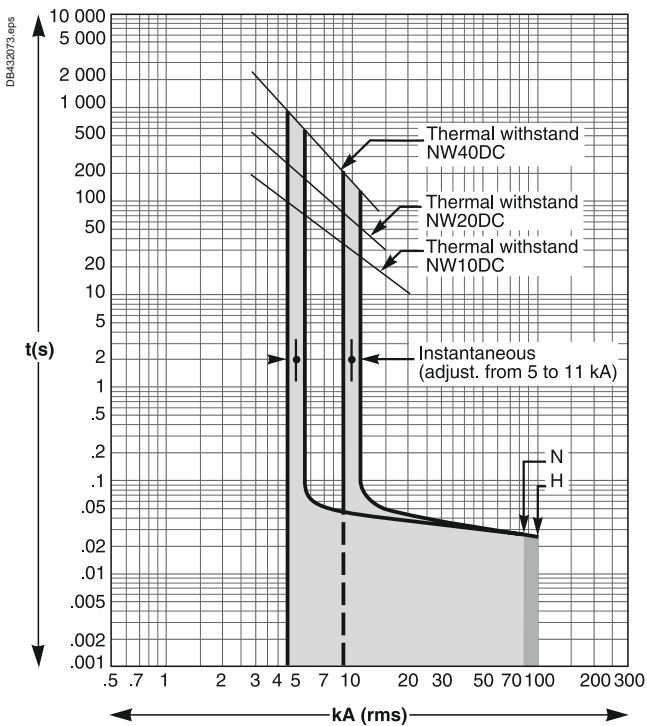

Masterpact NW10 to NW40 DC

Tripping curves

$U = 750/900 \text{ V DC}, L/R = 5 \text{ ms}$

Micrologic DC 1.0 instantaneous protection

With 1250 - 2500 A sensors

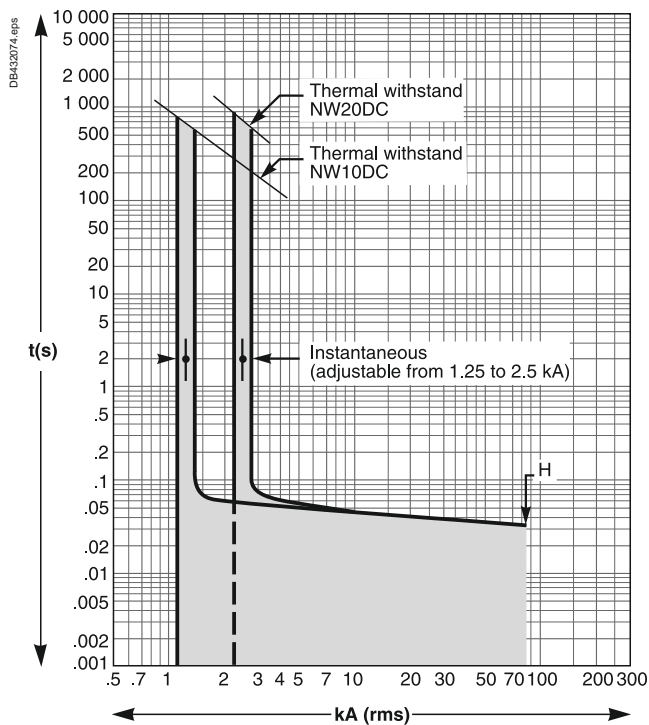

With 2500 - 5400 A sensors

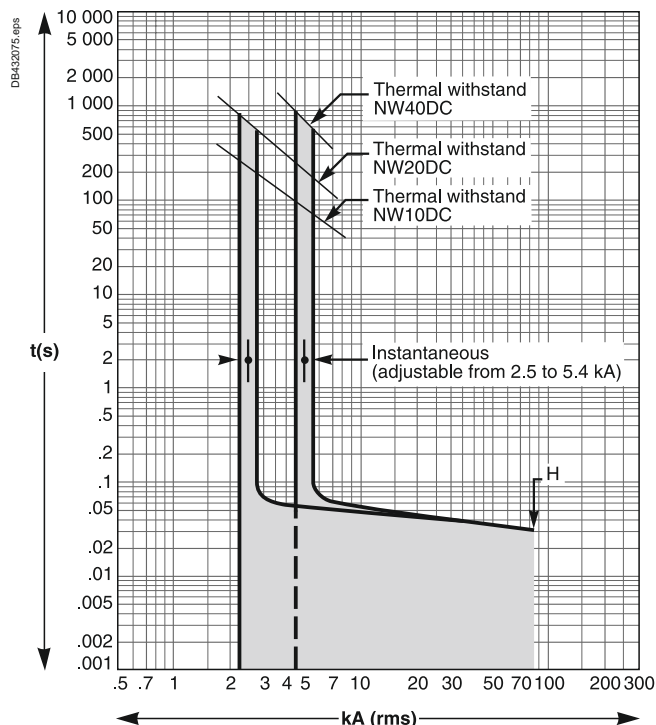

With 5000 - 11000 A sensors

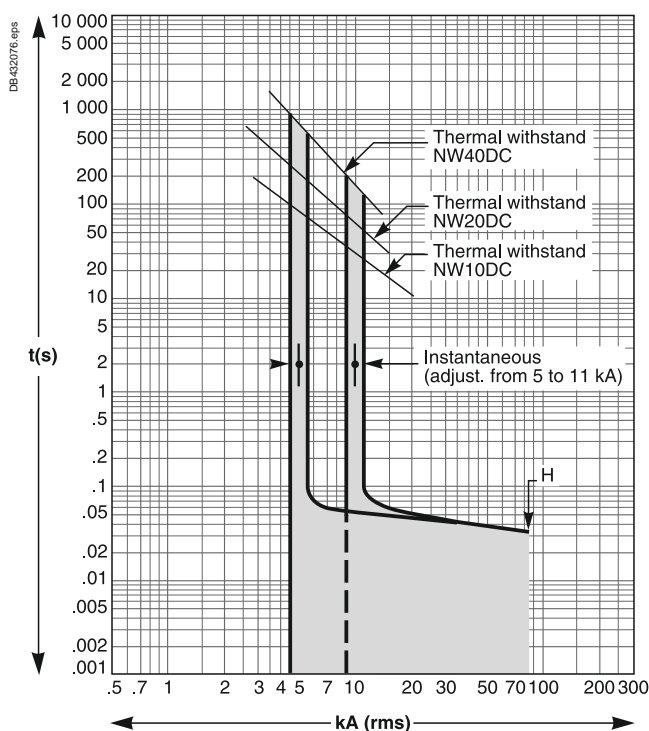

Additional characteristics

Masterpact NW10 to NW40 DC

Tripping curves

U = 500 V DC, L/R = 15 ms

Micrologic DC 1.0 instantaneous protection

With 1250 - 2500 A sensors

With 2500 - 5400 A sensors

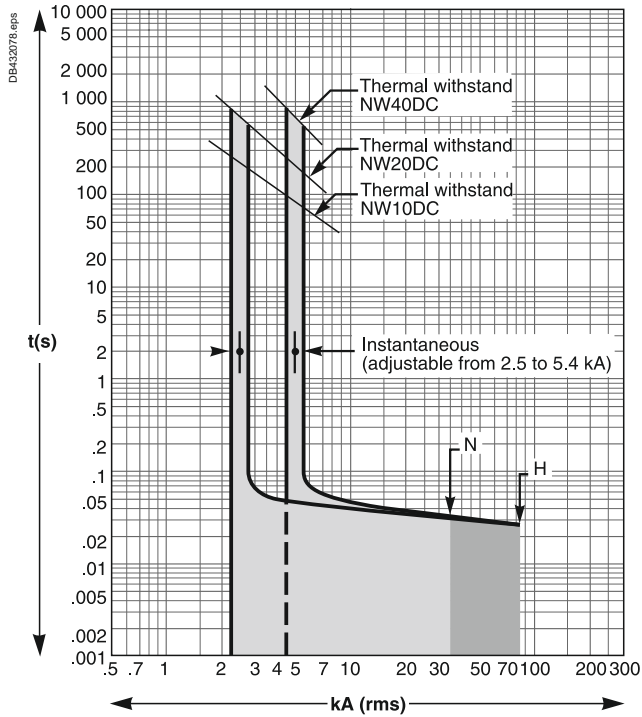
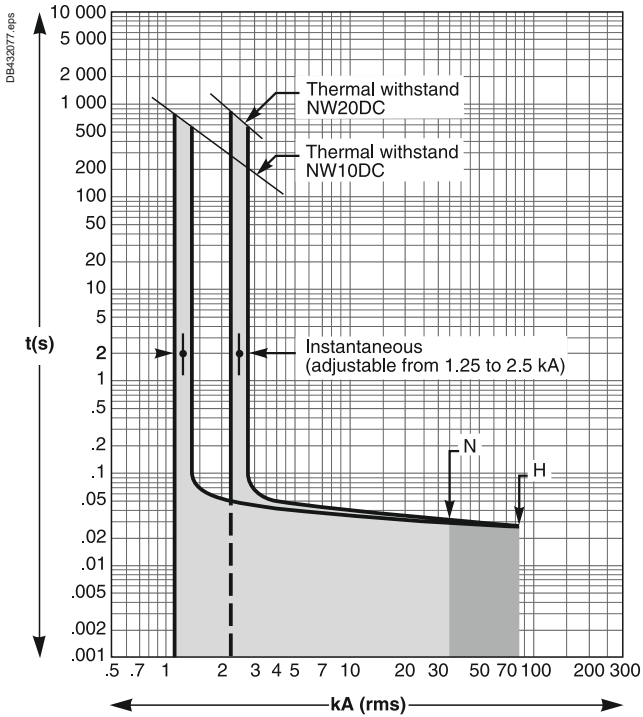

With 5000 - 11000 A sensors

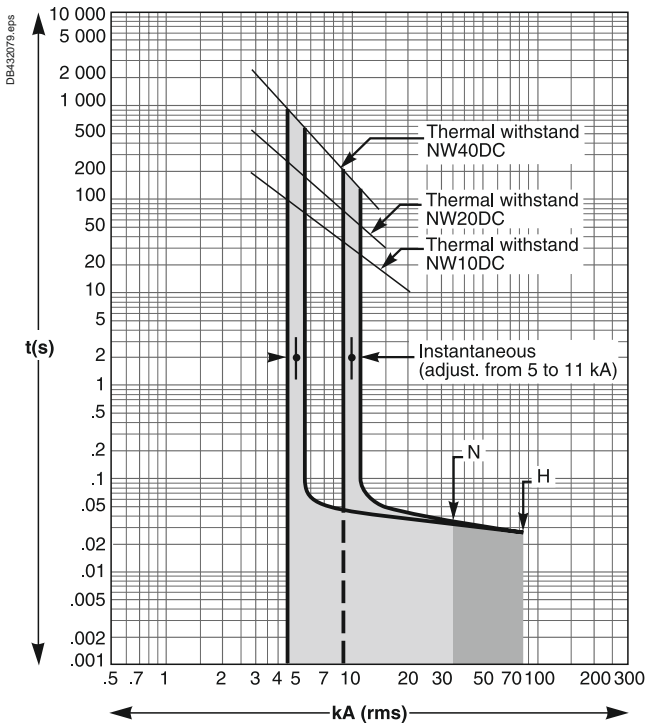

Masterpact NW10 to NW40 DC

Tripping curves

$U = 750/900 \text{ V DC}, L/R = 15 \text{ ms}$

Micrologic DC 1.0 instantaneous protection

With 1250 - 2500 A sensors

With 2500 - 5400 A sensors

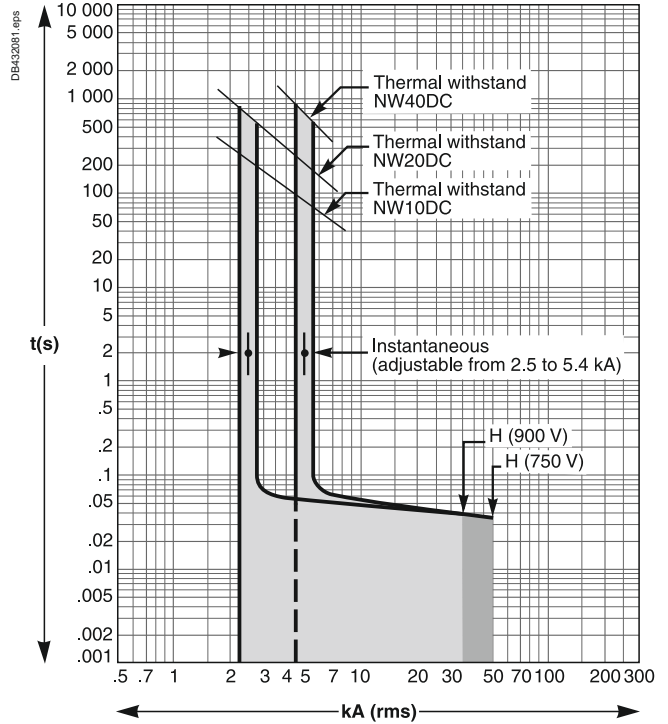
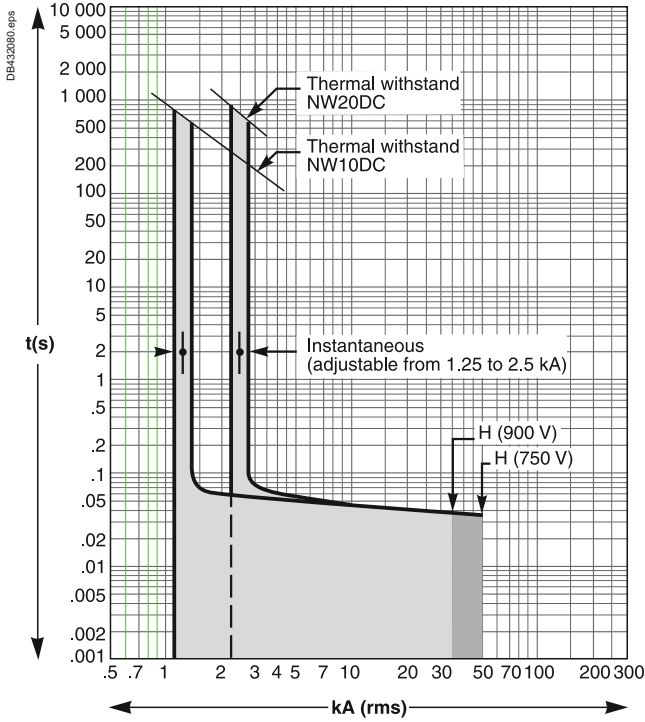

With 5000 - 11000 A sensors

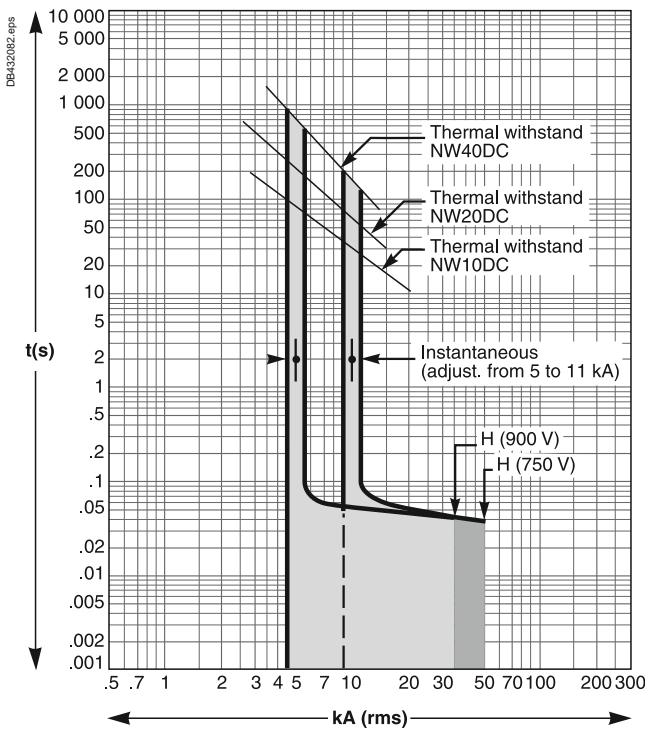

Masterpact NW10 to NW40 DC

Tripping curves

U = 500/750 V DC, L/R = 30 ms

Micrologic DC 1.0 instantaneous protection

With 1250 - 2500 A sensors

With 2500 - 5400 A sensors

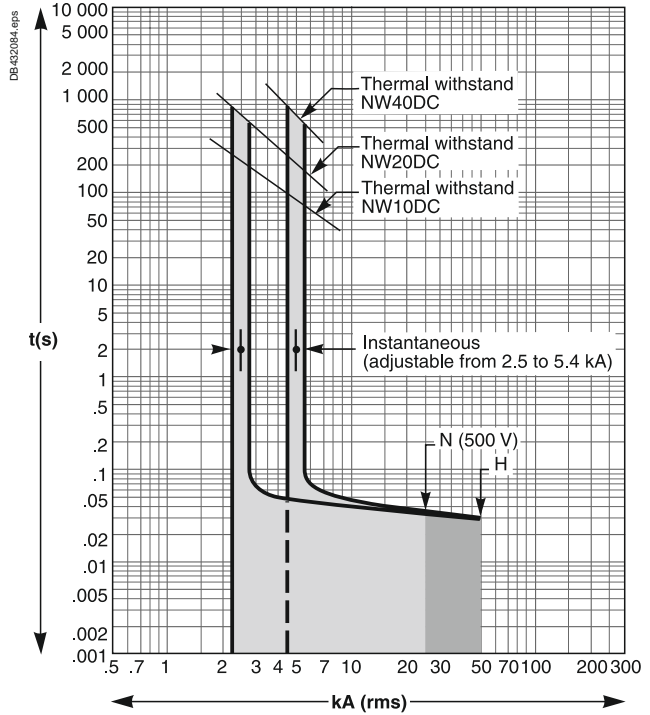
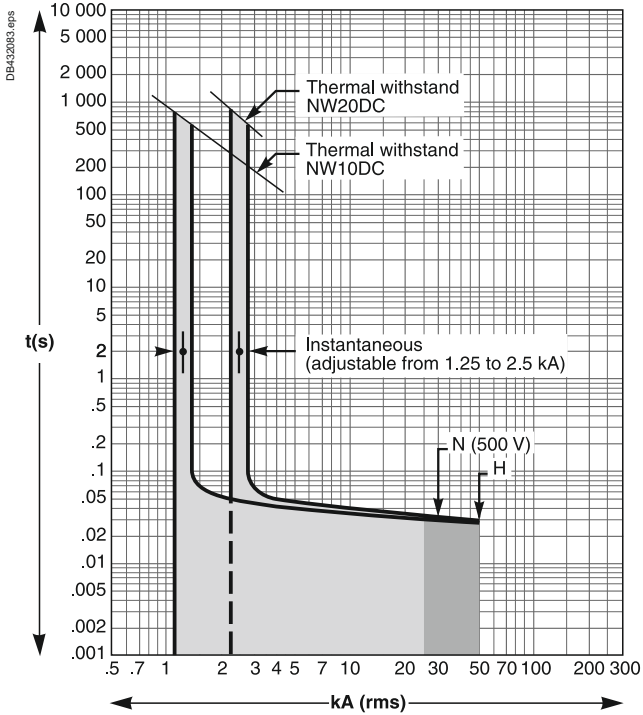

E

With 5000 - 11000 A sensors

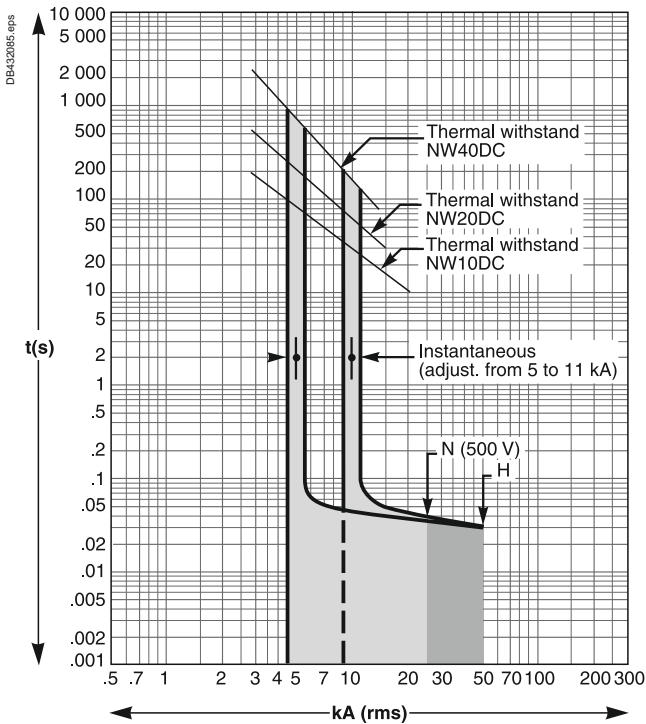

Masterpact NW10 to NW40 DC

Tripping curves

$U = 900 \text{ V DC}$, $L/R = 30 \text{ ms}$

Micrologic DC 1.0 instantaneous protection

With 1250 - 2500 A sensors

With 2500 - 5400 A sensors

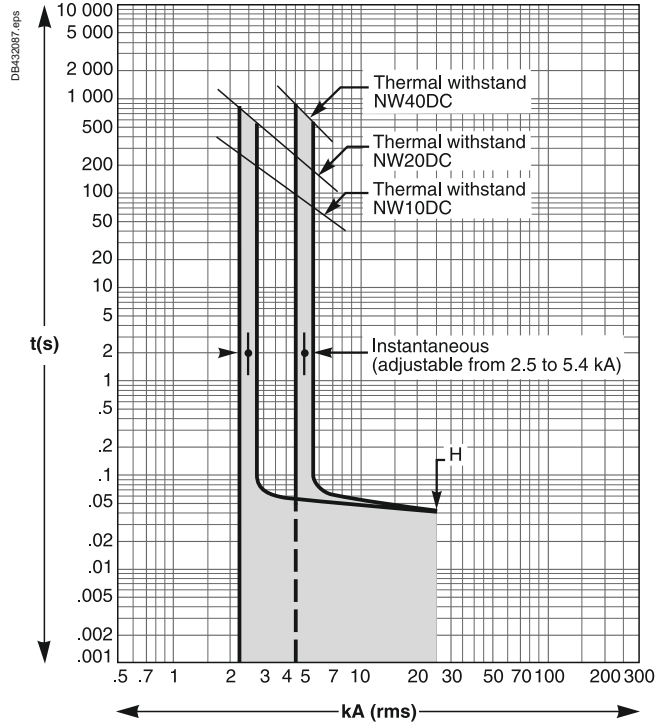
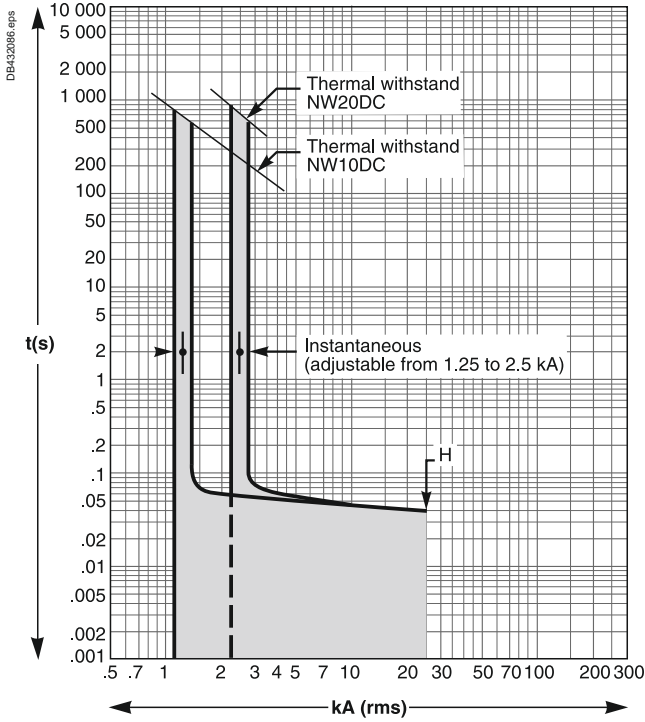

With 5000 - 11000 A sensors

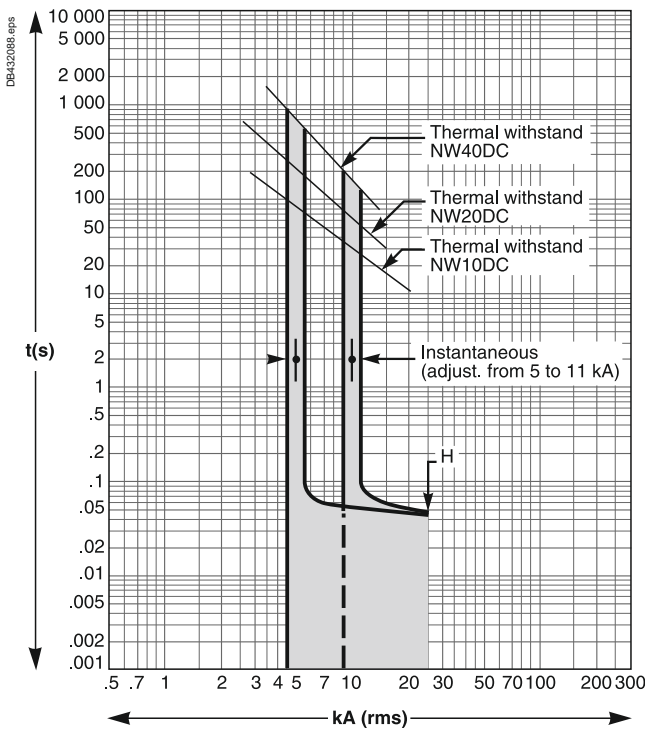



Catalogue numbers and order form

Compact NSX100 DC to NSX630 DC	
Choice of device.....	F-4
Compact NSX100 DC to 1200 DC, NSX400 NA DC to NSX630 NA DC	
Choice of device.....	F-5
Connection accessories.....	F-6
Electrical auxiliaries.....	F-8
Operation and locking/Interlocking.....	F-10
Installation.....	F-11
Compact NSX100 DC to NSX630 DC	
Plug-in/withdrawable accessories.....	F-12
Spare parts:	
Compact NSX100 DC to 1200 DC, NSX400 NA DC to NSX630 NA DC	F-13
Compact INS DC PV - Compact NSX80/500 TM DC PV to NSX100/500 NA DC PV	
Connection accessories.....	F-15
Electrical auxiliaries.....	F-17
Operation and locking/Interlocking.....	F-19
Installation.....	F-20
Compact NSX630b to 1600 NA DC PV fixed electrically operated	
Complete device without motor mechanism module.....	F-21
Device based on separate components with or without motor mechanism module.....	F-22
Compact INS40 to 160 DC	
Complete fixed/FC device and accessories.....	F-23
Accessories.....	F-24
Compact INS250-100 to 630 DC	
Complete fixed/FC device and accessories.....	F-26
Compact INV100 to 630 DC	
Complete fixed/FC device and specific accessories.....	F-27
Compact INS250-100 to 250 DC and Compact INV100 to 250 DC	
Accessories.....	F-28

Other chapters

Presentation.....	2
Functions and characteristics.....	A-1
Installation recommendations.....	B-1
Dimensions and connection.....	C-1
Electrical diagrams.....	D-1
Additional characteristics.....	E-1



Catalogue numbers and order form

Compact INS320 to 630 DC and Compact INV320 to 630 DC	
Accessories	F-31
Compact INS630b to 2500 DC	
Complete fixed/FC device and accessories	F-33
Complete fixed/FC device and specific accessories	F-34
Compact INS630b to 2500 DC and Compact INV630b to 2500 DC	F-35
Accessories	F-35
NW10 DC to NW40 DC fixed and drawout circuit breakers and switch-disconnectors	F-37
NW10 DC to NW40 DC fixed circuit breakers	
Indication contacts.....	F-38
Remote operation.....	F-39
NW10 DC to NW40 DC drawout circuit breakers	
Indication contacts.....	F-40
Chassis locking and accessories.....	F-41
Remote operation.....	F-42
Accessories for NW10 DC to NW40 DC fixed and drawout circuit breakers	F-43

F

Other chapters

Presentation	2
Functions and characteristics	A-1
Installation recommendations	B-1
Dimensions and connection	C-1
Electrical diagrams	D-1
Additional characteristics	E-1

Catalogue numbers and order form

Spare parts: Masterpact NW DC - DC PV

Connection.....	F-44
Remote operation.....	F-45
Chassis locking and accessories.....	F-46
Clusters.....	F-47
Circuit breaker locking and accessories.....	F-48
Mechanical interlocking for source changeover.....	F-49
Indication contacts.....	F-50
Instructions.....	F-51

Spare parts: Masterpact NW DC - DC PV

Monitoring and control converter.....	F-52
---------------------------------------	------

Compact NSX100 DC to NSX250 DC

circuit breakers.....	F-53
-----------------------	------

Compact NSX400 DC to NSX630 DC

Circuit breakers and switch-disconnectors.....	F-54
--	------

Compact NSX1200 DC circuit breakers.....

F-55

Compact NSX80/500 TM DC PV

to NSX100/500 NA DC PV

Circuit breakers and switch-disconnectors.....	F-56
--	------

Compact NSX630/1600 NA DC PV 4P, fixed version

Upside: front connection, 2 kit heatsink,

phase separator are included.....	F-57
-----------------------------------	------

Masterpact NW DC.....

F-58



Other chapters

Presentation.....	2
Functions and characteristics.....	A-1
Installation recommendations.....	B-1
Dimensions and connection.....	C-1
Electrical diagrams.....	D-1
Additional characteristics.....	E-1

Compact NSX100 DC to NSX630 DC

Choice of device

Compact NSX100/160 F/N/M/S 1P/2P

With thermal-magnetic trip unit TM-D

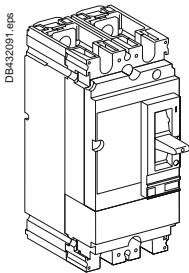
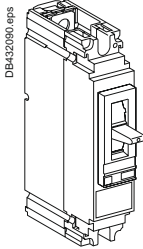

Compact NSX100F AC/DC

Rating	1P 1d (Icu = 36 kA 250 V DC)	2P 2d (Icu = 36 kA 250 V DC/1P - 500 V DC/2P)
TM16D	LV438562	LV438592
TM20D	LV438563	LV438593
TM25D	LV438564	LV438594
TM30D	LV438565	LV438595
TM40D	LV438566	LV438596
TM50D	LV438567	LV438597
TM63D	LV438568	LV438598
TM80D	LV438569	LV438599
TM100D	LV438570	LV438600

Compact NSX160F AC/DC

Rating	1P 1d (Icu = 36 kA 250 V DC)	2P 2d (Icu = 36 kA 250 V DC/1P - 500 V DC/2P)
TM125D	LV438669	LV438699
TM160D	LV438670	LV438700

Compact NSX100N AC/DC

Rating	1P 1d (Icu = 50 kA 250 V DC)	2P 2d (Icu = 85 kA 250 V DC/1P - 500 V DC/2P)
TM16D	LV438572	LV438602
TM20D	LV438573	LV438603
TM25D	LV438574	LV438604
TM30D	LV438575	LV438605
TM40D	LV438576	LV438606
TM50D	LV438577	LV438607
TM63D	LV438578	LV438608
TM80D	LV438579	LV438609
TM100D	LV438580	LV438610

Compact NSX160N AC/DC

Rating	1P 1d (Icu = 50 kA 250 V DC)	2P 2d (Icu = 85 kA 250 V DC/1P - 500 V DC/2P)
TM125D	LV438679	LV438709
TM160D	LV438680	LV438710

Compact NSX100M AC/DC

Rating	1P 1d (Icu = 85 kA 250 V DC)	2P 2d (Icu = 100 kA 250 V DC/1P - 500 V DC/2P)
TM16D	LV438582	LV438612
TM20D	LV438583	LV438613
TM25D	LV438584	LV438614
TM30D	LV438585	LV438615
TM40D	LV438586	LV438616
TM50D	LV438587	LV438617
TM63D	LV438588	LV438618
TM80D	LV438589	LV438619
TM100D	LV438590	LV438620

Compact NSX160M AC/DC

Rating	1P 1d (Icu = 85 kA 250 V DC)	2P 2d (Icu = 100 kA 250 V DC/1P - 500 V DC/2P)
TM125D	LV438689	LV438719
TM160D	LV438690	LV438720

F

Compact NSX100 DC to 1200 DC, NSX400 NA DC to NSX630 NA DC

Choice of device

Compact NSX100/160/250 DC

Basic frame

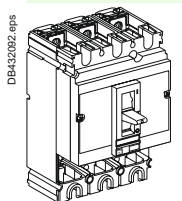

	3P	4P
Rating	(Icu = 36 kA 250 V DC/1P - 500 V DC/ 2P - 750 V DC/3P)	
NSX100F DC	LV438003	LV438008
NSX160F DC	LV438103	LV438108
NSX250F DC	LV438203	LV438208
	(Icu = 100 kA 250 V DC/1P - 500 V DC/ 2P - 750 V DC/3P)	
NSX100S DC	LV438018	LV438019
NSX160S DC	LV438118	LV438119
NSX250S DC	LV438218	LV438219

+ Trip unit

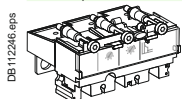

	3P 3d	4P 4d
Standard protection: trip unit TM-D/DC		
Rating		
TM16D	LV429037	LV429057
TM25D	LV429036	LV429056
TM32D	LV429035	LV429055
TM40D	LV429034	LV429054
TM50D	LV429033	LV429053
TM63D	LV429032	LV429052
TM80DC	LV438029	LV438049
TM100DC	LV438028	LV438048
TM125DC	LV438136	LV438146
TM160DC	LV438135	LV438145
TM200DC	LV438246	LV438256
TM250DC	LV438245	LV438255
Type G protection: trip unit TM-G		
Rating		
TM16G	LV429155	LV429165
TM25G	LV429154	LV429164
TM40G	LV429153	LV429163
TM63G	LV429152	LV429162
TM80G	LV430080	LV430092
TM100G	LV430081	LV430093
TM125G [*]	LV430082	LV430094
TM160G [*]	LV430083	LV430095
TM200G [*]	LV430084	LV430096
TM250G [*]	LV430085	LV430097

Compact NSX250/630 F/S DC

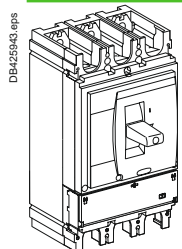

	3P	4P
Rating	(Icu = 36 kA 250 V DC/1P - 500 V DC/ 2P - 750 V DC/3P)	
NSX250F TM-DC	LV438265	LV438260
NSX320F TM-DC	LV438266	LV438261
NSX400F TM-DC	LV438267	LV438262
NSX500F TM-DC	LV438268	LV438263
	(Icu = 36 kA 250 V DC/1P - 500 V DC/ 2P)	
NSX600F TM-DC	LV438269	LV438264
	(Icu = 100 kA 250 V DC/1P - 500 V DC/ 2P - 750 V DC/3P)	
NSX250S TM-DC	LV438275	LV438270
NSX320S TM-DC	LV438276	LV438271
NSX400S TM-DC	LV438277	LV438272
NSX500S TM-DC	LV438278	LV438273
	(Icu = 100 kA 250 V DC/1P - 500 V DC/ 2P)	
NSX600S TM-DC	LV438279	LV438274

Compact NSX630/1200 DC

Rating	2P (Icu = 50 kA 300 V DC/ 1P - 600 V DC/2P)	
	without bare cable connector	with bare cable connector
NSX630 TM-DC	LV438545	LV438549
NSX800 TM-DC	LV438546	LV438550
NSX1000 TM-DC	LV438547	LV438551
NSX1200 TM-DC	LV438548	LV438552

Compact NSX100/160/250 NA [1]

With NA switch-disconnector unit

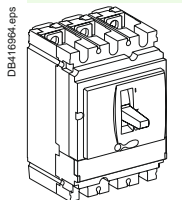

Compact NSX100NA			
Rating	2P	3P	4P
100	LV429619	LV429629	LV429639
Compact NSX160NA			
Rating	2P	3P	4P
160	LV430619	LV430629	LV430639
Compact NSX250NA			
Rating	2P	3P	4P
250	LV431619	LV431629	LV431639

Compact NSX400/630 NA DC

	3P	4P
Compact NSX400 NA DC	LV438153	LV438151
Compact NSX630 NA DC	LV438154	LV438152

[1] See catalogue Compact NSX LVPED208001EN for order form and configured product.



[*] Adapted products (basic frame and trip unit TMG are not sold separately).



Compact NSX100 DC to 1200 DC, NSX400 NA DC to NSX630 NA DC

Connection accessories

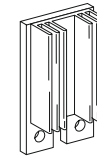
Special connection accessories for parallel or series connection

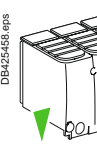
			NSX100-250 DC	NSX400-630 DC	NSX1200 DC
	Connection accessories				
	Connection accessories for parallel or series connection of 2 poles ^[1]	1 connection plate equipped with heat sink + 1 interphase barrier ^[2]	LV438328	LV438338	
	Connection plates				
	Connection plates for parallel connection of 3 poles	1 set of 2 connection plates	LV438329 ^[3]	^[3]	
	Connection plates for parallel connection of 4 poles			^[3]	
	1P short terminal shields	1 pair	LV438320		
	2P short terminal shields	2 pairs	2 x LV438320		
	3P terminal shields for series connection of poles	1 set	LV438325	LV438291 ^[5]	
				LV438292 ^[5]	
				LV438294 ^[5]	
	4P terminal shields for series connection of poles	1 set	LV438326	LV438294 ^[5]	
				LV438295 ^[5]	
	4P terminal shields for parallel connection of poles (2P/4P)	1 set	LV438327	LV438293 ^[5]	LV438293 ^[5]
	1 long terminal shield for breaker or plug-in base	3P	LV429517		
		4P	LV429518		

Connection accessories (Cu or Al)

NSX100-250 DC

NSX400-630 DC

			NSX100-250 DC	NSX400-630 DC
Rear connections				
	2 short		LV429235	LV432475
	2 long		LV429236	LV432476
Bare cable connectors				
	Steel connectors	1.5 to 95 mm ² ; ≤ 160 A	Set of 2	LV429246
			Set of 3	LV429242
			Set of 4	LV429243
	Aluminium connectors	25 to 95 mm ² ; ≤ 250 A	Set of 2	LV429255
			Set of 3	LV429227
			Set of 4	LV429228
			Set of 2	LV429247
		120 to 185 mm ² ; ≤ 250 A	Set of 3	LV429259
			Set of 4	LV429260
			Set of 10	LV429241
	Clips for connectors			
	Aluminium connectors for 2 cables ^[4] 2 x (50 to 120 mm ²) ; ≤ 250 A		Set of 3 (3P)	LV429218
			Set of 4 (4P)	LV429219
	Aluminium connectors 1x (35 to 300 mm ²)		Set of 3 (3P)	LV432479
			Set of 4 (4P)	LV432480
	Aluminium connectors ^[4] for 6 cables 6 x (1.5 to 35 mm ²) ; ≤ 250 A		Set of 3 (3P)	LV429248
			Set of 4 (4P)	LV429249
	Aluminium connectors for 2 cables 2 x (35 to 300 mm ²)		Set of 3 (3P)	LV432481
			Set of 4 (4P)	LV432482
	6.35 mm voltage tap for steel or aluminium connectors		Set of 10	LV429348

[1] Series connection: 2 poles = 1 connection plate.
 3 poles = 2 connection plates.
 4 poles = 3 connection plates.
 Parallel connection: 2 poles = 2 connection plates.
 3 poles = 1 set of 2 connection plates (29499).
 2 x 2 poles = 4 connection plates.

[2] These connection accessories come with an interphase barrier.

[3] To be made by the customer.

[4] Supplied with 2 or 3 interphase barriers.

[5] Refer to page B-5 for details.

Compact NSX100 DC to 1200 DC, NSX400 NA DC to NSX630 NA DC

Connection accessories (cont.)

Connection accessories (Cu or Al)

	NSX100-250 DC	NSX400-630 DC	NSX1200 DC
--	---------------	---------------	------------

Terminal extensions

 DB43204.eps	Right-angle terminal extensions	Set of 2 Set of 3 Set of 4	LV429250 LV429261 LV429262	LV432484 LV432485		
	 DB43205.eps	Straight terminal extensions	Set of 2 Set of 3 Set of 4	LV429251 LV429263 LV429264		
		 DB112230.eps	45° terminal extension ^[1]	Set of 3 Set of 4	LV429223 LV429224	
 DB112231.eps			Edgewise terminal extensions ^[1]	Set of 3 Set of 4	LV429308 LV429309	LV432486 LV432487
	 DB112234.eps	Double-L terminal extensions ^[1]	Set of 3 Set of 4	LV429221 LV429222		
 DB112235.eps		Spreaders from 35 to 45 mm pitch ^[1]	3P 4P	LV431563 LV431564		
	 DB112236.eps	One-piece spreader from 35 to 45 mm pitch	3P 4P	LV431060 LV431061		
		Front alignment base (for one-piece spreader)	3P/4P	LV431064		

Crimp lugs for copper cable (supplied with 2 or 3 interphase barriers)

 DB112237.eps	For cable 120 mm ²	Set of 3 Set of 4	LV429252 LV429256		
	For cable 150 mm ²	Set of 3	LV429253		
		Set of 4	LV429257		
	For cable 185 mm ²	Set of 3	LV429254	LV429254	LV429254
		Set of 4	LV429258	LV429258	LV429258
	For cable 240 mm ²	Set of 3		LV432500	LV432500
Set of 4			LV432501	LV432501	
For cable 300 mm ²	Set of 3		LV432502	LV432502	
	Set of 4		LV432503	LV432503	

Crimp lugs for aluminium cable (supplied with 2 or 3 interphase barriers)

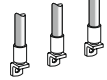
 DB112238.eps	For cable 150 mm ²	Set of 3 Set of 4	LV429504 LV429505		
	For cable 185 mm ²	Set of 3	LV429506	LV429506	LV429506
		Set of 4	LV429507	LV429507	LV429507
	For cable 240 mm ²	Set of 3		LV432504	LV432504
Set of 4			LV432505	LV432505	
For cable 300 mm ²	Set of 3		LV432506	LV432506	
	Set of 4		LV432507	LV432507	

Barriers

 DB43206.eps	Interphase barriers	Set of 6	LV429329	LV432570	
--	---------------------	----------	----------	----------	--

Insulation screen

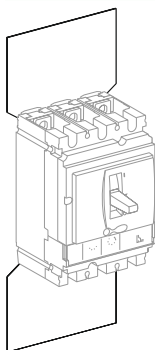
 DB112242.eps	2 insulating screens for breaker (45 mm pitch)	3P	LV429330			
		4P	LV429331			
	2 insulating screens for breaker (70 mm pitch)	3P			LV432578	
		4P			LV432579	

[1] Supplied with 2 or 3 interphase barriers.

Compact NSX100 DC to 1200 DC, NSX400 NA DC to NSX630 NA DC

Electrical auxiliaries

Electrical auxiliaries

Auxiliary contacts (changeover)



DB112254.eps 	OF or SD or SDE or SDV		29450	
	OF or SD or SDE or SDV low level		29452	
	SDE adapter, mandatory for trip unit		LV429451	
Voltage releases		MX	MN	
DB111454.eps 	AC	24 V 50/60 Hz	LV429384	LV429404
		48 V 50/60 Hz	LV429385	LV429405
		110-130 V 50/60 Hz	LV429386	LV429406
		220-240 V 50/60 Hz 208-277 V 60 Hz	LV429387	LV429407
		380-415 V 50 Hz 440-480 V 60 Hz	LV429388	LV429408
	DC	525 V 50 Hz - 600 V 60 Hz	LV429389	LV429409
		12 V	LV429382	LV429402
		24 V	LV429390	LV429410
		30 V	LV429391	LV429411
		48 V	LV429392	LV429412
MN 48 V 50/60 Hz with fixed time delay	60 V	LV429383	LV429403	
	125 V	LV429393	LV429413	
250 V	LV429394	LV429414		
	MN 48 V 50/60 Hz with fixed time delay			
Composed of:	MN 48 V DC		LV429412	
	Delay unit 48 V 50/60 Hz		LV429426	
MN 220-240 V 50/60 Hz with fixed time delay				
Composed of:	MN 250 V DC		LV429414	
	Delay unit of 220-240 V 50/60 Hz		LV429427	
MN 48 V DC/AC 50/60 Hz with adjustable time delay				
Composed of:	MN 48 V DC		LV429412	
	Delay unit 48 V DC/AC 50/60 Hz		33680	
MN 110-130 V DC/AC 50/60 Hz with adjustable time delay				
Composed of:	MN 125 V DC		LV429413	
	Delay unit 100-130 V DC/AC 50/60 Hz		33681	
MN 220-250 V DC/AC 50/60 Hz with adjustable time delay				
Composed of:	MN 250 V DC		LV429414	
	Delay unit 200-250 V DC/AC 50/60 Hz		33682	

Motor mechanism

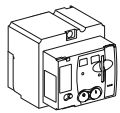
Motor mechanism module supplied with SDE adapter

DB125354.eps 	AC	Voltage	MT100/160	MT250	MT400-630
		48-60 V 50/60 Hz	LV429440	LV431548	LV432639
	DC	110-130 V 50/60 Hz	LV429433	LV431540	LV432640
		220-240 V 50/60 Hz	LV429434	LV431541	LV432641
		208-277 V 60 Hz			
		380-415 V 50/60 Hz	LV429435	LV431542	LV432642
		440-480 V 60 Hz			LV432647
		24-30 V	LV429436	LV431543	LV432643
		48-60 V	LV429437	LV431544	LV432644
		110-130 V	LV429438	LV431545	LV432645
250 V	LV429439	LV431546	LV432646		
Operations counter			LV432648		

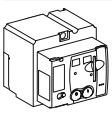
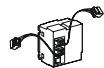
Communicating motor mechanism module supplied with SDE adapter

DB112265.eps   	Motor mechanism module	MTc 100/160	220-240 V 50/60 Hz	LV429441
		MTc 250	220-240 V 50/60 Hz	LV431549
		MTc 400/630	220-240 V 50/60 Hz	LV432652
	+ Breaker and Status Communication Module	BSCM		LV434205
	+ NSX cord	Wire length L = 0.35 m		LV434200
		Wire length L = 1.3 m		LV434201
		Wire length L = 3 m		LV434202
		U > 480 V AC wire length L = 0.35 m		LV434204



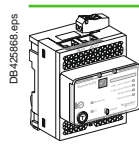
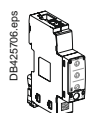
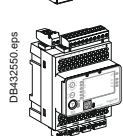

Compact NSX100 DC to 1200 DC, NSX400 NA DC to NSX630 NA DC

Electrical auxiliaries

Communication option

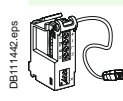
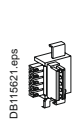
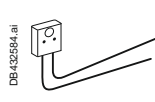
	IFE	Ethernet interface for LV breaker	LV434001
		Ethernet interface for LV breakers and gateway	LV434002
	IFM Modbus-SL interface module		LV434000
	I/O application module		LV434063
	User guide IFE		DOCA0084EN
	User guide I/O application module		DOCA0055EN

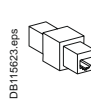
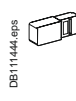
ULP wiring accessories

	NSX cord L = 0.35 m		LV434200
	NSX cord L = 1.3 m		LV434201
	NSX cord L = 3 m		LV434202
	NSX cord for U > 480 V AC L = 1.3 m		LV434204
	10 stacking connectors for communication interface modules		TRV00217
	2 Modbus line terminators		VW3A8306DRC ^[1]
	RS 485 roll cable (4 wires, length 60 m)		50965
	5 RJ45 connectors female/female		TRV00870
	10 ULP line terminators		TRV00880
	10 RJ45/RJ45 male cord L = 0.3 m		TRV00803
	10 RJ45/RJ45 male cord L = 0.6 m		TRV00806
	5 RJ45/RJ45 male cord L = 1 m		TRV00810
	5 RJ45/RJ45 male cord L = 2 m		TRV00820
	5 RJ45/RJ45 male cord L = 3 m		TRV00830
	1 RJ45/RJ45 male cord L = 5 m		TRV00850
	2 wires RS 485 insulated repeated		TRV00211

Power supply modules

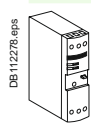
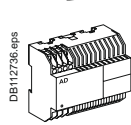
	External power supply module 100-240 V AC 110-230 V DC / 24 V DC-3 A class 2		ABL8RPS24030 ^[2]
	External power supply module 24 V DC-1 A OVC IV		
	24-30 V DC		54440
	48-60 V DC		54441
	100-125 V AC		54442
	110-130 V AC		54443
	200-240 V AC		54444
380-415 V AC		54445	



[1] SDE adapter mandatory for trip unit TM, TMG.

[2] www.schneider-electric.com.

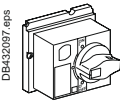
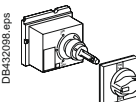

Compact NSX100 DC to 1200 DC, NSX400 NA DC to NSX630 NA DC

Operation and locking/Interlocking

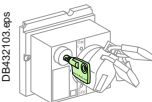
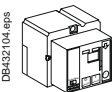
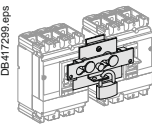
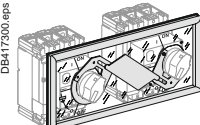
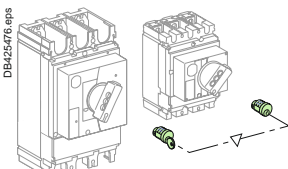
Rotary handles		NSX100-250 DC	NSX400-1200 DC	
Direct rotary handles				
	With black handle	LV429337	LV432597	
	With red handle on yellow front	LV429339	LV432599	
	MCC conversion accessory	LV429341	LV432606	
	CNOMO conversion accessory	LV429342	LV432602	
Extended rotary handle				
	With black handle	LV429338	LV432598	
	With red handle on yellow front	LV429340	LV432600	
	With telescopic handle for withdrawable device	LV429343	LV432603	
Accessories				
	Indication auxiliary	1 early-break contact	LV429345	LV432605
		2 early-break contacts	LV429346	LV429346
Locks		NSX100-250 DC	NSX400-1200 DC	
Toggle locking device for 1 to 3 padlocks				
	By removable device	29370	29370	
	By fixed device for 3P/4P (open or close position)	LV429371	LV432631	
	By fixed device for 3P/4P (open position only)	LV429370	LV432630	
Locking of the rotary handle				
	Keylock adapter (keylock not included)	LV429344	LV432604	
	Keylock (keylock adapter not included)	Ronis 1351B.500	41940	
		Profalux KS5 B24 D4Z	42888	
Locking of the motor mechanism modules				
	Keylock adapter + Ronis keylock (special)	LV429449	LV432649	
	Keylock (keylock adapter not included)	Ronis 1351B.500	41940	
		Profalux KS5 B24 D4Z	42888	
Interlocking		NSX100-250 DC	NSX400-1200 DC	
Mechanical interlocking for circuit breakers				
	With toggles	LV429354	LV432614	
	With rotary handles	LV429369	LV432621	
Interlocking with key (2 keylocks / 1 key) for rotary handles				
	Keylock kit (keylock not included) ^[1]	LV429344	LV432604	
	1 set of 2 keylocks	Ronis 1351B.500	41950	
	(1 key only, keylock kit not included)	Profalux KS5 B24 D4Z	42878	

[1] NSX100-250 DC only.

Compact NSX100 DC to 1200 DC, NSX400 NA DC to NSX630 NA DC Installation

Installation accessories

NSX100-250 DC | NSX400-1200 DC

Front-panel escutcheons

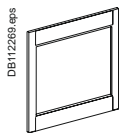

IP30

IP30 escutcheon for all control types	LV429525	LV432557
IP30 trip unit access escutcheon for toggle	LV429526	LV432559

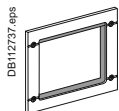

IP40

IP40 escutcheon for all control types	LV429317	LV432558
---------------------------------------	----------	----------

IP43 rubber toggle cover



1 toggle cover	LV429319	LV432560
----------------	----------	----------

Lead-sealing accessories



Bag of accessories	LV429375	LV429375
--------------------	----------	----------

Din rail adapter

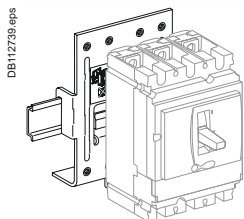

1 adapter	LV429305	
-----------	----------	--

60 mm plate busbar adapter



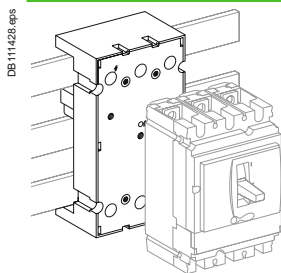





NSX100-250 DC | NSX400-630 DC

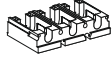

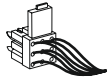
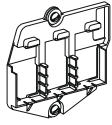
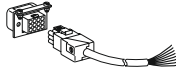
3P 60 mm busbar adapter	LV429372	LV432623
4P 60 mm busbar adapter	LV429373	LV432624

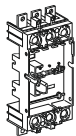
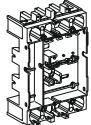

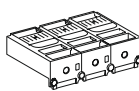
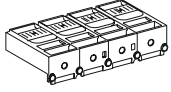



Compact NSX100 DC to NSX630 DC Plug-in/withdrawable accessories

Plug-in/withdrawable version accessories		NSX100-250 DC	NSX400-630 DC	
Insulation accessories				
	1 connection adapter for plug-in base	3P	LV429306	LV432584
		4P	LV429307	LV432585
Auxiliary connections				
	1 9-wire fixed connector (for base)		LV429273	LV429273
	1 9-wire moving connector (for circuit breaker)		LV429274	LV432523
	1 support for 2 moving connectors		LV429275	LV432525
	9-wire manual auxiliary connector (fixed + moving)		LV429272	LV429272
Plug-in base accessories				
	2 long insulated right angle terminal extensions	Set of 2	LV429276	LV432526
	2 IP40 shutters for base		LV429271	LV432521
	Base	2P	LV429265	
		3P	LV429266	LV432516
	Base	4P	LV429267	LV432517
	2 power connections	2/3/4P	LV429268	LV432518
	1 short terminal shields	2/3P	LV429515	LV432591
	1 short terminal shields	4P	LV429516	LV432592
	1 safety trip interlock	2/3/4P	LV429270	LV432520
Installation and connection				
	Kit for Compact	3P	LV429289 + LV429282 + LV429283	LV432538 + LV432532 + LV432533
		4P	LV429290 + LV429282 + LV429283	LV432539 + LV432532 + LV432533

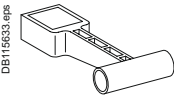
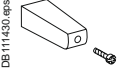
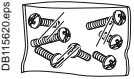
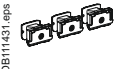
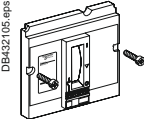
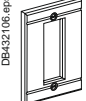
F

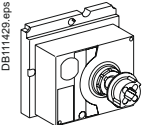
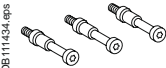
Spare parts: Compact NSX100 DC to 1200 DC, NSX400 NA DC to NSX630 NA DC

Spare parts		NSX100-250 DC	NSX400-1200 DC
 DB115630.eps	Additional toggle extension		32595
 DB111430.eps	10 spare toggle extensions (only for Compact NSX250)	LV429313	
	5 spare toggle extensions		LV432553
 DB115620.eps	Bag of screws	LV429312	LV432552
 DB111431.eps	12 snap-in nuts (fixed/FC)	M6 for NSX100N/H/L M8 for NSX160/250N/H/L	LV429234 LV430554
 DB432105.eps	NS retrofit escutcheon	Small cut-out	LV429528 LV432571
 DB432106.eps	IP40 toggle escutcheon	Compact NS type/small cut-out	29315 32556
 DB111438.eps	1 set of 10 identification labels		LV429226 LV429226
 DB111429.eps	1 base for extended rotary handle		LV429502 LV432498
 DB111434.eps	Torque limiting screws (set of 12)	3P/4P Compact NSX100-630	LV429513 LV432513
 DB111436.eps	5 transparent covers for trip unit	TM, MA, NA	LV429481



Compact INS DC PV - Compact NSX80/500 TM DC PV to NSX100/500 NA DC PV

Compact INS DC PV - 1 [1]

 <p style="font-size: 8px; transform: rotate(-90deg); position: absolute; left: -40px; top: 50px;">DB417876.eps</p>	Compact INS PV - 1 4P	28907
--	-----------------------	--------------

Compact NSX TM DC PV 4P circuit breaker

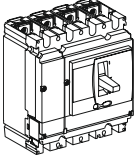
		Connection and insulation accessories mandatory				
		Upstream connection (x2)		Upstream terminal shields		Downstream terminal shields
 <p style="font-size: 8px; transform: rotate(-90deg); position: absolute; left: -40px; top: 50px;">DB415726.eps</p>	NSX80 LV438081 NSX125 LV438126 NSX160 LV438161 NSX200 LV438201 NSX250 LV438451 NSX320 LV438452 NSX400 LV438453 NSX500 LV438454	connection plate with heatsink	LV438328 LV438328 LV438328 LV438328 LV438338 LV438338 LV438338 LV438338	LV438327 LV438327 LV438327 LV438327 LV438293 LV438293 LV438293 LV438293	LV429518 LV429518 LV429518 LV429518 LV432594 LV432594 LV432594 LV432594	LV429518 LV429518 LV429518 LV429518 LV432594 LV432594 LV432594 LV432594

Compact NSX NA DC PV 4P switch disconnecter

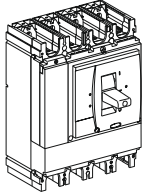
		Connection and insulation accessories mandatory					
		Upstream connection (x2)		Upstream terminal shields	or interphase barrier	Downstream terminal shields	or interphase barrier
 <p style="font-size: 8px; transform: rotate(-90deg); position: absolute; left: -40px; top: 50px;">DB415727.eps</p>	NSX100 LV438100 NSX160 LV438160 NSX200 LV438250 (≤ 200 A at 40 °C) NSX200 LV438250 (= 200 A at 55 °C) NSX400 LV438300 NSX500 LV438500	connection plate with heatsink connection plate with heatsink (long)	LV438328 LV438328 LV438328 LV438339 LV438338 LV438338	LV438327 LV438327 LV438327 not available LV438337 LV438337	LV429329 LV429329 LV429329 LV429329 LV432570 LV432570	LV429518 LV429518 LV429518 LV429518 LV432594 LV432594	LV429329 LV429329 LV429329 LV429329 LV432570 LV432570

[1] For accessories, see catalogue INS/INV page dedicated to INS40 to 160 A.







Compact NSX80/500 TM DC PV to NSX100/500 NA DC PV

Connection accessories

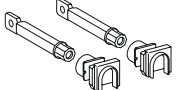
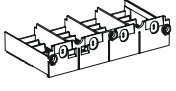
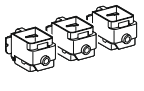
Connection accessories (Cu or Al)

NSX100-250
DC PV

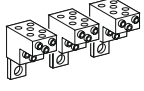
NSX400-630
DC PV

Rear connections					
DB112225.eps 	2 short			LV429235	LV432475
	2 long			LV429236	LV432476
Terminal shield					
DB432107.eps 	1 short terminal shield for breaker or plug-in base		4P	LV429516	LV432592
Bare cable connectors					
DB112226.eps 	Steel connectors	1.5 to 95 mm ² ; ≤ 160 A	Set of 2	LV429246	
			Set of 3	LV429242	
			Set of 4	LV429243	
DB112725.eps 	Aluminium connectors	25 to 95 mm ² ; ≤ 250 A	Set of 2	LV429255	
			Set of 3	LV429227	
			Set of 4	LV429228	
		120 to 185 mm ² ; ≤ 250 A	Set of 2	LV429247	
			Set of 3	LV429259	
			Set of 4	LV429260	
DB112726.eps 	Clips for connectors		Set of 10	LV429241	
DB112227.eps 	Aluminium connectors for 2 cables ^[1] 2 x (50 to 120 mm ²) ; ≤ 250 A		Set of 3 (3P)	LV429218	
			Set of 4 (4P)	LV429219	
	Aluminium connectors 1 x (35 to 300 mm ²)		Set of 3 (3P)		LV432479
			Set of 4 (4P)		LV432480
DB112228.eps 	Aluminium connectors ^[1] for 6 cables 6 x (1.5 to 35 mm ²) ; ≤ 250 A		Set of 3 (3P)	LV429248	
			Set of 4 (4P)	LV429249	
	Aluminium connectors for 2 cables 2 x (35 to 300 mm ²)		Set of 3 (3P)		LV432481
			Set of 4 (4P)		LV432482
DB112724.eps 	6.35 mm voltage tap for steel or aluminium connectors		Set of 10	LV429348	





[1] Supplied with 2 or 3 interphase barriers.

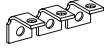

Compact NSX80/500 TM DC PV to NSX100/500 NA DC PV

Connection accessories (cont.)

Connection accessories (Cu or Al)

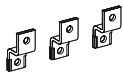
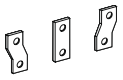
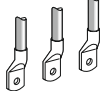
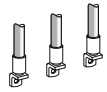
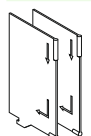
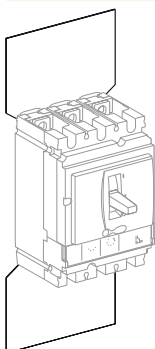
			NSX100-250 DC PV	NSX400-630 DC PV
Terminal extensions				
	Right-angle terminal extensions	Set of 2	LV429250	
		Set of 3	LV429261	LV432484
		Set of 4	LV429262	LV432485
	Straight terminal extensions	Set of 2	LV429251	
		Set of 3	LV429263	
		Set of 4	LV429264	
	45° terminal extension ^[1]	Set of 3	LV429223	
		Set of 4	LV429224	
	Edgewise terminal extensions ^[1]	Set of 3	LV429308	LV432486
		Set of 4	LV429309	LV432487
	Double-L terminal extensions ^[1]	Set of 3	LV429221	
		Set of 4	LV429222	
	Spreaders from 35 to 45 mm pitch ^[1]	3P	LV431563	
		4P	LV431564	
Crimp lugs for copper cable (supplied with 2 or 3 interphase barriers)				
	For cable 120 mm ²	Set of 3	LV429252	
		Set of 4	LV429256	
	For cable 150 mm ²	Set of 3	LV429253	
		Set of 4	LV429257	
	For cable 185 mm ²	Set of 3	LV429254	
		Set of 4	LV429258	
For cable 240 mm ²	Set of 3		LV432500	
	Set of 4		LV432501	
For cable 300 mm ²	Set of 3		LV432502	
	Set of 4		LV432503	
Crimp lugs for aluminium cable (supplied with 2 or 3 interphase barriers)				
	For cable 150 mm ²	Set of 3	LV429504	
		Set of 4	LV429505	
	For cable 185 mm ²	Set of 3	LV429506	
		Set of 4	LV429507	
	For cable 240 mm ²	Set of 3		LV432504
Set of 4			LV432505	
For cable 300 mm ²	Set of 3		LV432506	
	Set of 4		LV432507	
Barriers				
	Interphase barriers	Set of 6	LV429329	LV432570
Insulation screen				
	2 insulating screens for breaker (45 mm pitch)	3P	LV429330	
		4P	LV429331	
	2 insulating screens for breaker (70 mm pitch)	3P		LV432578
		4P		LV432579

[1] Supplied with 2 or 3 interphase barriers.

Note: circuit breakers or switch-disconnectors must be in "off" position when fitting the mechanical or electrical accessories.

Compact NSX80/500 TM DC PV to NSX100/500 NA DC PV Electrical auxiliaries

Electrical auxiliaries

Auxiliary contacts (changeover)



DB112254.eps 	OF or SD or SDE or SDV		29450	
	OF or SD or SDE or SDV low level		29452	
	SDE adapter, mandatory for trip unit		LV429451	
Voltage releases		MX	MN	
DB111454.eps 	AC	24 V 50/60 Hz	LV429384	LV429404
		48 V 50/60 Hz	LV429385	LV429405
		110-130 V 50/60 Hz	LV429386	LV429406
		220-240 V 50/60 Hz 208-277 V 60 Hz	LV429387	LV429407
		380-415 V 50 Hz 440-480 V 60 Hz	LV429388	LV429408
		525 V 50 Hz - 600 V 60 Hz	LV429389	LV429409
	DC	12 V	LV429382	LV429402
		24 V	LV429390	LV429410
		30 V	LV429391	LV429411
		48 V	LV429392	LV429412
	60 V	LV429383	LV429403	
	125 V	LV429393	LV429413	
	250 V	LV429394	LV429414	
MN 48 V 50/60 Hz with fixed time delay				
Composed of:	MN 48 V DC		LV429412	
	Delay unit 48 V 50/60 Hz		LV429426	
MN 220-240 V 50/60 Hz with fixed time delay				
Composed of:	MN 250 V DC		LV429414	
	Delay unit of 220-240 V 50/60 Hz		LV429427	
MN 48 V DC/AC 50/60 Hz with adjustable time delay				
Composed of:	MN 48 V DC		LV429412	
	Delay unit 48 V DC/AC 50/60 Hz		33680	
MN1 10-130 V DC/AC 50/60 Hz with adjustable time delay				
Composed of:	MN 125 V DC		LV429413	
	Delay unit 100-130 V DC/AC 50/60 Hz		33681	
MN 220-250 V DC/AC 50/60 Hz with adjustable time delay				
Composed of:	MN 250 V DC		LV429414	
	Delay unit 200-250 V DC/AC 50/60 Hz		33682	

Motor mechanism

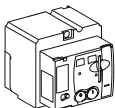
Motor mechanism module supplied with SDE adapter

DB125554.eps 	AC	Voltage	MT100/160	MT250	MT400-630
		48-60 V 50/60 Hz	LV429440	LV431548	LV432639
		110-130 V 50/60 Hz	LV429433	LV431540	LV432640
		220-240 V 50/60 Hz	LV429434	LV431541	LV432641
		208-277 V 60 Hz			
		380-415 V 50/60 Hz	LV429435	LV431542	LV432642
		440-480 V 60 Hz			LV432647
	DC	24-30 V	LV429436	LV431543	LV432643
		48-60 V	LV429437	LV431544	LV432644
		110-130 V	LV429438	LV431545	LV432645
250 V		LV429439	LV431546	LV432646	
Operations counter				LV432648	

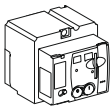
Communicating motor mechanism module supplied with SDE adapter

DB112265.eps   	Motor mechanism module	MTc 100/160	220-240 V 50/60 Hz	LV429441	
		MTc 250	220-240 V 50/60 Hz	LV431549	
		MTc 400/630	220-240 V 50/60 Hz	LV432652	
	+	Breaker and Status Communication Module	BSCM		LV434205
	+	NSX cord	Wire length L = 0.35 m		LV434200
			Wire length L = 1.3 m		LV434201
			Wire length L = 3 m		LV434202
			U > 480 V AC wire length L = 0.35 m		LV434204





Compact NSX80/500 TM DC PV to NSX100/500 NA DC PV





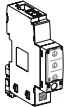

Electrical auxiliaries

Communication option ^[1]

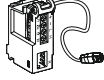
ULP communication module

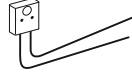
	IFE	Ethernet interface for LV breaker	LV434001
		Ethernet interface for LV breakers and gateway	LV434002
	IFM Modbus-SL interface module		LV434000
	I/O application module		LV434063
	User guide IFE		DOCA0084EN
	User guide I/O application module		DOCA0055EN

ULP wiring accessories

	NSX cord L = 0.35 m		LV434200
	NSX cord L = 1.3 m		LV434201
	NSX cord L = 3 m		LV434202
	NSX cord for U > 480 V AC L = 1.3 m		LV434204
	10 stacking connectors for communication interface modules		TRV00217
	2 Modbus line terminators		VW3A8306DRC ^[2]
	RS 485 roll cable (4 wires, length 60 m)		50965
	5 RJ45 connectors female/female		TRV00870
	10 ULP line terminators		TRV00880
	10 RJ45/RJ45 male cord L = 0.3 m		TRV00803
	10 RJ45/RJ45 male cord L = 0.6 m		TRV00806
	5 RJ45/RJ45 male cord L = 1 m		TRV00810
	5 RJ45/RJ45 male cord L = 2 m		TRV00820
	5 RJ45/RJ45 male cord L = 3 m		TRV00830
	1 RJ45/RJ45 male cord L = 5 m		TRV00850
	2 wires RS 485 insulated repeated		TRV00211

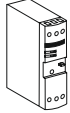
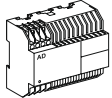

Power supply modules

	External power supply module 100-240 V AC 110-230 V DC / 24 V DC-3 A class 2		ABL8RPS24030
	External power supply module 24 V DC-1 A OVC IV		
	24-30 V DC		54440
	48-60 V DC		54441
	100-125 V AC		54442
	110-130 V AC		54443
	200-240 V AC		54444
380-415 V AC		54445	

[1] NSX80-250 DC PV TM/NA only.

[2] www.schneider-electric.com.

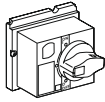
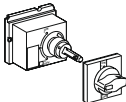
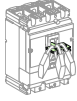
Compact NSX80/500 TM DC PV to NSX100/500 NA DC PV Operation and locking/Interlocking

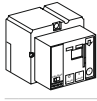
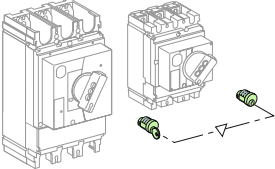
Rotary handles		NSX100-250 DC PV	NSX400-630 DC PV	
Direct rotary handles				
DB432037.eps 	With black handle	LV429337	LV432597	
	With red handle on yellow front	LV429339	LV432599	
	MCC conversion accessory	LV429341	LV432606	
	CNOMO conversion accessory	LV429342	LV432602	
Extended rotary handle				
DB432038.eps 	With black handle	LV429338	LV432598	
	With red handle on yellow front	LV429340	LV432600	
	With telescopic handle for withdrawable device	LV429343	LV432603	
Accessories				
Indication auxiliary		1 early-break contact	LV429345	LV432605
		2 early-break contacts	LV429346	LV429346
Locks		NSX100-250 DC PV	NSX400-630 DC PV	
Toggle locking device for 1 to 3 padlocks				
DB432039.eps 	By removable device		29370	29370
	DB432100.eps 	By fixed device (open or close position)		LV429371
By fixed device (open position only)		LV429370 ^[1]	LV432630 ^[1]	
Locking of the rotary handle				
DB432103.eps 	Keylock adapter (keylock not included)		LV429344	LV432604
	Keylock (keylock adapter not included)	Ronis 1351B.500	41940	41940
		Profalux KS5 B24 D4Z	42888	42888
Locking of the motor mechanism modules				
DB432104.eps 	Keylock adapter + Ronis keylock (special)		LV429449	LV432649
	Keylock (keylock adapter not included)	Ronis 1351B.500		41940
		Profalux KS5 B24 D4Z	42888	
Interlocking		NSX100-250 DC PV	NSX400-630 DC PV	
Interlocking with key (2 keylocks / 1 key) for rotary handles				
DB432576.eps 	Keylock kit (keylock not included) ^[2]		LV429344	LV432604
	1 set of 2 keylocks	Ronis 1351B.500	41950	41950
		(1 key only, keylock kit not included)	Profalux KS5 B24 D4Z	42878

[1] Available February 2014.

[2] NSX100-250 DC PV only.



Compact NSX80/500 TM DC PV to NSX100/500 NA DC PV Installation

Installation accessories

NSX100-250
DC PV

NSX400-630
DC PV

Front-panel escutcheons

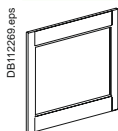

IP30

IP30 escutcheon for all control types
IP30 trip unit access escutcheon for toggle

LV429525
LV429526

LV432557
LV432559

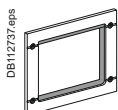

IP40

IP40 escutcheon for all control types

LV429317

LV432558

IP43 rubber toggle cover

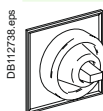

1 toggle cover

LV429319

LV432560

Lead-sealing accessories



Bag of accessories

LV429375

LV429375

Din rail adapter

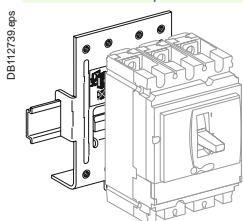

1 adapter

LV429305

Compact NSX630b to 1600 NA DC PV fixed electrically operated Complete device without motor mechanism module

Complete molded case switch-disconnector (without motor mechanism module)

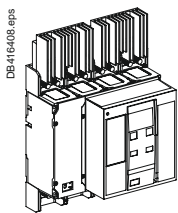

Molded case switch disconnector Compact NSX630b NA DC PV 630 A 4P	LV438969
Molded case switch disconnector Compact NSX800 NA DC PV 800 A 4P	LV438970
Molded case switch disconnector Compact NSX1000 NA DC PV 1000 A 4P	LV438971
Molded case switch disconnector Compact NSX1250 NA DC PV 1250 A 4P	LV438972
Molded case switch disconnector Compact NSX1600 NA DC PV 1500 A 4P	LV438973

Note: all references above include :

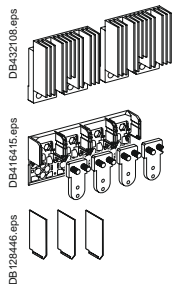

Basic frame	
Heatsink	Kit of 2 (LV438966)
Front connection :	Top (33612) Bottom (33613)
Interphase barriers	Kit of 3 (33646)

Electrical auxiliaries for complete device

Indication contacts



OF, ON/OFF indication contacts	6 A - 240 V	Low level
Up to 3 OF can be connected.	33108	33109

Instantaneous voltage releases

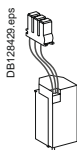

	MX	MN	Delay unit	R (non-adjustable)	Rr (adjustable)
12 V DC	33658				
24/30 V DC	33659	33668			
48/60 V DC	33660	33669	48/60 V DC		33680
100/130 V DC	33661	33670	100/130 V DC	33684	33681
200/250 V DC	33662	33671	200/250 V DC	33685	33682
			380/480 V DC		33683



Compact NSX630b to 1600 NA DC PV fixed electrically operated

Device based on separate components with or without motor mechanism module

Basic frame molded case switch-disconnector

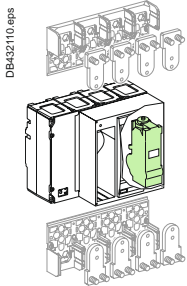

Compact NSX type NA		4P
NSX630b NA DC PV		LV453421
NSX800 NA DC PV		LV453423
NSX1000 NA DC PV		LV453425
NSX1250 NA DC PV		LV453427
NSX1600 NA DC PV		LV453429

Note: the characteristics of the motor mechanism module for electrical operation are specified separately by selecting a part number from the table at the bottom of this page.

Connections for basic frame molded case switch-disconnectors

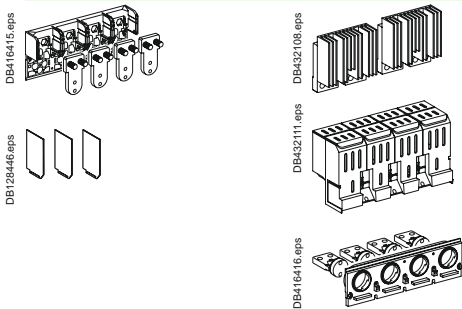

Front connection		4P
Top	630-1000 A - NA	33612
	Heatsink mandatory Kit of 2	LV438966
Bottom	interphase barriers* Kit of 3	33646
or	Terminal shield*	LV438968
* interphase barriers or terminal shield is mandatory		
Front connection	630-1000 A - NA Bottom	33609
	630-1000 A - L Bottom	33611
	1600 A - NA Bottom	33613
Rear connection	Vertical NA Bottom	33615
	Horizontal NA Bottom	33617

Electrical auxiliaries

Indication contacts



OF, ON/OFF indication contacts Up to 3 OF can be connected.	6 A - 240 V	Low level
	33108	33109

Instantaneous voltage releases

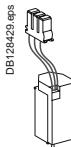

	MX	MN	Delay unit	R (non-adjustable)	Rr (adjustable)
12 V DC	33658				
24/30 V DC	33659	33668			
48/60 V DC	33660	33669	48/60 V DC		33680
100/130 V DC	33661	33670	100/130 V DC	33684	33681
200/250 V DC	33662	33671	200/250 V DC	33685	33682
			380/480 V DC		33683

Communication options

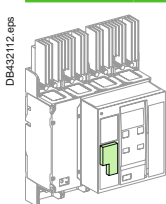

For fixed devices	Electrically operated
Modbus COM	33708

Motor mechanism module

DC



	Standard	Communicating
24/30 V	33690	33697
48/60 V	33691	33698
100/130 V	33692	33699
200/250 V	33693	33700

Note: to order a complete device, order:

- a basic frame switch disconnector
- connections
- electrical auxiliaries.
- communication option as required.
- motor mechanism as required.

Compact INS40 to 160 DC

Complete fixed/FC device and accessories

Compact INS40 to 160 standard version with black handle

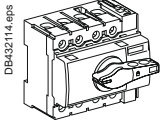

	3P	4P
Compact INS40	28900	28901
Compact INS63	28902	28903
Compact INS80	28904	28905
Compact INS80PV - Photovoltaic	-	28907

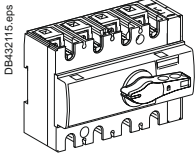

	3P	4P
Compact INS100	28908	28909
Compact INS125	28910	28911
Compact INS160	28912	28913

Compact INS40 to 160 with red handle and yellow front

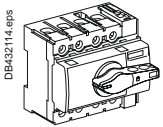

	3P	4P
Compact INS40	28916	28917
Compact INS63	28918	28919
Compact INS80	28920	28921

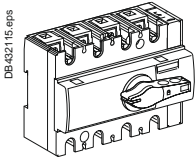

	3P	4P
Compact INS100	28924	28925
Compact INS125	28926	28927
Compact INS160	28928	28929



Compact INS40 to 160 DC Accessories

Connection accessories (cont.)

Connectors for bare Cu or Al cables

DB43216.eps 	Snap-in	INS100 to 160 S ≤ 95 mm ²	Set of 3	28947
			Set of 4	28948
DB43217.eps 	Distribution connector for 3 rigid cables up to 16 mm ² or 3 flexible cables up to 10 mm ²	INS40 to 80	Set of 3	19096
			Set of 4	19091
DB43218.eps 	Distribution connector for 4 rigid cables up to 25 mm ² or 4 flexible cables up to 16 mm ²	INS100 to 160	Set of 3	28949
			Set of 4	28950

Crimp lugs for copper cables

DB43219.eps 	For 95 mm ² cables with interphase barriers	INS100 to 160	Set of 3	28951
			Set of 4	28952

Terminal shrouds

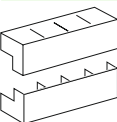
DB43220.eps 	INS40 to 80	3P/4P	Set of 2	28955
	INS100 to 160	3P/4P	Set of 2	28956

Terminal shields

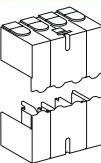
DB43221.eps 	INS40 to 80	3P/4P	Set of 2	28957
	INS100 to 160	3P/4P	Set of 2	28958

Interphase barriers

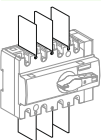
DB43222.eps 	INS100 to 160	3P/4P	Set of 6	28959
--	---------------	-------	----------	--------------

Electrical auxiliaries

Auxiliary contacts

DB43223.eps 	1 CAF / CAO standard (early make or break)	INS40 to 160	29450
	1 CAF / CAO low level (early make or break)	INS40 to 160	29452

Rotary handles

Direct front control or lateral control

Built-in

Accessories for conversion to extended rotary handles

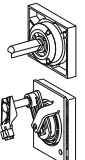
DB43224.eps 	Front control	Black handle	INS40 to 160	LV428941	
		Red handle on yellow front	INS40 to 160	LV428942	
DB43225.eps 	Lateral control	Black handle	INS40 to 160	28943	
		Red handle on yellow front	INS40 to 160 ^[1]	28944	
		Lateral control on PRAGMA F functional enclosure	Black handle	INS40 to 160	28945^[2]
			Red handle on yellow front	INS40 to 160 ^[1]	28946

[1] For red/yellow switch versions only.

[2] Not available with Prisma.

Catalogue numbers

Compact INS40 to 160 DC

Accessories

Locking and interlocking

Handle locking

DB432126.eps

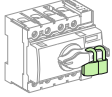

By 1 to 3 padlocks (OFF position), hasp dia. 5 to 8 mm, or by lead seals

Built-in

Interlocking for extended rotary handles

DB432127.eps

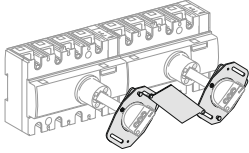

Mechanical

28953

Compact INS250-100 to 630 DC

Complete fixed/FC device and accessories

Compact INS250 to 630 standard version with black handle

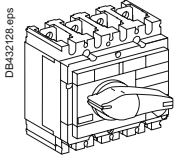

	3P	4P
Compact INS250-100A	31100	31101
Compact INS250-160A	31104	31105
Compact INS250-200A	31102	31103
Compact INS250	31106	31107

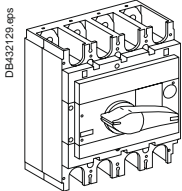

	3P	4P
Compact INS320	31108	31109
Compact INS400	31110	31111
Compact INS500	31112	31113
Compact INS630	31114	31115

Compact INS250 to 630 with red handle and yellow front

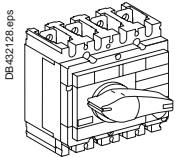

	3P	4P
Compact INS250-100A	31120	31121
Compact INS250-160A	31124	31125
Compact INS250-200A	31122	31123
Compact INS250	31126	31127

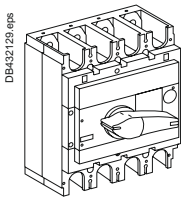

	3P	4P
Compact INS320	31128	31129
Compact INS400	31130	31131
Compact INS500	31132	31133
Compact INS630	31134	31135

Compact INV100 to 630 DC

Complete fixed/FC device and specific accessories

Compact INV100 to 630 standard version with black handle

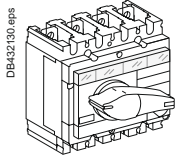

	3P	4P
Compact INV100	31160	31161
Compact INV160	31164	31165
Compact INV200	31162	31163
Compact INV250	31166	31167

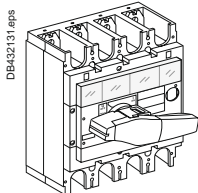

	3P	4P
Compact INV320	31168	31169
Compact INV400	31170	31171
Compact INV500	31172	31173
Compact INV630	31174	31175

Compact INV100 to 630 with red handle and yellow front

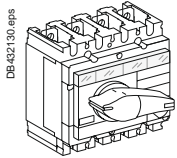

	3P	4P
Compact INV100	31180	31181
Compact INV160	31184	31185
Compact INV200	31182	31183
Compact INV250	31186	31187

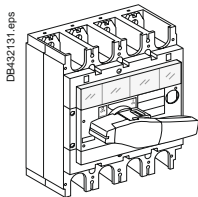









	3P	4P
Compact INV320	31188	31189
Compact INV400	31190	31191
Compact INV500	31192	31193
Compact INV630	31194	31195

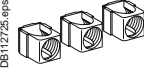

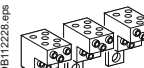
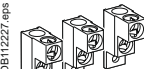
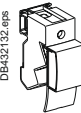
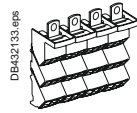
Compact INS250-100 to 250 DC and Compact INV100 to 250 DC Accessories

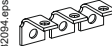
Connection accessories

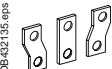
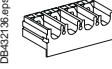
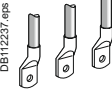
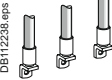
Rear connections				
	Short (1 pair)			LV429235
	Long (1 pair)			LV429236
Cable connectors				
	Snap-on, for cables:	Steel: 1.5 to 95 mm ² ; ≤ 160 A	Set of 3	LV429242
			Set of 4	LV429243
		Aluminium: 25 to 95 mm ² ; ≤ 250 A	Set of 3	LV429227
			Set of 4	LV429228
		Aluminium: 120 to 185 mm ² ; ≤ 250 A	Set of 3	LV429259
			Set of 4	LV429260
	Tab connector for voltage tap on 185 mm ² cable connector		Set of 10	LV429348
	Clip for cable connector		Set of 10	LV429241
	Distribution connector for six 1.5 to 35 mm ² cables with interphase barriers		Set of 3	LV429248
			Set of 4	LV429249
	Aluminium connectors for 2 cables: 2 x (50 to 120 mm ²); ≤ 250 A		Set of 3	LV429218
			Set of 4	LV429219
Linery DX and DP distribution block				
	Linery DX 160 A	For 6 cables (16 mm ²) per pole ^[1]	1P	04031
	Linery DP 250 A	For 9 cables (6 x 10 mm ² + 3 x 16 mm ²) per pole ^[1]	3P	04033
			4P	04034
			3P	04155
			4P	04156
		Additional blocks of 2 x 35 mm ² per pole ^[1]	3P	04155
			4P	04156
Linery DS distribution block				
	Linery DS 250 A	For 14 holes (1 x 15.3 mm ² + 1 x 10 mm ² + 4 x 6 mm ² + 8 x 7.5 mm ²)	1P	LG125014
Terminal extensions (supplied with 2 or 3 interphase barriers)				
	Right-angle terminal extensions ^[1]		Set of 3	LV429261
			Set of 4	LV429262
	Straight terminal extensions ^[1]		Set of 3	LV429263
			Set of 4	LV429264
Spreaders (for upstream or downstream connection)				
	Separate for each pole		3P	LV431563
			4P	LV431564
	One-piece Front alignment base for one-piece spreader (when mounting with LV432594 and LV432596, refer chapter dimensions and connection in catalogue Compact INS/INV "LVPED213024EN")		3/4P	LV431061
			3/4P	LV431064
Crimp lugs for copper cables (supplied with 2 or 3 interphase barriers)				
		For 120 mm ² cables	Set of 3	LV429252
			Set of 4	LV429256
		For 150 mm ² cables	Set of 3	LV429253
			Set of 4	LV429257
		For cable 185 mm ² cables	Set of 3	LV429254
	Set of 4	LV429258		
Crimp lugs for aluminium cables (supplied with 2 or 3 interphase barriers)				
		For 150 mm ² cables	Set of 3	LV429504
			Set of 4	LV429505
		For 185 mm ² cables	Set of 3	LV429506
			Set of 4	LV429507

[1] Supplied with 2 or 3 interphase barriers.

Compact INS250-100 to 250 DC and Compact INV100 to 250 DC Accessories

Connection accessories

Terminal shields

DB432137.eps	1 Short	3/4 P	LV429516
	1 Long	3/4 P	LV429518

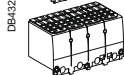

Interphase barriers

DB432138.eps		Set of 6	LV429329
--------------	--	----------	----------

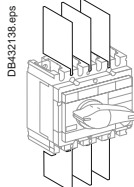

Special connection accessories for INS250-100 to 250DC and INV100 to 250DC

DB432139.eps	Terminal extensions for series or parallel connection of two poles ^[1]	1 terminal ext.	LV438328
--------------	---	-----------------	----------

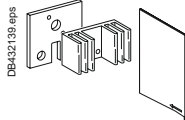

DB432140.eps	Terminal extensions for parallel connection of three poles: Parallel connection of:	3 poles = set of 2 terminal extensions	LV438329
--------------	--	--	----------

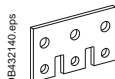

DB432137.eps	4P terminal shields for series connection of poles	Set of 1	LV438326
	4P terminal shields for parallel connection of poles (2P/4P)	Set of 1	LV438327

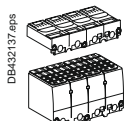

Electrical auxiliaries

Auxiliary contacts (changeover type)

DB432123.eps	CAM (early make or break)	29450
	Low level CAM (early make or break)	29452



Rotary handles

Front control

DB432124.eps	Direct for INS/INV250	Built-in
	Extended	
	For INS/INV250 with standard rotary handle	LV431050
	For INS/INV250 with red handle on yellow front	^[2] LV431051
	For complete source changeover assembly	31055

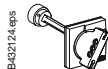

Lateral control

DB432125.eps	Direct lateral control for INS/INV250	
	Lateral support	31054
	+ standard lateral control assembly	31057
	or + red and yellow lateral control assembly	^[2] 31058
	Extended lateral control for INS/INV250	
	Standard lateral control assembly	31057
Red and yellow lateral control assembly	^[2] 31058	

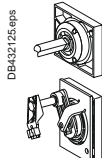

[1] Series connection of: 2 poles = 1 terminal extension
3 poles = 2 terminal extensions
4 poles = 3 terminal extensions
Parallel connection of: 2 poles = 2 terminal extensions
4 poles = 4 terminal extensions

[2] For red/yellow switch versions only.



Compact INS250-100 to 250 DC and Compact INV100 to 250 DC Accessories

Locking and interlocking for INS/INV and source changeover systems

Locking for INS/INV

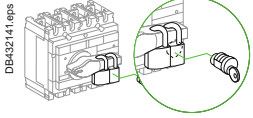

Handle locking by 1 to 3 padlocks (in OFF position)

By keylock

Keylocking device	2 x	31087
+ Ronis 1351B.500 keylock		41940
or + Profalux KS5 B24 D4Z keylock		42888

Built-in

Locking for INS complete source changeover assembly

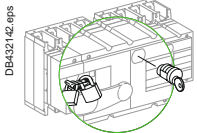

Handle locking by 1 to 3 padlocks (in OFF position)

By keylock

Keylocking device		31097
+ Ronis 1351B.500 keylock		41940
or + Profalux KS5 B24 D4Z keylock		42888

Built-in

Interlocking with key (2 keylocks / 1 key)

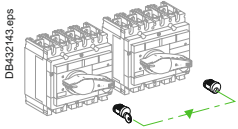

By 2 keylocks

INS250 keylocking device	2 x	31087
INS320-630 keylocking device	2 x	31088
+ Ronis 1351B.500 keylock	2 x	41950
or + Profalux KS5 B24 D4Z keylock	2 x	42878

Interlocking for INS/INV with direct or extended rotary handle

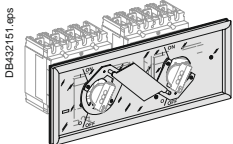





Mechanical interlocking for INS250

31073

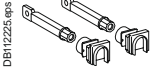
Compact INS320 to 630 DC and Compact INV320 to 630 DC Accessories

Connection accessories

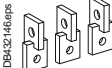
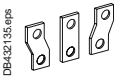
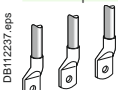
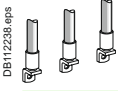
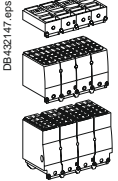
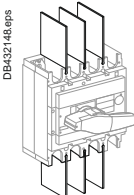
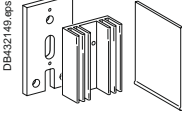
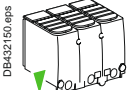
Rear connections				
	Short (1 pair)			LV432475
	Long (1 pair)			LV432476
Cable connectors				
	For 1 cable, 35 mm ² to 300 mm ²		Set of 3	LV432479 ^[1]
			Set of 4	LV432480 ^[2]
	For 2 cables, 35 mm ² to 240 mm ²		Set of 3	LV432481 ^[1]
			Set of 4	LV432482 ^[2]
	Tab connector for voltage tap on cable connector		Set of 10	LV429348
Terminal extensions (supplied with 2 or 3 interphase barriers)				
	Right-angle terminal extensions		Set of 3	LV432484
			Set of 4	LV432485
	Edgewise terminal extensions		Set of 3	LV432486
			Set of 4	LV432487
Spreaders (for upstream or downstream connection)				
	One-piece	52.5 mm	3P	LV432490
			4P	LV432491
	70 mm	3P	LV432492	
		4P	LV432493	
Crimp lugs for copper cables (supplied with 2 or 3 interphase barriers)				
	For 240 mm ² cables		Set of 3	LV432500
			Set of 4	LV432501
	For 300 mm ² cables		Set of 3	LV432502
			Set of 4	LV432503
Crimp lugs for aluminium cables (supplied with 2 or 3 interphase barriers)				
	For 240 mm ² cables		Set of 3	LV432504
			Set of 4	LV432505
	For 300 mm ² cables		Set of 3	LV432506
			Set of 4	LV432507
Terminal shields				
	1 Short		3/4P	LV432592
	1 Long		3/4P	LV432594
	1 Long for 52.5 mm spreader (supplied with insulating plate)		3/4P	LV432596
Interphase barriers				
			Set of 6	LV432570
Special connection accessories for INS/INV320 to 630DC				
	Terminal extensions for series or parallel connection of two poles ^[3]		1 connection plate equipped with heat sink + 1 interphase barrier	LV438338
		4P terminal shields for series connection of poles	Set of 1	LV438346
	4P terminal shields for parallel connection of poles	Set of 1	LV438337	

[1] Kit comprising 2 interphase barriers.

[2] Kit comprising 3 interphase barriers.

[3] Series connection of: 2 poles = 1 terminal extension
3 poles = 2 terminal extensions
4 poles = 3 terminal extensions

Parallel connection of: 2 poles = 2 terminal extensions
4 poles = 4 terminal extensions



Compact INS320 to 630 DC and Compact INV320 to 630 DC Accessories

Electrical auxiliaries

Auxiliary contacts (changeover type)

DB432123.eps 	1 OF/CAF/CAO (early make or break)	29450
	1 OF/CAF/CAO low level (early make or break)	29452

Rotary handles

Extended front control

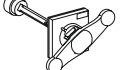
DB432152.eps 	For INS320/400/630 with standard rotary handle	31052
	For INS320/400/630 with red handle on yellow front	^[1] 31053
	For complete source changeover assembly	31055

Locking and interlocking for INS/INV and source changeover systems

Locking for INS/INV

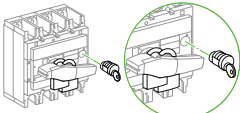
DB432153.eps 	Handle locking by 1 to 3 padlocks (in OFF position)		Built-in
	By keylock	Keylocking device	31088
		+ Ronis 1351B.500 keylock	41940
		or + Profalux KS5 B24 D4Z keylock	42888

Locking for INS complete source changeover assembly

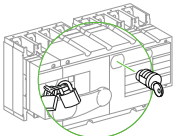
DB432154.eps 	Handle locking by 1 to 3 padlocks (in OFF position)		Built-in
	By keylock	Keylocking device	31097
		+ Ronis 1351B.500 keylock	41940
		or + Profalux KS5 B24 D4Z keylock	42888

Interlocking with key (2 keylocks / 1 key)

DB432143.eps 	By 2 keylocks	INS250 keylocking device	2 x	31087
		INS320-630 keylocking device	2 x	31088
		+ Ronis 1351B.500 keylock	2 x	41950
		or + Profalux KS5 B24 D4Z keylock	2 x	42878

Interlocking for INS/INV with direct or extended rotary handle

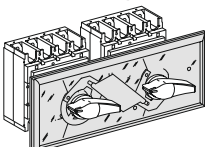
DB432155.eps 	Mechanical interlocking for INS320/400/630	31074
---	--	--------------

Compact INS630b to 2500 DC

Complete fixed/FC device and accessories

Compact INS630b to 2500 standard version with black handle

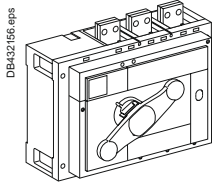

DB432156.eps

	3P	4P
Compact INS630b	31342	31343
Compact INS800	31330	31331
Compact INS1000	31332	31333
Compact INS1250	31334	31335
Compact INS1600	31336	31337

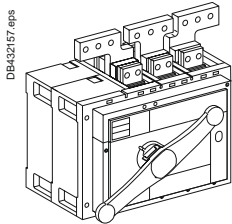

DB432157.eps

Compact INS2000	31338	31339
Compact INS2500	31340	31341

Compact INS800 to 1600 with red handle and yellow front

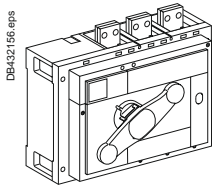

DB432156.eps

	3P	4P
Compact INS800	31344	31345
Compact INS1000	31346	31347
Compact INS1250	31348	31349
Compact INS1600	31350	31351



Compact INV630b to 2500 DC

Complete fixed/FC device and specific accessories

Compact INV630b to 2500 standard version with black handle

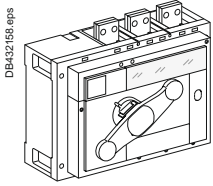

	3P	4P
Compact INV630b	31370	31371
Compact INV800	31358	31359
Compact INV1000	31360	31361
Compact INV1250	31362	31363
Compact INV1600	31364	31365

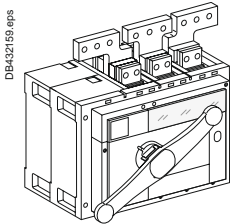

Compact INV2000	31366	31367
Compact INV2500	31368	31369

Compact INV800 to 1600 with red handle and yellow front

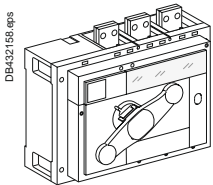

	3P	4P
Compact INV800	31372	31373
Compact INV1000	31374	31375
Compact INV1250	31376	31377
Compact INV1600	31378	31379

Compact INS630b to 2500 DC and Compact INV630b to 2500 DC Accessories

Connection accessories

Vertical connection adapters

	INS/INV630b-1600	3P	Set of 3	31301
		4P	Set of 4	31302

Cable lug adapters

	INS/INV630b-1600	3P	Set of 3	33644
		4P	Set of 4	33645

Busbar connection (not compatible with terminal shield)

	INS/INV630b-1600	3P	Set of 3	31305
		4P	Set of 4	31306

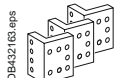
	Right angle connector for busbar (edgewise) to INS2000/2500			31310
---	---	--	--	--------------

Insulation accessories

Base for terminal shield (not compatible with interphase barriers)

	INS/INV630b-1600	3P		31307
		4P		31308

Terminal shield

	INS/INV630b-1600	3P		LV433638
		4P		LV433639

Interphase barriers (not compatible with terminal shield and base)

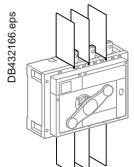
	INS/INV630b-1600	4P	Set of 6	31315
	INS/INV2000/2500	4P	Set of 6	31319

Electrical auxiliaries

Auxiliary contacts (changeover type) INS/INV630b-2500

	1 OF/CAF/CAO standard (early make or break)			29450
	1 OF/CAF/CAO low level (early make or break)			29452

Extended front control

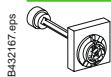
	INS/INV630b-2500	For standard rotary handle		31288
	INS/INV630b-1600	For red handle on yellow front	[1]	31289

[1] For red/yellow switch versions only.



Catalogue numbers

Compact INS630b to 2500 DC and Compact INV630b to 2500 DC Accessories

Locking and interlocking

Locking for INS/INV630b to 2500

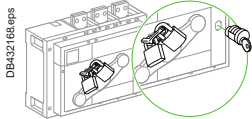

Handle locking by 1 to 3 padlocks (in OFF position)

By keylock

Keylocking device
+ Ronis 1351B.500 keylock
or + Profalux KS5 B24 D4Z keylock

Built-in

31291

41940

42888

Interlocking for INS/INV630b to 2500

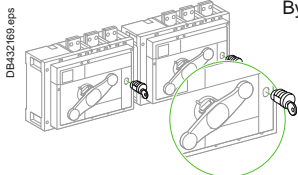

By keylock

Keylocking device 2 x
+ Ronis 1351B.500 keylock (1 key) 2 x
or + Profalux KS5 B24 D4Z keylock (1 key) 2 x

31291

41950

42878

NW10 DC to NW40 DC fixed and drawout circuit breakers and switch-disconnectors

A Masterpact DC circuit breaker is described by 2 catalogue numbers corresponding to:

- the basic circuit breaker (fixed or drawout with chassis, including the power connections)
- a control unit.

A Masterpact switch-disconnector is described by 1 catalogue number corresponding to:

- the switch-disconnector (fixed or drawout with chassis, including the power connections).

Vertical connection is standard however the connectors can be rotated for on-site conversion to horizontal connection (except on the NW40).

A communication option and various auxiliaries and accessories may also be added.

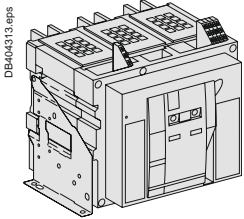

Switch-disconnector ≤ 4000 A.

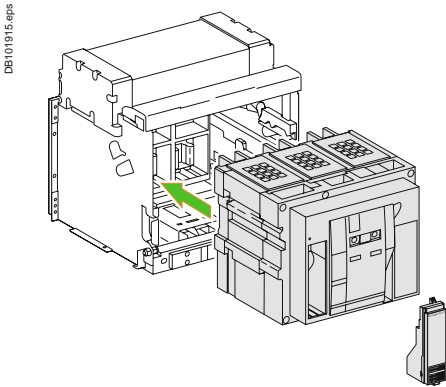

Basic circuit breaker + chassis ≤ 4000 A.

Basic circuit breaker

Type N				
	In (A at 40 °C)	Icu (kA for U = 500 V DC)	Fixed	Drawout
NW10NDC-C	1000	35	48645	48660
NW20NDC-C	2000	35	48646	48661
NW40NDC-C	4000	35	48647	48662

Type H				
	In (A at 40 °C)	Icu (kA for U = 500 V DC)	Fixed	Drawout
NW10HDC-C	1000	85	48648	48663
NW10HDC-D	1000	85	48649	48664
NW10HDC-E	1000	85	48650	48665
NW20HDC-C	2000	85	48651	48666
NW20HDC-D	2000	85	48652	48667
NW20HDC-E	2000	85	48653	48668
NW40HDC-C	4000	85	48654	48669
NW40HDC-D	4000	85	48655	48670
NW40HDC-E	4000	85	48656	48671

DC 1.0 Micrologic control unit

Setting range				
Minimum (A ±8 %)	Maximum (E ±10 %)	Type	Fixed	Drawout
1250	2500	N, H type C	65266	65269
2500	5400	N, H type C	65267	65270
5000	11000	N, H type C	65268	65271
1250	2500	H type D	65272	65275
2500	5400	H type D	65273	65276
5000	11000	H type D	65274	65277
1250	2500	H type E	65278	65281
2500	5400	H type E	65279	65282
5000	11000	H type E	65280	65283

Switch-disconnector

Type HA				
	In (A at 40 °C)	Icm (kA)	Fixed	Drawout
NW10HADC-C	1000	85	48684	48698
NW10HADC-D	1000	85	48685	48699
NW10HADC-E	1000	85	48879	48882
NW20HADC-C	2000	85	48687	48701
NW20HADC-D	2000	85	48688	48702
NW20HADC-E	2000	85	48880	48883
NW40HADC-C	4000	85	48690	48704
NW40HADC-D	4000	85	48691	48705
NW40HADC-E	4000	85	48881	48884

Switch-disconnector for PV

Type HA				
	In	Icm (kA)	Fixed	Drawout
NW20HADCD-PV	2000	85	48975	47651
NW40HADCD-PV	4000	85	48797	47652



NW10 DC to NW40 DC fixed circuit breakers

Indication contacts

ON/OFF indication contacts (OF)

DB404314.eps

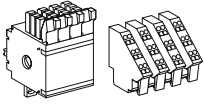

Block of 4 changeover contacts (6 A - 240 V)	1 block (standard)
1 additional block of 4 contacts (2 max.)	48198

"Fault trip" indication contacts (SDE)

DB404315.eps

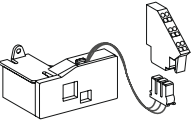

Changeover contact (5 A - 240 V)	1 (standard)
1 additional SDE (5 A - 240 V)	48200
1 additional low-level SDE	48201

NW10 DC to NW40 DC fixed circuit breakers

Remote operation

Remote ON/OFF

Gear motor

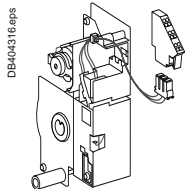

			MCH
AC 50/60 Hz	48 V		48207
	100/130 V		48211
	200/240 V		48212
	250/277 V		48213
	380/415 V		48214
	440/480 V		48215
DC	24/30 V		48206
	48/60 V		48207
	100/130 V		48208
	200/250 V		48209

Instantaneous voltage releases

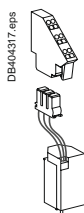

			Closing release	Opening release
Standard	AC 50/60 Hz DC	12 V DC	XF	MX
		24/30 V DC, 24 V AC	47349	47359
		48/60 V DC, 48 V AC	47350	47360
		100/130 V AC/DC	47351	47361
		200/250 V AC/DC	47352	47362
		277 V AC	47353	47363
		380/480 V AC	47354	47364
		380/480 V AC	47355	47365
Communicating	AC 50/60 Hz DC	12 V DC	XF com	MX com
		24/30 V DC, 24 V AC	47310	47320
		48/60 V DC, 48 V AC	47311	47321
		100/130 V AC/DC	47312	47322
		200/250 V AC/DC	47313	47323
		277 V AC	47314	47324
		380/480 V AC	47315	47325
		380/480 V AC	47316	47326

“Ready to close” contact (1 max.)

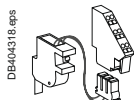

		PF
	1 changeover contact (5 A - 240 V)	47342
	1 low-level changeover contact	47343

Electrical closing pushbutton

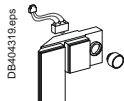

		BPFE
	1 pushbutton	48534

Remote reset after fault trip

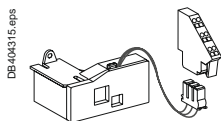

		RES
Electrical reset	110/130 V AC	48202
	220/240 V AC	48203
Automatic reset		RAR
Adaptation		47346

Remote tripping

Instantaneous voltage release

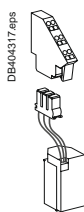

		2 nd MX	or	MN
AC 50/60 Hz	12 V DC	47369		
	24/30 V DC, 24 V AC	47370		47380
	48/60 V DC, 48 V AC	47371		47381
	100/130 V AC/DC	47372		47382
	200/250 V AC/DC	47373		47383
	277 V AC	47374		
DC	380/480 V AC	47375		47385

MN delay unit

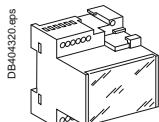

		R (non-adjustable)	Rr (adjustable)
AC 50/60 Hz	48/60 V AC/DC		33680
	100/130 V AC/DC	33684	33681
	200/250 V AC/DC	33685	33682
	380/480 V AC/DC		33683



NW10 DC to NW40 DC drawout circuit breakers

Indication contacts

ON/OFF indication contacts (OF)

DB404321.eps

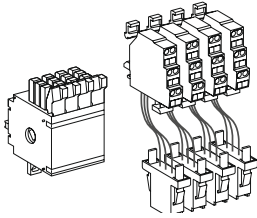

Block of 4 changeover contacts (6 A - 240 V)	1 block (standard)
1 additional block of 4 contacts (2 max.)	48468

Combined closed / connected contacts for use with 1 auxiliary contact

DB404322.eps

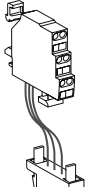

1 contact (5 A - 240 V) (8 max.)	48477
or 1 low-level contact (8 max.)	48478

"Fault trip" indication contacts (SDE)

DB404323.eps

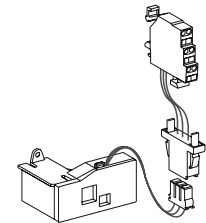

Changeover contact (5 A - 240 V)	1 (standard)
1 additional SDE (5 A - 240 V)	48475
or 1 additional low-level SDE	48476

Carriage switches (connected / disconnected / test position)

DB404324.eps

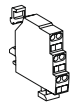

Changeover contacts (8 A - 240V)	
1 connected position contact (3 max.)	33751
1 test position contact (3 max.)	33752
1 disconnected position contact (3 max.)	33753
and/or low-level changeover contacts	
1 connected position contact (3 max.)	33754
1 test position contact (3 max.)	33755
1 disconnected position contact (3 max.)	33756
Actuator for additional carriage switches	48560

NW10 DC to NW40 DC drawout circuit breakers (cont.)

Chassis locking and accessories

Chassis locking

"Disconnected" position locking

DB404326.eps

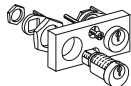

By padlocks		VPOC	Standard
By Profalux keylocks			
Profalux	1 lock with 1 key + adaptation kit		48568
	2 locks 1 key + adaptation kit		48569
	2 locks 2 different keys + adaptation kit		48570
1 keylock Profalux (without adaptation kit):	Identical key not identified combination		33173
	Identical key identified 215470 combination		33174
	Identical key identified 215471 combination		33175
By Ronis keylocks			
Ronis	1 lock with 1 key + adaptation kit		48572
	2 locks 1 key + adaptation kit		48573
	2 locks 2 different keys + adaptation kit		48574
1 keylock Ronis (without adaptation kit):	Identical key not identified combination		33189
	Identical key identified EL24135 combination		33190
	Identical key identified EL24153 combination		33191
	Identical key identified EL24315 combination		33192
Optional disconnected/test/connected position locking			33779
Adaptation kit (without keylock): Adaptation kit Profalux / Ronis			48564
Adaptation kit Kirk			48565
Adaptation kit Castell			48566

Door interlock (1 part)

DB404326.eps

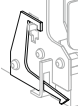

Right-hand side of chassis	48579
Left-hand side of chassis	48580

Racking interlock

DB404327.eps

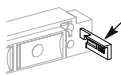

1 part	48582
--------	--------------

Racking interlock between crank and OFF pushbutton

1 part	48585
--------	--------------

Automatic spring discharge before breaker removal

1 part	48554
--------	--------------

DB404328.eps



Breaker mismatch protection

DB404329.eps



Breaker mismatch protection V DC	33767
----------------------------------	--------------

Chassis accessories

Arc chute cover

DB404330.eps

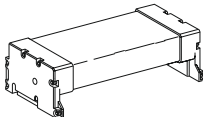

3P/4P	Standard
-------	----------

Auxiliary terminal shield (CB)

DB404331.eps

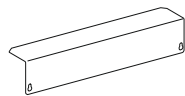

1000/4000 A	3P	48595
	4P	48596

Safety shutters + locking block

DB404332.eps

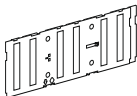

1000/4000 A	3P	Standard
	4P	Standard

Shutter locking block (for replacement)

DB404333.eps



2 parts for 1000/4000 A	48591
-------------------------	--------------

Front face shutter position indication and locking

1000/4000 A	3P/4P	48592
-------------	-------	--------------



NW10 DC to NW40 DC drawout circuit breakers

Remote operation

Remote ON/OFF

Gear motor

DB404334.eps

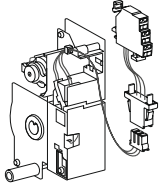

			MCH
AC 50/60 Hz	48 V		48522
	100/130 V		48526
	200/240 V		48527
	250/277 V		48528
	380/415 V		48529
	440/480 V		48530
DC	24/30 V		48521
	48/60 V		48522
	100/130 V		48523
	200/250 V		48524

Instantaneous voltage releases

DB404335.eps

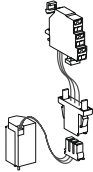

			Closing release	Opening release
Standard	AC 50/60 Hz DC	12 V DC	XF	MX
		24/30 V DC, 24 V AC	48480	48490
		48/60 V DC, 48 V AC	48481	48491
		100/130 V AC/DC	48482	48492
		200/250 V AC/DC	48483	48493
		277 V AC	48484	48494
		380/480 V AC	48485	48495
Communicating	AC 50/60 Hz DC	12 V DC	48486	48496
		24/30 V DC, 24 V AC	XF com	MX com
		48/60 V DC, 48 V AC	48448	48457
		100/130 V AC/DC	48449	48458
		200/250 V AC/DC	48450	48459
		277 V AC	48451	48460
		380/480 V AC	48452	48461
		48453	48462	
		48454	48463	

"Ready to close" contact (1 max.)

DB404336.eps

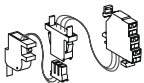

		PF
1 changeover contact (5 A - 240 V) 1 low-level changeover contact		48469
		48470

Electrical closing pushbutton

DB404319.eps

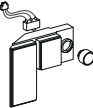

		BPFE
1 pushbutton		48534

Remote reset after fault trip

DB404323.eps

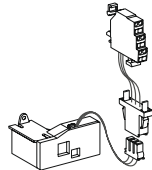

Electrical reset	110/130 V AC	RES
	220/240 V AC	48472
Automatic reset		48473
		RAR
Adaptation		47346

Remote tripping

Instantaneous voltage release

DB404335.eps

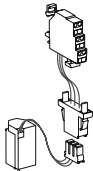

			2 nd MX	or	MN
AC 50/60 Hz DC	12 V DC		48510		
	24/30 V DC, 24 V AC		48511		48501
	48/60 V DC, 48 V AC		48512		48502
	100/130 V AC/DC		48513		48503
	200/250 V AC/DC		48514		48504
	277 V AC		48515		
	380/480 V AC		48516		48506

MN delay unit

DB404320.eps

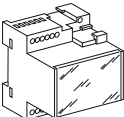

			R (non-adjustable)	Rr (adjustable)
AC 50/60 Hz DC	48/60 V AC/DC			33680
	100/130 V AC/DC		33684	33681
	200/250 V AC/DC		33685	33682
	380/480 V AC/DC			33683

Accessories for NW10 DC to NW40 DC fixed and drawout circuit breakers

Circuit breaker locking

Pushbutton locking device

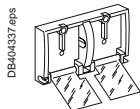

By padlocks	48536
-------------	--------------

OFF position locking

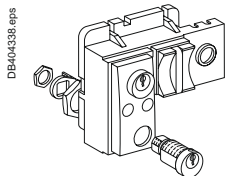

By padlocks		
	VPOC	48539
By Profalux keylocks		
Profalux	1 lock with 1 key + adaptation kit	48545
	2 locks 1 key + adaptation kit	48546
	2 locks 2 different keys + adaptation kit	48547
	1 keylock Profalux (without adaptation kit)	33173
	Identical key not identified combination	33174
	Identical key identified 215470 combination	33175
	Identical key identified 215471 combination	33175
By Ronis keylocks		
Ronis	1 lock with 1 key + adaptation kit	48549
	2 locks 1 key + adaptation kit	48550
	2 locks 2 different keys + adaptation kit	48551
	1 keylock Ronis (without adaptation kit)	33189
	Identical key not identified combination	33190
	Identical key identified EL24135 combination	33191
	Identical key identified EL24153 combination	33191
	Identical key identified EL24315 combination	33192
Adaptation kit (without keylock):	Adaptation kit Profalux / Ronis	48541
	Adaptation kit Kirk	48542
	Adaptation kit Castell	48543

Other circuit breaker accessories

Mechanical operation counter

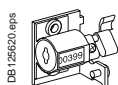

Operation counter CDM	48535
-----------------------	--------------

Escutcheon and accessories

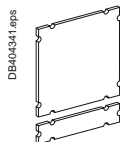
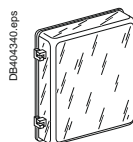
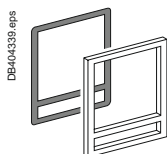

	Fixed	Drawout
Escutcheon	48601	48603
Transparent cover IP54		48604
Escutcheon blanking plate	48605	48605

Escutcheon.

Cover.

Blanking plate.



Spare parts: Masterpact NW DC - DC PV Connection

Connection

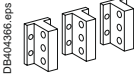
Fixed or drawout circuit breakers or switches		C or D type	E type	
Rear connection (vertical or horizontal mounting) / Replacement kit (3 or 4 parts)				
	1000/2000 A	Vertical or horizontal Top or bottom	47966	47967
	4000 A	Vertical or horizontal Top or bottom	47968	47969

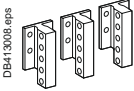

Vertical mounting

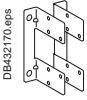

Connection accessories

Additional support brackets for mounting on a backplate			
	For fixed rear-connected circuit breaker (2 parts)		47829

Spare parts: Masterpact NW DC - DC PV Remote operation

Remote operation

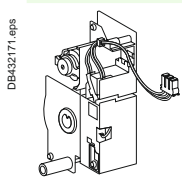

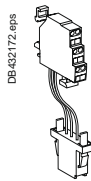
Gear motor

	MCH (1 part)		
	AC 50/60 Hz	48 V	47889
		100/130 V	47893
		200/240 V	47894
		250/277 V	47895
		380/415 V	47896
		440/480 V	47897
	DC	24/30 V	47888
		48/60 V	47889
		100/125 V	47890
200/250 V		47891	
Terminal block (1 part)	For fixed circuit breaker	47074	
	For drawout circuit breaker	47849	
		Installation manual	47951

Fixed.

Drawout.

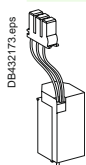

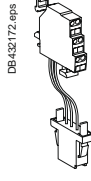
Closing and opening release (XF or MX)

	Standard coil (1 part)			
	AC 50/60 Hz	12 V DC	33658	
		24/30 V DC, 24 V AC	33659	
		48/60 V DC, 48 V AC	33660	
		100/130 V AC/DC	33661	
		200/250 V AC/DC	33662	
		277 V AC	33663	
	DC	380/480 V AC	33664	
		Communicating coil (1 part)		
		12 V DC	33032	
24/30 V DC, 24 V AC		33033		
DC	48/60 V DC, 48 V AC	33034		
	100/130 V AC/DC	33035		
	200/250 V AC/DC	33036		
	277 V AC	33037		
	380/480 V AC	33038		
	Terminal block (1 part)	For fixed circuit breaker	47074	
	For drawout circuit breaker	47849		
		Installation manual	47951	

Fixed.

Drawout.

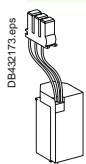
Undervoltage release MN

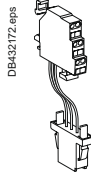
	Undervoltage release (1 part)			
	AC 50/60 Hz	24/30 V DC, 24 V AC	33668	
		48/60 V DC, 48 V AC	33669	
		100/130 V AC/DC	33670	
		200/250 V AC/DC	33671	
		380/480 V AC	33673	
		Terminal block (1 part)	For fixed circuit breaker	47074
		For drawout circuit breaker	47849	
			Installation manual	47951

Fixed.

Drawout.

MN delay unit

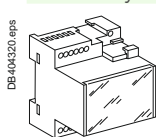
	MN delay unit (1 part)			
	AC 50/60 Hz		R (non-adjustable)	R (adjustable)
		48/60 V AC/DC		33680
		100/130 V AC/DC	33684	33681
		200/250 V AC/DC	33685	33682
		380/480 V AC/DC		33683
DC			47951	
Installation manual			47951	



Spare parts: Masterpact NW DC - DC PV

Chassis locking and accessories

Chassis locking

"Disconnected" position locking / 1 part

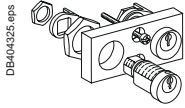

DB404325.eps

By padlocks

VCPO	Standard
------	----------

By Profalux keylocks

Profalux	1 lock with 1 key + adaptation kit	64934
	2 locks 1 key + adaptation kit	64935
	2 locks 2 different keys + adaptation kit	64936
1 keylock Profalux (without adaptation kit):	identical key not identified combination	33173
	identical key identified 215470 combination	33174
	identical key identified 215471 combination	33175

By Ronis keylocks

Ronis	1 lock with 1 key + adaptation kit	64937
	2 locks 1 key + adaptation kit	64938
	2 locks 2 different keys + adaptation kit	64939
1 keylock Ronis (without adaptation kit):	identical key not identified combination	33189
	identical key identified EL24135 combination	33190
	identical key identified EL24153 combination	33191
	identical key identified EL24315 combination	33192
Adaptation kit (without keylock):	adaptation kit Profalux / Ronis	48564
	adaptation kit Kirk	48565
	adaptation kit Castell	48566
Installation manual		47952

Door interlock / 1 part

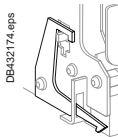

DB432174.eps

Right and left-hand side of chassis (VPECD or VPECG)	47914
--	-------

Installation manual	47952
---------------------	-------

Racking interlock

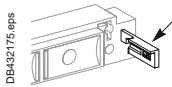

DB432175.eps

5 parts	64940
---------	-------

Installation manual	47952
---------------------	-------

Breaker mismatch protection / 1 part

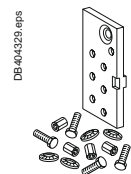

DB-404329.eps

Breaker mismatch protection (VDC)	33767
-----------------------------------	-------

Installation manual	47952
---------------------	-------

Chassis accessories

Auxiliary terminal shield (CB) / 1 part

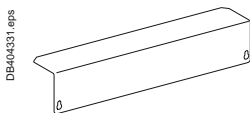

DB404331.eps

800/4000 A	3P	64942
	4P	48596
4000b/6300 A	3P	48597
	4P	48598

Safety shutters + locking block / 1 part

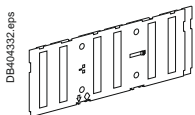

DB404332.eps

800/4000 A	3P	48721
	4P	48723
4000b/6300 A	3P	48722
	4P	48724
Installation manual		47952

Shutter locking block (for replacement) / 1 part

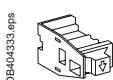

DB404333.eps

2 parts for 800/4000 A	48591
------------------------	-------

Installation manual	47952
---------------------	-------

Earthing kit for chassis

3P	4P
----	----

Types for N1/H1/NA/HA

48433	48434
-------	-------

Note: the installation manual is enclosed.

Spare parts: Masterpact NW DC - DC PV Clusters

Clusters

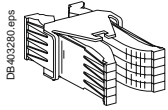

1 disconnecting contact cluster for chassis (see table below) (part 1) **64906**

Table : number of clusters required for the different chassis models

Chassis rating (A)	Masterpact NW 3P				Masterpact NW 4P			
	N1	H1/H2	H3	L1	N1	H1/H2	H3	L1
250		12 (H1)						
630	6	12		24	8	16		32
800	6	12		24	8	16		32
1000	6	12		24	8	16		32
1250	6	12		24	8	16		32
1600	12	12		24	16	16		32
2000		24	24	42		32	32	56
2500		24	24			32	32	
3200		36	36			48	48	
4000		42	42			56	56	
4000b		72				96		
5000		72				96		
6300		72				96		

Note: the minimum order is 6 parts.

Racking handle

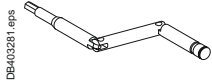

Racking handle **47944**

DC rear connection

Serial connection kit

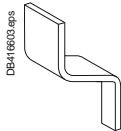

For NW10/20 DC **48642**

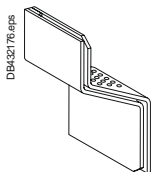

For NW40 DC **48643**



Spare parts: Masterpact NW DC - DC PV

Circuit breaker locking and accessories

Circuit breaker locking

Pushbutton locking device / 1 part

DB40437.eps

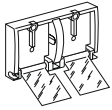

By padlocks	48536
-------------	--------------

Installation manual	47951
---------------------	--------------

OFF position locking / 1 part

DB404411.eps

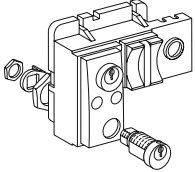

By padlocks	48539
-------------	--------------

By Profalux keylocks

Profalux	1 lock with 1 key + adaptation kit	64928
	2 locks 1 key + adaptation kit	64929
	2 locks 2 different keys + adaptation kit	64930
1 keylock Profalux (without adaptation kit):	identical key not identified combination	33173
	identical key identified 215470 combination	33174
	identical key identified 215471 combination	33175

By Ronis keylocks

Ronis	1 lock with 1 key + adaptation kit	64931
	2 locks 1 key + adaptation kit	64932
	2 locks 2 different keys + adaptation kit	64933
1 keylock Ronis (without adaptation kit):	identical key not identified combination	33189
	identical key identified EL24135 combination	33190
	identical key identified EL24153 combination	33191
	identical key identified EL24315 combination	33192
	Adaptation kit (without keylock):	adaptation kit Profalux / Ronis
	adaptation kit Kirk	64927
	adaptation kit Castell	64926
Installation manual		47951

Other circuit breaker accessories

Mechanical operation counter / 1 part

DB128617.eps



Operation counter CDM	48535
-----------------------	--------------

Installation manual	47951
---------------------	--------------

Escutcheon and accessories / 1 part

DB432177.eps

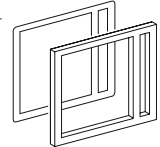

DB403098.eps



DB403099.eps

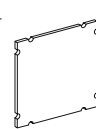

	Fixed	Drawout
Escutcheon	48601	48603
Transparent cover (IP 54)		48604
Escutcheon blanking plate	48605	48605

Escutcheon	Cover	Blanking plate	Installation manual	47951
------------	-------	----------------	---------------------	--------------

Spring charging handle / 1 part

DB404413.eps



Spring charging handle	47940
------------------------	--------------

Installation manual	47951
---------------------	--------------

Arc chute for Masterpact NW / 1 part

DB432178.eps

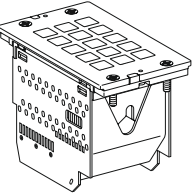

Type NW DC	C type	D type	E type
2 x	47934	3 x 47934	4 x 47934

Installation manual	47951
---------------------	--------------

F

Spare parts: Masterpact NW DC - DC PV

Mechanical interlocking for source changeover

Cable-type door interlock

1 complete assembly for Masterpact NW fixed or drawout device

48614

Note: the installation manual is enclosed.

Spare parts: Masterpact NW DC - DC PV

Indication contacts

Indication contacts

ON/OFF indication contacts (OF) / 12 parts

DB432179.eps

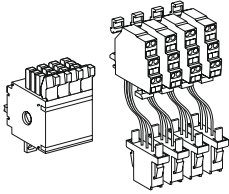

1 additional block of 4 contacts		64922
Wiring	For fixed circuit breaker	47074
	For drawout circuit breaker	47849

Installation manual		47951
---------------------	--	--------------

"Fault trip" indication contacts (SDE) / 1 part

DB432190.eps

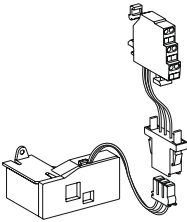

Changeover contact (SDE)	6 A - 240 V	47915
	Low-level	47916
Wiring	For fixed circuit breaker	47074
	For drawout circuit breaker	47849

Installation manual		47951
---------------------	--	--------------

"Ready to close" contact (1 max.) / 1 part

DB432181.eps



1 changeover contact (5 A - 240 V)		47080
1 low-level changeover contact		47081
Wiring	For fixed circuit breaker	47074
	For drawout circuit breaker	47849

Installation manual		47951
---------------------	--	--------------

"Connected, disconnected, test position" indication contact (carriage switches) / 1 part

DB404324.eps

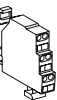

Changeover contacts	6 A - 240 V	33170
CE, CD, CT	Low-level	33171

Installation manual		47952
---------------------	--	--------------

Set of additional actuaters for carriage switches / 1 set

1 set		48560
-------	--	--------------

F

Combined closed / connected contacts for use with 1 auxiliary contact / 1 part

DB432172.eps

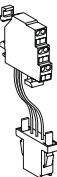

1 contact (5 A - 240 V)		48477
or 1 low-level contact		48478

Installation manual		47952
---------------------	--	--------------

Electrical closing pushbutton / 1 part

DB432182.eps

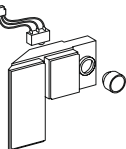

1 pushbutton		48534
--------------	--	--------------

Installation manual		47951
---------------------	--	--------------

Auxiliary terminals for chassis alone

3 wire terminal (1 part)		47849
6 wire terminal (1 part)		47850
Jumpers (10 parts)		47900

Catalogue numbers: spare parts
Spare parts: Masterpact NW DC
- DC PV
Instructions

Instructions

Chassis accessories		47952
Circuit breaker accessories		47951
Fixed and drawout circuit breaker		47950
User manual	NW DC (French)	64923
	NW DC (English)	64924
Modbus communication notice for manual		33088



Spare parts: Masterpact NW DC - DC PV Monitoring and control converter

Monitoring and control

ULP display module



Switchboard front display module FDM121	TRV00121
FDM mounting accessory (diameter 22 mm)	TRV00128

ULP wiring accessories

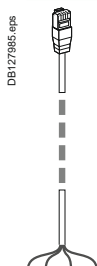

Breaker ULP cord L = 0.35 m	LV434195
Breaker ULP cord L = 1.3 m	LV434196
Breaker ULP cord L = 3 m	LV434197

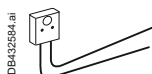

2 Modbus line terminators	VW3A8306DRC ^[1]
---------------------------	-----------------------------------



5 RJ45 connectors female/female	TRV00870
---------------------------------	-----------------



10 ULP line terminators	TRV00880
-------------------------	-----------------



10 RJ45/RJ45 male cord L = 0.3 m	TRV00803
10 RJ45/RJ45 male cord L = 0.6 m	TRV00806
5 RJ45/RJ45 male cord L = 1 m	TRV00810
5 RJ45/RJ45 male cord L = 2 m	TRV00820
5 RJ45/RJ45 male cord L = 3 m	TRV00830
1 RJ45/RJ45 male cord L = 5 m	TRV00850

[1] www.schneider-electric.com.

Compact NSX100 DC to NSX250 DC circuit breakers

Check the applicable and enter the appropriate
square boxes information in the rectangles

Circuit breaker Quantity
Compact type **NSX100/160/250**

Rating **A**

Circuit breaker **F, N, M, S**

Number of poles **1 or 2**

Circuit breaker **DC**

Number of poles **3 or 4**

Number of poles tripped **3d or 4d**

Fixed device Front conn. Long rear conn.

Short rear conn.

Plug-in/withdr. Plug-in Withdrawable

Thermal-magnetic trip unit

Thermal-magnetic TMD rating (16...63 A)

NSX100 to 250 TMG rating (16...250 A)

TMDC rating (80...250 A)

Special connection accessories for parallel or series connection

Series connection 2 poles (1 connection plate)

3 poles (2 connection plates)

4 poles (3 connection plates)

Parallel connection 2 poles (2 connection plates)

3 poles (NSX100 to 250, 1 set of 2 connection plates)

2 x 2 poles (4 connection plates)

Special terminal shields for parallel or series connection

1P short 1 pair

2P short 2 x 1 pair (1P)

3P short for series connection of poles 1 set

4P short for series connection of poles 1 set

4P short for parallel connection of poles (2P/4P) 1 set

Connection

NSX100/250 Steel 1.5° to 95° (< 160 A)

connectors Aluminium 25° to 95° (< 250 A)

Aluminium 120° to 185° (< 250 A)

Voltage measurement For bare cable NSX100/250

input connector ≤ 185°

Right-angle terminal extensions

Straight extensions NSX100/250

Double L terminal extension 3P 4P

Spreader from 35 to 45 mm 3P 4P

One piece spreader

Front alignment

Cu cable lugs NSX100/250 120° 150° 185°

240° 300°

Al cable lugs NSX100/250 150° 185°

240° 300°

Insulation screen 45 mm 3P 4P

70 mm 3P 4P

Interphase barriers Set of 6

Indication and measurements

Auxiliary contact OF SD SDE Standard Low level

SDE adapter (TM trip unit)

Remote operation

Electrical operation Motor mechanism AC DC V

Voltage releases Instantaneous MX AC DC V

MN AC DC V

Fixed time delay MN AC DC V

Adjust. time delay MN AC DC V

Rotary handles

Direct Black Red on yellow front

MCC conversion access. CNOMO conversion access.

Extended Black Red on yellow front

Telescopic handle for withdrawable device

Indication auxiliary 1 early-break switch 2 early-break switches

Wiring accessory for early-make switches

Locking

Toggle (1 to 3 padlocks) Removable Fixed Open/Close

Fixed Open

Rotary handle Keylock adapter (keylock not included)

Keylock Ronis 1351B.500 Profalux KS5 B24 D4Z

Motor mechanism Keylock adapter + Keylock Ronis (special) NSX100/250

Keylock Ronis 1351B.500 Profalux KS5 B24 D4Z

Interlocking

Mechanical Toggle Rotary handle

By key (2 Keylocks, 1 key) Keylock adapter (keylock not included)

For rotary handle Keylock Ronis 1351B.500 Profalux KS5 B24 D4Z

Installation accessories

Front-panel escutcheon Toggle

Rotary handle, motor mechanism, escutcheon collar; IP40

Toggle cover

Sealing accessories

DIN rail adapter NSX100/250

Plug-in / Drawout configuration accessories

Auxiliary connections 1 automatic connector fixed part with 9 wires (for base)

1 auto. conn. moving part with 9 wires (for circuit breaker)

1 support for 3 automatic connector moving parts

9-wire manual auxiliary connector (fixed + moving)

Plug-in base accessories Long insulated terminals Set of 3 Set of 4

2 IP4 shutters for base

Chassis accessories Escutcheon collar Toggle

Locking kit (keylock not included)

2 carriage switches (conn./disconnected position indication)

Parts of plug-in Plug-in base FC/RC 2P 3P 4P

Set of 2 power connections Standard

Safety trip for advanced opening

For 3P/4P chassis Moving part

Fixed part

Communication

NSX Cord L = 0.35 m NSX Cord L = 1.3 m

NSX Cord U > 480 V AC L = 0.35 m NSX Cord L = 3 m

BSCM

Communicating motor mechanism 220-240 V

Switchboard front display module FDM121

FDM mounting accessory

Ethernet interface + gateway

Ethernet interface

Modbus interface

I/O application module Qty 1 Qty 2

Stacking accessory

ULP line termination

RJ45 connectors female/female Wire length RJ45 Wire length RJ45

L = 0.3 m L = 0.6 m

Wire length RJ45 Wire length RJ45

L = 1 m L = 2 m

Wire length RJ45 Wire length RJ45

L = 3 m L = 5 m



Compact NSX400 DC to NSX630 DC

Circuit breakers and switch-disconnectors

Check the applicable and enter the appropriate information in the rectangles

Quantity

Circuit breaker / Switch-disconnector Compact type **NSX400/630**

switch-disconnector circuit breaker

Rating **A**

Circuit breaker **F, S**

DC

Number of poles **3 or 4**

Fixed device Front conn. Long rear conn.

Short rear conn.

Plug-in/withdr. Plug-in Withdrawable

Circuit breaker thermal-magnetic trip unit **Thermal-magnetic TM-DC** rating (250...600 A)

Special connection accessories for parallel or series connection

Series connection 2 poles (1 connection plate)

3 poles (2 connection plates)

4 poles (3 connection plates)

Parallel connection 2 poles (2 connection plates)

2 x 2 poles (4 connection plates)

Special terminal shields for parallel or series connection

Terminal shield for front connection

Terminal shield for rear connection Standard Short

Connection

NSX400/630 connectors 1 cable 35² to 300²

2 cables 35² to 240²

Voltage measurement input For bare cable connector

Right-angle terminal extensions

Edgewise extensions

Double L terminal extension 3P 4P

Spreader from 35 to 45 mm 3P 4P

One piece spreader

Front alignment

Cu cable lugs NSX400/630 120² 150² 185²

240² 300²

Al cable lugs NSX400/630 150² 185²

240² 300²

Insulation screen 45 mm 3P 4P

70 mm 3P 4P

Interphase barriers Set of 6

Indication and measurements

Auxiliary contact OF SD SDE Standard Low level

SDE adapter (TM trip unit)

Remote operation

Electrical operation Motor mechanism AC DC V

Voltage releases Instantaneous MX AC DC V

MN AC DC V

Fixed time delay MN AC DC V

Adjust. time delay MN AC DC V

Rotary handles

Direct Black Red on yellow front

MCC conversion access. CNOMO conversion access.

Extended Black Red on yellow front

Telescopic handle for withdrawable device

Indication auxiliary 1 early-break switch 2 early-break switches

Wiring accessory for early-make switches

Locking

Toggle (1 to 3 padlocks) Removable Fixed Open/Close

Fixed Open

Rotary handle Keylock adapter (keylock not included)

Keylock Ronis 1351B.500 Profalux KS5 B24 D4Z

Motor mechanism Keylock adapter (keylock not included) NSX400/630

Keylock Ronis 1351B.500 Profalux KS5 B24 D4Z

Interlocking

Mechanical Toggle Rotary handle

By key (2 Keylocks, 1 key) Keylock adapter (keylock not included)

For rotary handle Keylock Ronis 1351B.500 Profalux KS5 B24 D4Z

Installation accessories

Front-panel escutcheon Toggle

Rotary handle, motor mechanism, escutcheon collar; IP40

Toggle cover

Sealing accessories

Plug-in / Drawout configuration accessories

Auxiliary connections 1 automatic connector fixed part with 9 wires (for base)

1 auto. conn. moving part with 9 wires (for circuit breaker)

1 support for 3 automatic connector moving parts

9-wire manual auxiliary connector (fixed + moving)

Plug-in base accessories Long insulated terminals Set of 3 Set of 4

2 IP4 shutters for base

Chassis accessories Escutcheon collar Toggle

Locking kit (keylock not included)

2 carriage switches (conn./disconnected position indication)

Parts of plug-in Plug-in base FC/RC 2P 3P 4P

Set of 2 power connections Standard

Safety trip for advanced opening

For 3P/4P chassis Moving part

Fixed part

Communication

NSX Cord L = 0.35 m NSX Cord L = 1.3 m

NSX Cord U > 480 V AC L = 0.35 m NSX Cord L = 3 m

BSCM

Communicating motor mechanism 220-240 V

Switchboard front display module FDM121

FDM mounting accessory

Ethernet interface + gateway

Ethernet interface

Modbus interface

I/O application module Qty 1 Qty 2

Stacking accessory

ULP line termination

RJ45 connectors female/female Wire length RJ45 L = 0.3 m Wire length RJ45 L = 0.6 m

Wire length RJ45 L = 1 m Wire length RJ45 L = 2 m

Wire length RJ45 L = 3 m Wire length RJ45 L = 5 m



Compact NSX1200 DC circuit breakers

Check the applicable and enter the appropriate square boxes information in the rectangles

Circuit breaker Rating **630A, 800 A, 1000 A, 1200 A** Quantity

Fixed device Without bare cable connector
With bare cable connector

Connection Voltage measurement input For bare cable connector

Indication auxiliaries

Auxiliary contact OF SD SDE Standard Low level

SDE adapter (TM trip unit)

Remote operation

Electrical operation Motor mechanism AC DC V

Voltage releases Instantaneous MX AC DC V

MN AC DC V

Fixed time delay MN AC DC V

Adjust. time delay MN AC DC V

Rotary handles

Direct Black Red on yellow front

MCC conversion access. CNOMO conversion access.

Extended Black Red on yellow front

Telescopic handle for withdrawable device

Indication auxiliary 1 early-break switch 2 early-break switches

Wiring accessory for early-make switches

Locking

Toggle (1 to 3 padlocks) Removable Fixed Open/Close

Fixed Open

Rotary handle Keylock adapter (keylock not included)

Keylock Ronis 1351B.500 Profalux KS5 B24 D4Z

Motor mechanism Keylock adapter (keylock not included) NSX400/630

Keylock Ronis 1351B.500 Profalux KS5 B24 D4Z

Interlocking

Mechanical Toggle Rotary handle

By key (2 Keylocks, 1 key) Keylock adapter (keylock not included)

For rotary handle Keylock Ronis 1351B.500 Profalux KS5 B24 D4Z

Installation accessories

Front-panel escutcheon Toggle

Rotary handle, motor mechanism, escutcheon collar; IP40

Toggle cover

Sealing accessories

Communication

NSX Cord L = 0.35 m NSX Cord L = 1.3 m

NSX Cord U > 480 V AC L = 0.35 m NSX Cord L = 3 m

BSCM

Communicating motor mechanism 220-240 V

Switchboard front display module FDM121

FDM mounting accessory

Ethernet interface + gateway

Ethernet interface

Modbus interface

I/O application module Qty 1 Qty 2

Stacking accessory

ULP line termination

RJ45 connectors female/female Wire length RJ45 Wire length RJ45

L = 0.3 m L = 0.6 m

Wire length RJ45 Wire length RJ45

L = 1 m L = 2 m

Wire length RJ45 Wire length RJ45

L = 3 m L = 5 m



Compact NSX80/500 TM DC PV to NSX100/500 NA DC PV

Circuit breakers and switch-disconnectors

Check the applicable and enter the appropriate square boxes information in the rectangles

Circuit breaker	Quantity
Compact type	
NSX80 TM DC PV	
NSX125 TM DC PV	
NSX160 TM DC PV	
NSX200 TM DC PV	
NSX250 TM DC PV	
NSX320 TM DC PV	
NSX400 TM DC PV	
NSX500 TM DC PV	

Special connection and insulation accessories for circuit breakers (mandatory)

Upstream	connection plates with heatsink (x2)	
	special terminal shields	
Downstream	standard long terminal shields	
	or rear connections	short
		long
	+ short terminal shields	

Switch-disconnector	Quantity
Compact type	
NSX100 NA DC PV	
NSX160 NA DC PV	
NSX200 NA DC PV (160 A)	
NSX200 NA DC PV (200 A)	
NSX400 NA DC PV	
NSX500 NA DC PV	

Special connection and insulation accessories for switch-disconnectors (mandatory)

Upstream	connection plates with heatsink (x2)	
≤ 200 A at 40 °C	special terminal shields	
	or interphase barriers	
Upstream	connection plates with heatsink (x2)	
= 200 A at 55 °C	(long)	
	interphase barriers	
Upstream	connection plates with heatsink (x2)	
≥ 400 A	special terminal shields	
	or interphase barriers	
Downstream	standard long terminal shields	
	or rear connections	short
		long
	+ short terminal shields	
	or interphase barriers	

Connection

NSX100/250 connectors	Steel 1.5° to 95° (< 160 A)	
	Aluminium 25° to 95° (< 250 A)	
	Aluminium 120° to 185° (< 250 A)	
NSX400/630 connectors	1 cable 35° to 300°	
	2 cables 35° to 240°	
Voltage measurement input	For bare cable connector	NSX100/250 ≤ 185°
	For bare cable connector	NSX400/630
Right-angle terminal extensions		
Straight extensions	NSX100/250	
Edgewise extensions	NSX400/630	
Double L terminal extension	3P	4P
Spreader from 35 to 45 mm	3P	4P
Cu cable lugs	NSX100/250 120°	150° 185°
	NSX400/630	240° 300°
Al cable lugs	NSX100/250	150° 185°
	NSX400/630	240° 300°
Insulation screen	45 mm	3P 4P
	70 mm	3P 4P
Interphase barriers		Set of 6

Indication auxiliaries	OF	SD	SDE	Standard	Low level
Auxiliary contact	<input type="checkbox"/>	<input type="checkbox"/>	<input type="checkbox"/>	<input type="checkbox"/>	<input type="checkbox"/>
SDE adapter (TM trip unit)					<input type="checkbox"/>

Remote operation					
Electrical operation	Motor mechanism	AC	DC	V	
Voltage releases	Instantaneous	MX	AC	DC	V
		MN	AC	DC	V
	Fixed time delay	MN	AC	DC	V
	Adjust. time delay	MN	AC	DC	V

Rotary handles			
Direct	Black	<input type="checkbox"/>	Red on yellow front
	MCC conversion access.	<input type="checkbox"/>	CNOMO conversion access.
Extended	Black	<input type="checkbox"/>	Red on yellow front
	Telescopic handle for withdrawable device		
Indication auxiliary	1 early-break switch	<input type="checkbox"/>	2 early-break switches
	Wiring accessory for early-make switches		

Locking		
Toggle (1 to 3 padlocks)	Removable	<input type="checkbox"/>
	Fixed Open/Close	<input type="checkbox"/>
	Fixed Open	<input type="checkbox"/>

Rotary handle	Keylock adapter (keylock not included)	
	Keylock Ronis 1351B.500	Profalux KS5 B24 D4Z
Motor mechanism	Keylock adapter + Keylock Ronis (special)	NSX100/250
	Keylock adapter (keylock not included)	NSX400/630
	Keylock Ronis 1351B.500	Profalux KS5 B24 D4Z

Interlocking		
Mechanical	Toggle	<input type="checkbox"/>
	Rotary handle	<input type="checkbox"/>
By key (2 keylocks, 1 key)	Keylock adapter (keylock not included)	
For rotary handle	Keylock Ronis 1351B.500	Profalux KS5 B24 D4Z

Installation accessories		
Front-panel escutcheon	Toggle	
	Rotary handle, motor mechanism, escutcheon collar; IP40	
Toggle cover		
Sealing accessories		
DIN rail adapter	NSX100/250	

Communication		
	NSX Cord L = 0.35 m	<input type="checkbox"/>
	NSX Cord U > 480 V AC L = 0.35 m	<input type="checkbox"/>
	NSX Cord L = 1.3 m	<input type="checkbox"/>
	NSX Cord L = 3 m	<input type="checkbox"/>

BSCM		
Communicating motor mechanism	220-240 V	
Switchboard front display module	FDM121	
FDM mounting accessory		
Ethernet interface + gateway		
Ethernet interface		
Modbus interface		
I/O application module	Qty 1	Qty 2
Stacking accessory		
ULP line termination		
RJ45 connectors female/female	<input type="checkbox"/>	
	Wire length RJ45 L = 0.3 m	Wire length RJ45 L = 0.6 m
	Wire length RJ45 L = 1 m	Wire length RJ45 L = 2 m
	Wire length RJ45 L = 3 m	Wire length RJ45 L = 5 m

Compact NSX630/1600 NA DC PV 4P, fixed version

Upside: front connection, 2 kit heatsink, phase separator
are included

Name of customer:
 Address for delivery:
 Requested delivery date:
 Customer order no:

To indicate your choices,
 Check the applicable square boxes and enter the appropriate information in the rectangles

Switch-disconnector Quantity
 Rating A

Communication

COM module Device with Ethernet interface
 (BCM-ULP) with Ethernet interface + gateway
 with Modbus interface

Front Display Module (FDM121) Mounting accessory

Breaker ULP Cord L = 0.35 m
 L = 1.3 m
 L = 3 m

AD - external power-supply module V

NSX630b/1600 DC PV connection

Horizontal rear connections Bottom
 Vertical rear connections Bottom
 Front connections Bottom
 4 x 240° + bare cable connectors + shields Bottom
 Vertical-connection adapters Bottom
 Cable-lug adapters Bottom
 Long connection shields ^[1] Top Bottom
 or interphase barriers Bottom

[1] Bottom long connection shield or Bottom interphase barriers kit is mandatory.

Indication contacts

OF - ON/OFF indication contacts (maximum 3)
 6 A-240 V AC qty Low level qty

Remote operation

Electrical operation (NSX 630b/1600 DC PV)	Standard	<input type="checkbox"/>	Communicating	<input type="checkbox"/>
Power supply	AC	<input type="checkbox"/>	DC	<input type="checkbox"/>
Voltage releases	MX	AC	DC	V <input type="checkbox"/>
	MN	AC	DC	V <input type="checkbox"/>
MN delay unit		Adjustable	Non-adjustable	<input type="checkbox"/>

Locking

For electrically operated devices (NSX630b/1600 DC PV)

VBP - ON/OFF pushbutton locking (by transparent cover + padlocks)

OFF position locking:

VCPO - by padlocks

VSPO - by keylocks:

Keylock kit (w/o keylock)	Profalux	<input type="checkbox"/>	Ronis	<input type="checkbox"/>
1 keylock	Profalux	<input type="checkbox"/>	Ronis	<input type="checkbox"/>
2 identical keylocks, 1 key	Profalux	<input type="checkbox"/>	Ronis	<input type="checkbox"/>

Accessories

CDM - mechanical operation counter
 CDP - escutcheon
 CP - transparent cover for escutcheon
 OP - blanking plate for escutcheon



Masterpact NW DC

Name of customer:
 Address for delivery:
 Requested delivery date:
 Customer order no.:

To indicate your choices, check the applicable square boxes
 and enter the appropriate information in the rectangles

Circuit breaker or switch-disconnector		
Qty		
Masterpact type	NW10	<input type="checkbox"/>
	NW20	<input type="checkbox"/>
	NW40	<input type="checkbox"/>
Circuit breaker	N, H	<input type="checkbox"/>
Special PV switch-disconnectors	HADCD-PV (NW20 or NW40)	<input type="checkbox"/>
Switch-disconnector	HA	<input type="checkbox"/>
Sensor version	1250 to 2500 A	<input type="checkbox"/>
	2500 to 5400 A	<input type="checkbox"/>
	5000 to 11000 A	<input type="checkbox"/>
Version	C, D, E	<input type="checkbox"/>
Type of equipment	Fixed	<input type="checkbox"/>
	Drawout chassis	<input type="checkbox"/>

Communication	
COM module	
Device (BCM-ULP)	<input type="checkbox"/> with Ethernet interface <input type="checkbox"/> Cradle management <input type="checkbox"/> with Ethernet interface + gateway <input type="checkbox"/> application module (Chassis) <input type="checkbox"/> with Modbus interface <input type="checkbox"/>
Front Display Module FDM121	<input type="checkbox"/> Mounting accessory <input type="checkbox"/>
Breaker ULP Cord	L = 0.35 <input type="checkbox"/> L = 1.3 <input type="checkbox"/> L = 3 m <input type="checkbox"/>

Connection	
Vertical	Standard version Top <input checked="" type="checkbox"/> Bottom <input checked="" type="checkbox"/>
Horizontal	Vertical connection is standard however the connectors can be rotated on-site conversion to horizontal connection (except on the NW40)

Indication contacts

OF - ON/OFF indication contacts			
Standard	4 OF 10 A/240 V AC and low level		
Additional	1 block of 4 OF	Max. 2	Qty <input type="checkbox"/>

EF - combined "connected/closed" contacts			
	1 EF 6 A/240 V AC	Max. 8	Qty <input type="checkbox"/>
	1 EF low level	Max. 8	Qty <input type="checkbox"/>

SDE - "fault-trip" indication contact			
Standard	1 SDE 6 A/240 V AC	<input type="checkbox"/>	
Additional	1 SDE 6 A/240 V AC	<input type="checkbox"/>	1 SDE low level <input type="checkbox"/>

Carriage switches			
	Low level	<input type="checkbox"/>	6 A/240 V AC
CE - "connected" position	Max. 3		Qty <input type="checkbox"/>
CD - "disconnected" position	Max. 3		Qty <input type="checkbox"/>
CT - "test" position	Max. 3		Qty <input type="checkbox"/>
AC - NW actuator for 6 CE - 3 CD - 0 CT additional carriage switches			
			Qty <input type="checkbox"/>

Remote operation

Electrical operation			
MCH - gear motor		V	<input type="checkbox"/>
XF - closing voltage release		V	<input type="checkbox"/>
MX - opening voltage release		V	<input type="checkbox"/>
PF - "ready to close" contact	Low level		<input type="checkbox"/>
	6 A/240 V AC		<input type="checkbox"/>
BPFE - electrical closing pushbutton			<input type="checkbox"/>
RES - electrical reset option		V	<input type="checkbox"/>
RAR - automatic reset option			<input type="checkbox"/>
Remote tripping			
MN - undervoltage release		V	<input type="checkbox"/>
R - delay unit (non-adjustable)			<input type="checkbox"/>
Rr - adjustable delay unit			<input type="checkbox"/>
2° MX - shunt release		V	<input type="checkbox"/>

Locking

VBP - ON/OFF pushbutton locking (by transparent cover + padlocks)

OFF position locking:

VCPO - by padlocks			
VSPO - by keylocks	Keylock kit (w/o keylock)	Profalux	<input type="checkbox"/> Ronis <input type="checkbox"/>
	1 keylock	Profalux	<input type="checkbox"/> Ronis <input type="checkbox"/>
	2 identical keylocks, 1 key	Profalux	<input type="checkbox"/> Ronis <input type="checkbox"/>
	2 keylocks, different keys	Profalux	<input type="checkbox"/> Ronis <input type="checkbox"/>

Chassis locking in "disconnected" position:

VSPD - by keylocks	Keylock kit (w/o keylock)	Profalux	<input type="checkbox"/> Ronis <input type="checkbox"/>
		Kirk	<input type="checkbox"/> Castell <input type="checkbox"/>
	1 keylock	Profalux	<input type="checkbox"/> Ronis <input type="checkbox"/>
	2 identical keylocks, 1 key	Profalux	<input type="checkbox"/> Ronis <input type="checkbox"/>
	2 keylocks, different keys	Profalux	<input type="checkbox"/> Ronis <input type="checkbox"/>
	Optional connected/disconnected/test position locking		

VPEC - door interlock On right-hand side of chassis
 On left-hand side of chassis

VPOC - racking interlock

IPA - cable-type door interlock

VDC - mismatch protection

VIVC - shutter position indication and locking

IBPO - racking interlock between crank and OFF pushbutton for NW

DAE - automatic spring discharge before breaker removal for NW

Accessories

VO - safety shutters on chassis

GDM - mechanical operation counter

CB - auxiliary terminal shield for chassis

CDP - escutcheon

CP - transparent cover for escutcheon

OP - blanking plate for escutcheon

KMT - Grounding kit

F

Life Is On | **Schneider**
Electric

Schneider Electric Industries SAS

35, rue Joseph Monier
CS 30323
92506 Rueil Malmaison Cedex
France

RCS Nanterre 954 503 439
Capital social 896 313 776 €
www.schneider-electric.com

LVPED208006EN • WEB2 cat.2018

07/08/2018

© 2018 - Schneider Electric. All Rights Reserved.

All trademarks are owned by Schneider Electric Industries SAS or its affiliated companies.

This document has been
printed on recycled paper

