

3-Way Temperature Control Valve

Model G, Versions GEF, GPD and Accessories

Typical applications

For engines, turbines, gearboxes and heat exchangers:

- Charge air cooling
- Secondary cooling systems
- Fuel and lube oil preheating
- Co-generation
- Engine jacket water

For refineries, chemical plants and oil reproduction:

- Waste heat boilers
- Product coolers
- Product heaters
- Product condensers

Key benefits

- Ease of integration - valve size matches pipe size, resulting in reduced installation time and installation costs
- Flexible design - ports can be configured to suit installation
- Low pressure drop - compared to other valve types
- Small physical size
- Hand wheel allows manual adjustment of valve (optional on pneumatic valve) - simplified set up and maintenance

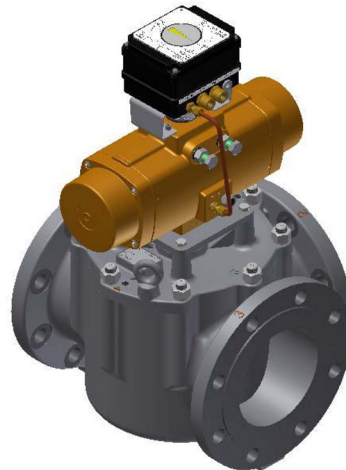

**Pneumatic
GPD Valve**



**Electric
GEF Valve**

Contents

Overview	3
Applications	3
System Types	4
Overview of Valve Body.....	6
Specification	6
Modes of Operation	7
Valve Sizing	8
Vibration	11
Weights	11
Dimensions	13
How to Order (Electric Valve)	14
How to Order (Pneumatic Valve)	15
Accessories	16
PID Controller 8071D, 8072D, SSR 47581... ..	16
3-Wire PT 100 Temperature Sensor 8060 ..	16
Solid State Relay Module 8073C	17
Electro Pneumatic Converter 8064A	17
Electro Pneumatic Converter 8064C	18
Pneumatic Indicator Controller SG80	18

3-Way Temperature Control Valve - Models GEF and GPD

Overview

AMOT G valves are 3-way control valves consisting of a heavy duty rotary valve and either a quarter turn electric or pneumatic actuator. The valves provide a high degree of accuracy and repeatability for accurate temperature control and are equally accurate in mixing or diverting service over a wide flow range.

The heavy duty rotor design provides tight temperature control without high maintenance requirements. The system is available in three standard control configurations: electric; pneumatic; and electro-pneumatic, offering flexibility for most requirements. Designed

for high vibration service, the AMOT G valves are qualified to Lloyd's Marine Requirements for shipboard service. Valves can be directly mounted to reciprocating machinery, such as diesel engines, without vibration isolation. The heavy duty actuators are specially reinforced to provide vibration resistance.

The standard valves are suitable for a variety of fluids such as water, water/glycol, sea water, lubricating and hydraulic oils. Optional body materials are available for services involving synthetic or fire resistant oils, deionized water and ammonia or freon in oil.

Applications

Mixing Applications

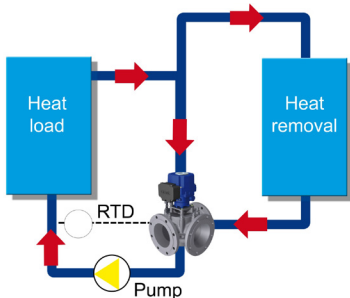

Lubricating oil temperature control is normally configured in a mixing application controlling the return temperature to the heat load. The temperature is normally measured as close as possible to the sump return.

Diverting Applications

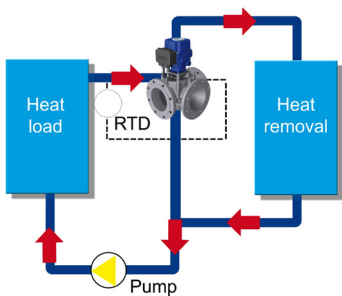

Jacket water cooling in diverting applications regulates the outlet coolant water temperature from a diesel or gas engine. The valve either sends water to a cooler or bypass loop, accurately maintaining the temperature.

The temperature is normally measured at the outlet from the heat source.

Charge Air Temperature Control

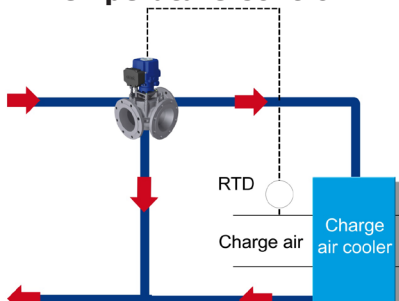

The intercooler is used to cool high temperature turbo charger air.

In this application the G Valve regulates the flow of cooling water through an intercooler, increasing efficiency, enhancing performance and helping to meet today's environmental requirements.

3-Way Temperature Control Valve - Models GEF and GPD

System Types

Electric Valve



For the electric valve, the actuator of the G valve assembly uses an electric motor which rotates in either direction in response to the ON-OFF signals received. The motor drives a gearbox connected to the rotor shaft and turns the valve rotor clockwise or counter-clockwise, a maximum of 90 degrees. At the end of travel, limit switches are incorporated to isolate the electrical supply to the motor when the valve rotor has reached either end of the rotation. A feedback potentiometer is standard and provides position indication to the control system.

The electric actuator is a rugged, compact and lightweight quarter turn actuator having enclosure protection to IP65.

The actuator is powered by an electric motor driving a worm-type gearbox. The worm gearbox prevents reverse drive due to fluid forces. It is fitted with manual override as standard, enabling valve operation without power.

A thermal cutout is fitted preventing overheating. Limit switches at each end of stroke disconnect motor power when end stroke is reached. These can also be used for remote indication.

Electric System

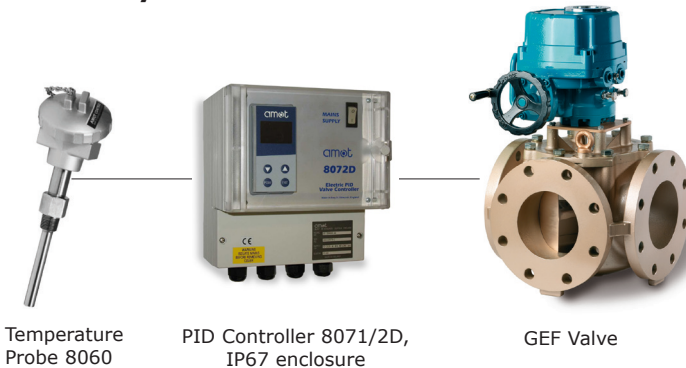

Temperature Probe 8060

PID Controller 8071/2D, IP67 enclosure

GEF Valve

The electric valve system incorporates the use of an electrically actuated three-way control valve with an electronic controller. The 8071D PID Controller can be either panel or wall mounted (see page 16 for more information). The system is completed with a temperature sensor type 8060 (see page 16 for details).

The electric G Valve system is simple to install with standard four core cable, and provides more accurate measurement and control than typical pneumatically operated systems.

3-Way Temperature Control Valve - Models GEF and GPD

System Types continued

Pneumatic Valve

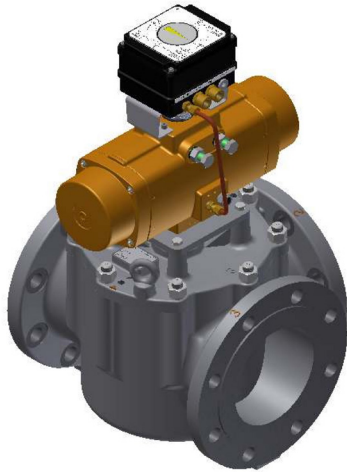

Pneumatic GPD Valve

The pneumatic valve uses a spring return pneumatic actuator and positioner to control the rotation of the valve in response to an input signal from a pneumatic or electro-pneumatic control system. The pneumatic control system sends a pneumatic signal ranging from 3 to 15 psi to the actuator to correctly position the valve at the desired temperature setting. The pneumatic control system usually consists of a P+I pneumatic controller, sensor and the necessary air supply conditioning equipment (regulators, filters and water traps).

The pneumatic actuator is a rugged, quarter turn, double piston actuator operating on a scotch yoke principle.

The actuator is fitted with spring return as standard allowing fail-safe configuration if necessary. It is also fitted with a valve positioner enabling accurate and repeatable movement.

Pneumatic System



SG80 Temperature Controller and Sensor

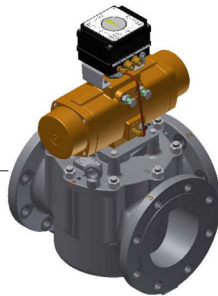

GPD Valve

The pneumatic valve system incorporates a pneumatically actuated three-way control valve with controller and integral temperature sensor, the SG80, which can be panel or wall mounted. For more information on the SG80, see page 18. The pneumatic G valve system is ideal when there is a lack of electricity or when a fail-safe system is needed.

Electro-Pneumatic System



Temperature Probe 8060



Temperature Controller 8071D



Electro-Pneumatic Converter 8064A

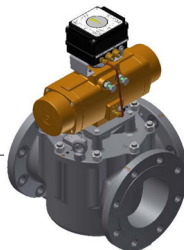

GPD Valve

The electro-pneumatic valve system combines both electric and pneumatic technology, consisting of a pneumatically actuated three-way control valve with an electro-pneumatic converter, type 8064A. See page 17 for more details.

The probe sends a resistance signal to the electronic controller, which in turn sends a 4 to 20mA signal to an I/P converter that converts this to a pneumatic signal.

The electro-pneumatic system combines the features and functionality of the AMOT electronic control system with the fail-safe action benefits of a pneumatically actuated valve.

3-Way Temperature Control Valve - Models GEF and GPD

Overview of Valve Body



Valve Body

Key features and benefits

- Lightweight and compact
- Configurable ports - allowing flexibility on installation
- Low pressure drop - enables savings on either valve or pump size
- High accuracy providing better temperature control

Specification

Flow to:	3000m ³ /hr	(13,200 us gpm)
Sizes:	50mm to 400mm	(2" to 16")
Body materials:	Cast iron (BS: 1452 250)	For fresh water, lubricating oils
	Bronze (BS: 1400 LG2)	For seawater, shock resistance, or magnetic permeability
	Steel (BS: 3100 A1)	For high strength and high pressure ratings
	Ductile iron (BS: 2789 SNG 420/12)	High performance iron
	Stainless steel (BS: 3100 316C16F)	Corrosive and special applications
Rotor material:	Bronze or stainless steel	
Rotor shaft:	Stainless steel	
Shaft seal material:	Viton rubber (GEF)	Nitrile or Viton (GPD)
Flanges:	Most DIN, ANSI and JIS standards	
Maximum internal valve pressure:	Cast iron, ductile iron or bronze	10 bar (145 psi)
	Steel and stainless steel	16 bar (232 psi)
Maximum temperature of fluid:	100°C	(212°F)
	Refer to AMOT for higher temperature requirements	

3-Way Temperature Control Valve - Models GEF and GPD

Specification: modes of operation

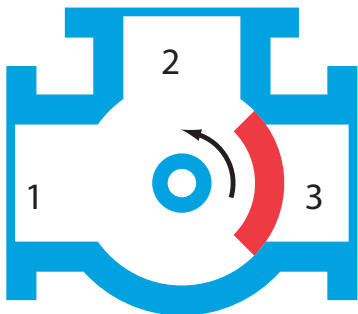

The unique construction of the AMOT G valve provides total flexibility by allowing you to select the valve port positions most ideally suited to meet your application requirements. There are two main types of mode of operation:

1. 90 degree rotor that allows either ports 1 or 3 to be selected as the common port.
2. 180 degree rotor that requires port 2 to be the common port.

Arrow indicates valve movement with increasing temperature or mA, as viewed from above (see diagram).

	Electric actuator (basic actuator codes A & B)		Pneumatic actuator direct acting			Pneumatic actuator reverse acting		
	Cold position	Hot position	3 PSI (cold)	15 PSI (hot)	No signal	15 PSI (cold)	3 PSI (hot)	No signal
Mode 32								
Mode 21								
Mode 12								
Mode 23								
Mode 13								
Mode 31								

Note: Modes 13 and 31 are not available for models 12" (DN300), 14" (DN350) & 16" (DN400)

3-Way Temperature Control Valve - Models GEF and GPD

Valve Sizing (Metric units)

Valve selection curves for valves with 90° rotor. For valves with 180° rotor multiply pressure drops by 2.

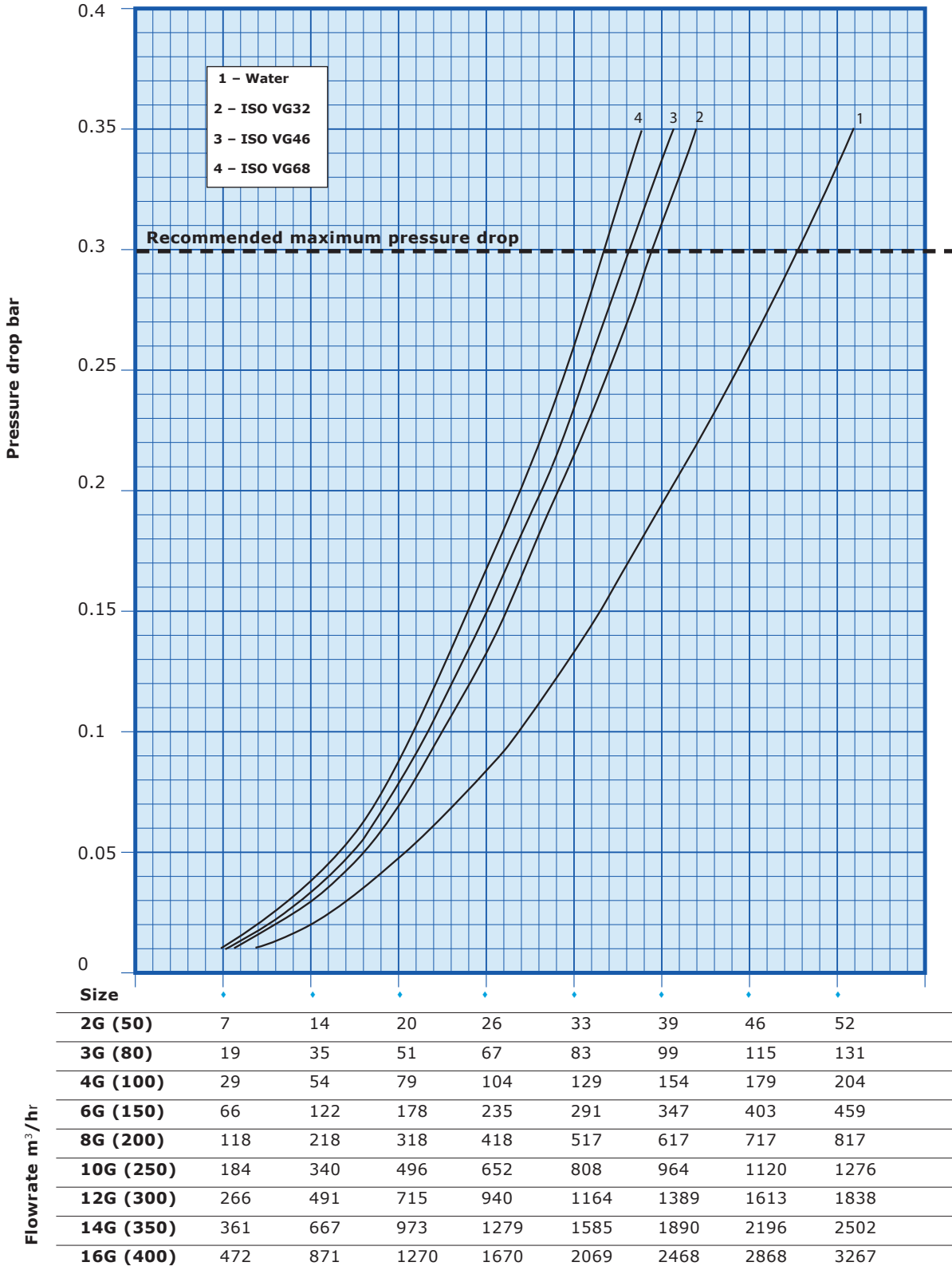

3-Way Temperature Control Valve - Models GEF and GPD

Valve Sizing (English units)

Valve selection curves for valves with 90° rotor. For valves with 180° rotor multiply pressure drops by 2.

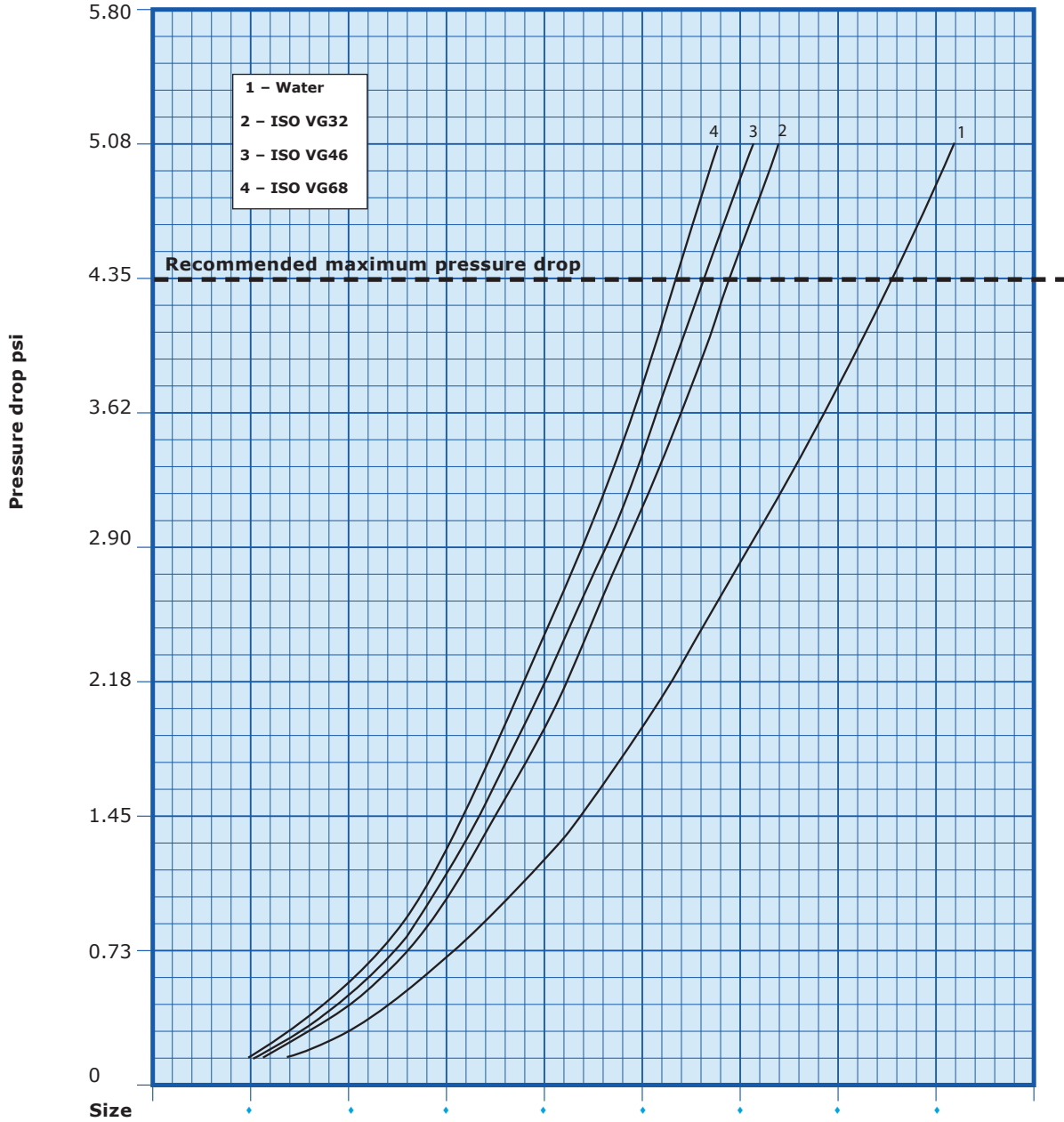

Size	31	62	88	114	145	172	203	229
2G (50)	31	62	88	114	145	172	203	229
3G (80)	84	154	225	295	365	436	506	577
4G (100)	128	238	348	458	568	678	788	898
6G (150)	291	537	784	1035	1281	1528	1774	2021
8G (200)	520	960	1400	1840	2276	2717	3157	3597
10G (250)	810	1497	2184	2871	3558	4244	4931	5618
12G (300)	1171	2162	3148	4139	5125	6116	7102	8092
14G (350)	1589	2937	4284	5631	6979	8321	9669	11016
16G (400)	2077	3832	5588	7348	9104	10859	12619	14375

3-Way Temperature Control Valve - Models GEF and GPD

Valve Sizing

Viscosity Correction

Example:

From the graph below:

100 cSt = correction factor of 0.68

$0.68 \times \text{flow coefficient} = \text{corrected flow coefficient (Kv or Cv)}$

Some approximate viscosities (cSt) of SAE oils at 40°C (110°F) are shown below, based on leading oil manufacturers published data.

For the selection of valves for more viscous fluids than water, the following must be calculated:

Viscosity: Find the viscosity of the fluid in which the valve is to operate. The viscosity is normally expressed in centistokes. Where ISO oil is used, the grade number is also the viscosity eg ISO VG46 is 46 centistokes at 40°C (104°F).

Viscosity correction: By using the correction graph below, the flow coefficient correction factor can be established. The correction figure obtained from the graph should then be multiplied by the original flow coefficient which can then be used in the standard valve sizing formulae.

Viscosity Correction Curve (Fv)

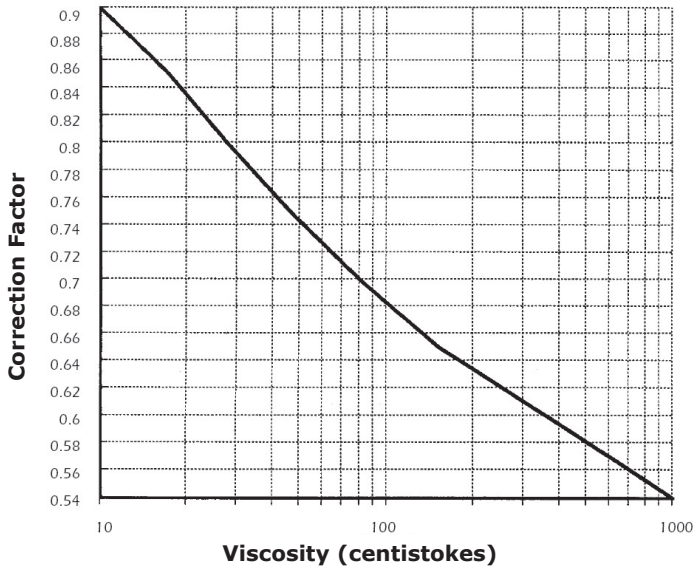

Some approximate viscosities (cSt) of SAE oils at 40°C (104°F) are shown below, based on leading oil manufacturers' published data.

SAE Oil Viscosities

Engine oils	
Oil	cSt
SAE 5W	6.8
SAE 10W	32
SAE 20	46
SAE 20W	68
SAE 30	100
SAE 40	150
SAE 50	220

Gear oils	
Oil	cSt
SAE 75W	22
SAE 80W	46
SAE 85W	100
SAE 90	150
SAE 140	460

3-Way Temperature Control Valve - Models GEF and GPD

Valve Sizing

Valve Sizing Calculations

Valve Flowrate

See the table below for examples of Kv and Cv:

Valve Type and size (DN)	2G 50	3G 80	4G 100	6G 150	8G 200	10G 250	12G 300	14G 350	16G 400
Kv	82	207	323	729	1296	2025	2918	3972	5187
Cv	96	242	378	851	1513	2364	3405	4635	6053

Pressure Drop

The G valve is designed to produce minimal pressure drop. The normal recommendation when determining the size of an AMOT G valve is a pressure drop between 0.01 and 0.3 bar (0.15 and 4.5 psi). **Note:** Kv and Cv values are applicable to 90° rotor versions only.

Kv is the flow coefficient in metric units. It is defined as the flow rate in cubic meters per hour (m³/h) of water at a temperature of 16° celsius with a pressure drop across the valve of 1 bar. Cv is the imperial coefficient. It is defined as the flow rate in US Gallons per minute [gpm] of water at a temperature of 60° fahrenheit with a pressure drop across the valve of 1 psi. (Kv = 0.865 Cv / Cv = 1.156 Kv)

The basic formula to determine the Kv of a valve is:

$$Kv = Q \sqrt{\frac{SG}{Dp}}$$

Q = Flow (m³/h)
 Dp = Pressure drop (bar)
 SG = Specific gravity of fluid
 Kv = Valve flow coefficient

There are two other ways that this formula can be used to find the flow in m³/h or pressure drop of a valve in bar:

$$Q = Kv \sqrt{\frac{Dp}{SG}} \quad Dp = \left[\frac{Q}{Kv} \right]^2 SG$$

The basic formula to determine the Cv of a valve is:

$$Cv = Q \sqrt{\frac{SG}{Dp}}$$

Q = Flow (US gallons/min)
 Dp = Pressure drop (psi)
 SG = Specific gravity of fluid
 Cv = Valve flow coefficient

There are two other ways that this formula can be used to find the flow in US gallons/minute or pressure drop of a valve in PSI:

$$Q = Cv \sqrt{\frac{Dp}{SG}} \quad Dp = \left[\frac{Q}{Cv} \right]^2 SG$$

Valve Bypass Flowrates

The AMOT G Valve is not a tight shutoff valve. When used in a reasonably balanced pressure system there will be some small amounts of leakage between ports. The actual amount of leakage will vary with the pressure difference between these ports. Consult AMOT for further information if the application is sensitive to leakage rates or if high pressure differences are likely to occur.

3-Way Temperature Control Valve - Models GEF and GPD

Vibration

Exceeds the requirements of Lloyd's Register Type Approval System, Test Specification Number 1, 2002, Vibration Test 2.

For both electric and pneumatic:

Frequency range	Displacement	Acceleration	Lloyd's
5 - 25 Hz	+/- 1.6mm		+/- 1.6mm
25 - 100 Hz		+/-5.0g (49 m/s ²)	+/- 4.0g (39 m/s ²)
100 - 300 Hz		+/- 1.0G (9.81 m/s ²) 90 minute	No requirement

Weight

Approximate weight of pneumatic valve/actuator Kg (lbs)

Material	2GPD	3GPD	4GPD	6GPD	8GPD	10GPD	12GPD	14GPD	16GPD
Cast Iron	20 (43)	36 (65)	48 (75)	82 (184)	142 (319)	183 (411)	289 (649)	429 (964)	583 (1310)
Bronze	22 (47)	39 (72)	55 (90)	96 (216)	160 (360)	205 (460)	313 (703)	479 (1076)	679 (1525)

Approximate weight of electric valve/actuator Kg (lbs)

Material	2GEF	3GEF	4GEF	6GEF	8GEF	10GEF	12GEF	14GEF	16GEF
Cast Iron	32 (71)	48 (106)	60 (132)	86 (193)	146 (328)	187 (420)	295 (663)	435 (977)	575 (1292)
Bronze	34 (75)	51 (112)	67 (148)	100 (225)	164 (368)	209 (470)	319 (717)	485 (1089)	671 (1507)

3-Way Temperature Control Valve - Models GEF and GPD

Valve dimensions

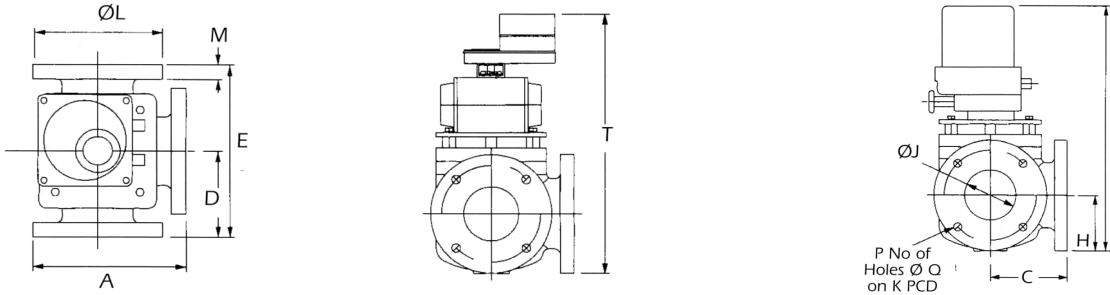

Valve size nominal bore mm (inches)

Dimension/Connection	2G	3G	4G	6G	8G	10G	12G	14G	16G	
A	197.5 (7.776)	240 (9.449)	260 (10.236)	327 (12.874)	395 (15.551)	469 (18.465)	574 (22.598)	624 (24.567)	706 (27.795)	
C	115 (4.528)	140 (5.512)	150 (5.906)	185 (7.284)	225 (8.858)	260 (10.236)	300 (11.811)	340 (13.386)	385 (15.158)	
D	115 (4.528)	140 (5.512)	150 (5.906)	185 (7.284)	225 (8.858)	260 (10.236)	300 (11.811)	340 (13.386)	385 (15.158)	
E	230 (9.055)	280 (11.024)	300 (11.811)	370 (14.567)	450 (17.717)	520 (20.472)	600 (23.622)	680 (26.772)	770 (30.315)	
F	386 (15.2)	421 (16.57)	477 (18.78)	567 (22.32)	676 (26.61)	783 (30.82)	902 (35.51)	1017 (40.04)	1093 (43.03)	
H	82.5 (3.248)	100 (3.937)	126 (4.961)	142 (5.590)	170 (6.692)	252 (9.921)	297 (11.693)	339 (13.347)	378 (14.882)	
ØJ	50 (1.969)	80 (3.150)	100 (3.937)	150 (5.906)	200 (7.874)	250 (9.843)	300 (11.811)	350 (13.780)	400 (15.748)	
K	PN 6	110 (4.3)	150 (5.9)	170 (6.7)	225 (8.8)	280 (11)	335 (13)	395 (15.5)	445 (17.5)	495 (19.4)
	PN 10	125 (4.912)	160 (6.299)	180 (7.087)	240 (9.449)	295 (11.614)	350 (13.714)	400 (15.748)	460 (18.110)	515 (20.276)
	PN 16	125 (4.921)	160 (6.299)	180 (7.087)	240 (9.449)	295 (11.614)	355 (13.967)	410 (16.142)	470 (18.504)	525 (20.670)
	ASA 125 Ib	120.6 (4.748)	152.4 (6.000)	190.5 (7.500)	241.3 (9.500)	298.5 (11.750)	361.95 (14.250)	431.8 (17.00)	467.3 (18.750)	539.75 (21.250)
	JIS 5K	—	—	165 (6.5)	230 (9)	280 (11)	—	390 (15.3)	—	—
	JIS 10K	—	—	175 (6.9)	240 (9.4)	290 (11.4)	—	—	—	—
ØL	165 (6.496)	200 (7.878)	220 (8.661)	285 (11.220)	340 (13.386)	405 (15.945)	460 (18.110)	520 (20.472)	580 (22.835)	
M	20 (0.787)	22 (0.866)	24 (0.945)	27 (1.062)	28 (1.102)	28 (1.102)	28 (1.102)	30 (1.181)	32 (1.260)	
P	PN 6	4	4	4	8	8	12	12	16	
	PN 10	4	8	8	8	8	12	12	16	
	PN 16	4	8	8	8	12	12	12	16	
	ASA 125 Ib	4	4	8	8	8	12	12	16	
	JIS 5K	—	—	8	8	8	—	12	—	
	JIS 10K	—	—	8	8	8	—	—	—	
Q	PN 6	14 (0.5)	19 (0.7)	19 (0.7)	19 (0.7)	19 (0.7)	18 (0.7)	22 (0.9)	22 (0.9)	22 (0.9)
	PN 10	18 (0.709)	18 (0.709)	18 (0.709)	23 (0.905)	23 (0.905)	22 (0.866)	22 (0.866)	22 (0.866)	26 (1.024)
	PN 16	18 (0.709)	18 (0.709)	18 (0.709)	23 (0.905)	23 (0.905)	26 (1.024)	26 (1.024)	26 (1.024)	30 (1.181)
	ASA 125 Ib	19 (0.748)	19 (0.748)	19 (0.748)	23 (0.905)	23 (0.905)	25.4 (1.000)	25.4 (1.000)	28.6 (1.125)	28.6 (1.125)
	JIS 5K	—	—	19 (0.7)	19 (0.7)	23 (0.9)	—	23 (0.9)	—	—
	JIS 10K	—	—	19 (0.7)	23 (0.9)	23 (0.9)	—	—	—	—
T	410 (16.4)	445 (17.5)	501 (19.7)	627 (24.7)	696 (27.4)	803 (31.6)	945 (37.2)	1060 (41.7)	1138 (44.80)	

3-Way Temperature Control Valve - Models GEF and GPD

How to Order (Electric actuated valve)

Use the tables below to select the unique specification of your GEF Valve.

Please select one characteristic from each section. Each characteristic is associated with a code that you will need to state when ordering.

Valve size	Code	✓
2 inch (DN50)	2	
3 inch (DN80)	3	
4 inch (DN100)	4	
6 inch (DN150)	6	
8 inch (DN200)	8	
10 inch (DN250)	10	
12 inch (DN300)	12	
14 inch (DN350)	14	
16 inch (DN400)	16	

Type	Code	✓
Electric actuation	GEF	✓

Body and seal material	Code	✓
Cast iron and Viton	C*	
Bronze and Viton	B	
Ductile iron and Viton	D	
Steel – not 12" (DN300), 14" (DN350) and 16" (DN400) and Viton	S	
Stainless steel – not 12" (DN300), 14" (DN350), and 16" (DN400) and Viton	R	

Connections	Code	✓
Flanged PN6	A	
Flanged PN10	B	
Flanged PN16	C	
Flanged ANSI 125lb	F	
Flanged ANSI 150lb	J	
JIS 10k	L	
JIS 5k	M	

* AMOT reserves the right to substitute a ductile iron product in place of cast iron to meet customer delivery requirements.

Basic actuator	Code	✓
200/240V ac electric – GEF only	A	
110/120V ac electric – GEF only	B	

Actuator options	Code	✓
Standard – For detailed information see separate datasheet 05VA	0	
5K OHM potentiometer	1	
4-20mA electronic positioner with position retransmit	A	
4-20mA electronic positioner with input retransmit	B	
4-20mA electronic positioner with position error output (4mA ref) (GEF)	C	
4-20mA electronic positioner with position error output (12mA ref) (GEF)	D	
As 'A' but reverse acting	E	
As 'B' but reverse acting	F	
As 'C' but reverse acting	G	
As 'D' but reverse acting	H	
Switched live control with position retransmit (4mA at ACW)	J	
As 'J' but reverse acting (4mA at CW)	K	

Mode of operation (movement with rising temperature, see page 7)	Rotor type	Code	✓
Anti clockwise port 3 to port 2	Standard 90°	32	
Anti clockwise port 2 to port 1	Standard 90°	21	
Clockwise port 1 to port 2	Standard 90°	12	
Clockwise port 2 to port 3	Standard 90°	23	
Anti clockwise port 1 to port 3	180° (2", 3", 4", 6", 8" & 10" only)	13	
Clockwise port 3 to port 1	180° (2", 3", 4", 6", 8" & 10" only)	31	

3-Way Temperature Control Valve - Models GEF and GPD

How to Order (Pneumatic actuated valve)

Use the tables below to select the unique specification of your GPD Valve.

Please select one characteristic from each section. Each characteristic is associated with a code that you will need to state when ordering.

Valve size	Code	✓
2 inch (DN50)	2	
3 inch (DN80)	3	
4 inch (DN100)	4	
6 inch (DN150)	6	
8 inch (DN200)	8	
10 inch (DN250)	10	
12 inch (DN300)	12	
14 inch (DN350)	14	
16 inch (DN400)	16	

Type	Code	✓
Pneumatic actuation	GPD	✓

Body / seal material	Code	✓
Bronze and Nitrile	B	
Cast iron and Nitrile	C*	
Ductile iron and Nitrile	D	
Cast steel and Nitrile	S	
Stainless steel and Nitrile	R	
Bronze and Viton	E	
Cast iron and Viton	F*	
Ductile iron and Viton	G	
Cast steel and Viton	H	
Stainless steel and Viton	J	

Flange drilling	Code	✓
Flanged PN6	A	
Flanged PN10	B	
Flanged PN16	C	
Flanged ANSI 125lb	F	
Flanged ANSI 150lb	J	
JIS 10k	L	
JIS 5k	M	

Actuator type	Actuator port threading	Code	✓
0.21 to 1.03 Bar (3 to 15 psi) Command signal	BSP	B	
	NPT	F	
0.21 to 1.03 Bar (3 to 15 psi) Command signal with manual override	BSP	C	
	NPT	G	
Pneumatic 4 to 20mA Command signal with manual override	Contact AMOT for details.		
Pneumatic 4 to 20mA Command signal			

Type	Code	✓
Pneumatic actuation	0	✓

Valve action with rising temperature	Required control system action	Code	✓
Anticlockwise Port 3 to Port 2 Standard 90°	Direct	E	
	Reverse	N	
Anticlockwise Port 2 to Port 1 Standard 90°	Direct	F	
	Reverse	P	
Clockwise Port 1 to Port 2 Standard 90°	Direct	G	
	Reverse	R	
Clockwise Port 2 to Port 3 Standard 90°	Direct	H	
	Reverse	S	
Anticlockwise Port 1 to Port 3 180° (2", 3", 4", 6", 8" & 10" only)	Direct	L	
	Reverse	M	
Clockwise Port 3 to Port 1 180° (2", 3", 4", 6", 8" & 10" only)	Direct	J	
	Reverse	K	

* AMOT reserves the right to substitute a ductile iron product in place of cast iron to meet customer delivery requirements.

3-Way Temperature Control Valve - Models GEF and GPD

Accessories

PID Valve Controllers 8071/8072D and Solid State Relays 47581L001



**PID Controller
8072D**



**Solid State
Relay
47581L001**



**PID Controller
8071D**

Key features and benefits

- Fully programmable PID-based control - allows easy system configuration
- Universal inputs; RTD's, thermocouple, or standard 4-20mA signal gives maximum system design flexibility
- Can be operated in manual mode - easy maintenance and set up

For further information and how to order these products see [Datasheet_8071_2_D_47851.pdf](#)

3-Wire PT100 Temperature Sensor - 8060



**Temperature Sensor
8060**

Key features and benefits

- 3 wire RTDs - accurate temperature measurement
- Excellent long term stability
- Good linearity
- Can use standard 3-core cable

For further information and how to order this product see [Datasheet_8060_temp_sensor.pdf](#)

3-Way Temperature Control Valve - Models GEF and GPD

Accessories

Solid State Relay Module - 8073C



**Relay Module
8073C**

Key features and benefits

- IP67 enclosure
- Alternative to using two SSRs type 47581L001
- Good linearity
- Can use standard 3-core cable

The 8073C relay module incorporates two solid state relays with terminations in an IP67 enclosure. The 8073C is designed to be used with the 8071D controller logic outputs to drive voltages for the electrically actuated G valve. Features include: zero-crossing switching, relay and logic level inputs and IP67 enclosure.

Typical Applications

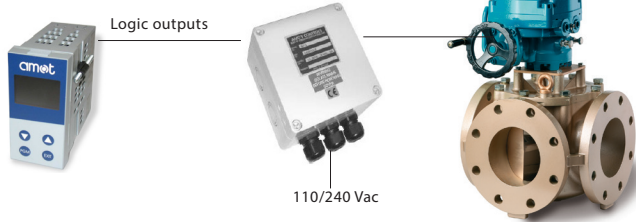

Interface with 8071D controller

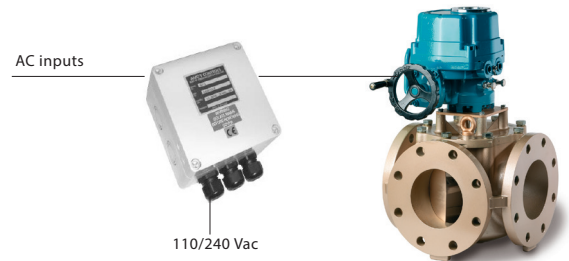

Interface with AC input signals

For further information and how to order this product see [Datasheet_8073C_SSR.pdf](#)

Electro-Pneumatic Converter - 8064A

Typical Application



**Electro-Pneumatic
Converter - 8064A**

Key features and benefits

- High vibration resistance - Lloyds 4G
- Suitable for longer pipe runs
- Fully adjustable for optimised system operation
- ATEX hazardous area certification



Temperature
Probe
8060

Temperature
Controller
8071D

Electro-Pneumatic
Converter
8064A

G Valve

For further information and how to order this product see [Datasheet_8064A_C_elect_pneu_converter.pdf](#)

3-Way Temperature Control Valve - Models GEF and GPD

Accessories

Electro-Pneumatic Converter - 8064C

Typical Application



Electro-Pneumatic Converter - 8064C

Key benefits - 8064C

- Accepts high supply pressure - avoids use of additional regulator
- Factory set for ease of installation
- Low cost alternative to 8064A
- ATEX hazardous area certification

Electro-pneumatic system

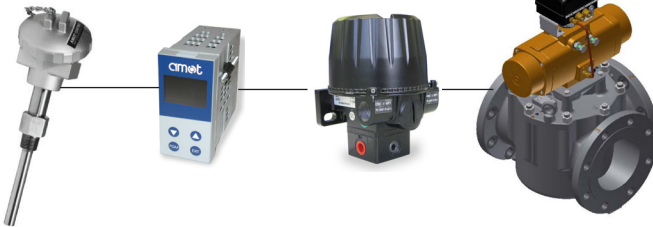

Temperature probe 8060

Temperature controller 8071D

Electro-pneumatic converter 8064C

G valve

For further information and how to order this product see [Datasheet_8064A_C_elect_pneu_converter.pdf](#)

Pneumatic Indicator Controller - SG80



Pneumatic Indicator Controller SG80

Key features and benefits

- Complete stand alone controller, no other control components required - reduced system cost
- Easily removable components - low maintenance
- Good dynamic response - gives optimum engine performance
- Compatible with every type of pneumatic valve - flexible

Typical Application

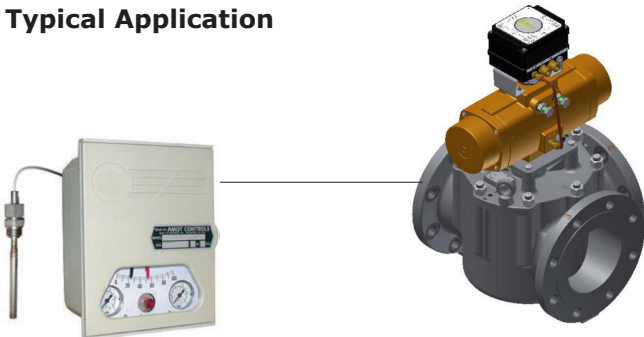

SG80 Temperature Controller and Sensor

G Valve

For further information and how to order this product see [Datasheet_SG80_Pneu_Ind_Controller.pdf](#)

Americas

AMOT USA
8824 Fallbrook Dr
Houston
TX 77064
USA

Tel: +1 (281) 940 1800
Fax +1 (713) 559 9419
Email customer.service@amot.com

Asia Pacific

AMOT Shanghai
Bd. 7A, No 568
Longpan Rd, Malu Jiading
Shanghai 201801
China

Tel +86 (0) 21 5910 4052
Fax +86 (0) 21 5237 8560
Email shanghai@amot.com

Europe and Africa

AMOT
Western Way
Bury St Edmunds
Suffolk, IP33 3SZ
England

Tel +44 (0) 1284 762222
Fax +44 (0) 1284 760256
Email info@amot.com

AMOT Controls GmbH
Rondenbarg 25
22525 Hamburg
Germany

Tel +49 (0) 40 8537 1298
Fax +49 (0) 40 8537 1331
Email germany@amot.com



WARNING

This product can expose you to chemicals including Lead, which is known to the state of California to cause cancer and birth defects or other reproductive harm. For more information go to www.P65Warnings.ca.gov.